

# 2012

HXP  
LITHIUM ION

**LIFETIME**

TOOL  
WARRANTY



FULL LINE CATALOG

**HITACHI**  
Inspire the Next



**DS18DVC**  
18V Driver Drill (1.2Ah)

Page 11



**DV18DSFL**  
18V Lithium Ion Hammer Drill  
with Flashlight (1.5Ah)

Page 12



**C18DSLP4**  
18V Lithium Ion Circular Saw  
(Tool Body Only)

Page 13



**CJ18DSLP4**  
18V Lithium Ion Jig Saw  
(Tool Body Only)

Page 14



**GP10DL**  
12V Peak Lithium Ion Micro  
Grinder (1.5Ah)

Page 21



**KC10DKL**  
12V Peak Lithium Ion Micro Driver  
Drill & Grinder Combo Kit (1.5Ah)

Page 22



**DB3DL2**  
3.6V Lithium Ion Screwdriver  
(1.5Ah)

Page 24



**DV16VSS**  
5/8" 5.4-Amp Hammer Drill,  
2 Mode, VSR

Page 34



**DH38MS**  
1-1/2" SDS Max  
Rotary Hammer, 2 Mode

Page 38



**CR13V2**  
10 Amp Reciprocating Saw

Page 43



**CJ90VST**  
Variable Speed Jig Saw  
with Blower

Page 44



**M12VE**  
3-1/4 Peak HP Variable Speed  
Plunge Router

Page 49



**GP2S2**  
1" 4.7-Amp Die Grinder

Page 58



**CC14SFS**  
14" Portable Chop Saw

Page 59



**NR90GC2**  
3-1/2" Gas Powered Paper  
Collated Framing Nailer

Page 63



**NR90GR2**  
3-1/2" Gas Powered Plastic  
Strip Collated Framing Nailer

Page 63



**CR18DSL4**  
18V Lithium Ion Recip Saw  
(Tool Body Only)  
Page 14



**KC18DSAL**  
18V Lithium Ion Driver Drill &  
Recip Saw Combo Kit (1.5Ah)  
Page 15



**DS14DSFL**  
14.4V Lithium Ion Drill Driver  
with Flashlight (1.5Ah)  
Page 18



**WH14DBL**  
14.4V Lithium Ion Brushless  
Impact Driver (3.0Ah)  
Page 19



**DH28PC**  
1-1/8" SDS Plus Rotary  
Hammer, 3 Mode, EVS  
Page 36



**DH28PD**  
1-1/8" SDS Plus Rotary Hammer,  
3 Mode, EVS with Dust Collection  
Page 36



**DH30PC2**  
1-3/16" SDS Plus Rotary  
Hammer, 3 Mode, EVS  
Page 36



**DH38YE2**  
1-1/2" Spline Shank  
Rotary Hammer, 2 Mode  
Page 37



**G12VA**  
4-1/2" 13-Amp Variable Speed  
Angle Grinder  
Page 55



**G13SP**  
5" 7.5-Amp Angle Grinder  
Page 55



**G13VA**  
5" 13-Amp Variable Speed  
Angle Grinder  
Page 56



**G23MRP9**  
9" 15-Amp Angle Grinder  
without lock-on switch, AC/DC  
Page 58



**NC40G**  
1-1/2" Gas Powered  
Concrete Nailer  
Page 63



**NT65GA**  
2-1/2" Gas Powered 15-Gauge  
Angled Finish Nailer  
Page 63



**NT65GB**  
2-1/2" Gas Powered 16-Gauge  
Angled Finish Nailer  
Page 64



**NT65GS**  
2-1/2" Gas Powered 16-Gauge  
Straight Finish Nailer  
Page 64



**NT50GS**  
2" Gas Powered 18-Gauge  
Finish Nailer  
Page 64



**KNR90AE**  
Round Head Framing  
Combo Kit  
Page 64



**NR90AE(S)**  
3-1/2" Plastic Strip Collated  
Framing Nailer  
Page 65



**NP35A**  
1-3/8" 23-Gauge  
Pin Nailer  
Page 71



**EC1110**  
5-Gallon Wheelbarrow  
Air Compressor  
Page 76



**CS33ET14**  
14" Top Handle  
Chain Saw, 32.2 cc  
Page 81



**CS33EB16**  
16" Rear Handle  
Chain Saw, 32.2 cc  
Page 81



**CS40EA18**  
18" Rear Handle  
Chain Saw, 39.6 cc  
Page 81



**CS51EAP20**  
20" Rear Handle  
Chain Saw, 50.2 cc  
Page 81



**RB24EAP**  
23.9 cc Handheld  
Blower  
Page 85



**CG22EABSLP**  
21.1 cc Curved Shaft  
Grass Trimmer  
Page 82



**CG22EASSLP**  
21.1 cc Straight Shaft  
Grass Trimmer  
Page 82



**CG24EASPSL**  
23.9 cc Straight Shaft  
Grass Trimmer  
Page 82



**CG27EASPSL**  
26.9 cc Straight Shaft  
Grass Trimmer  
Page 83



**CG18DSDL**  
18V Lithium Ion  
Grass Trimmer (3.0Ah)  
Page 83



**CG22EADSLP**  
21.1 cc Split Shaft  
Grass Trimmer  
Page 84

## TABLE OF CONTENTS

<b>HITACHI TECHNOLOGY</b> .....	2
<b>WARRANTY</b> .....	6
<b>CORDLESS</b>	
25.2-Volt .....	10
18-Volt .....	10
14.4-Volt .....	18
12-Volt .....	20
12-Volt Peak/10.8-Volt .....	21
3.6-Volt .....	24
Measuring .....	24
<b>CORDED DRILLING &amp; FASTENING</b>	
Drills .....	26
Screwdrivers .....	27
Superdrive .....	29
Corded Impacts .....	32
<b>CONCRETE &amp; MASONRY</b>	
Corded Hammer Drills .....	34
Corded Rotary Hammers .....	35
Demolition Hammers .....	39
Masonry Saws .....	41
<b>WOODWORKING</b>	
Circular Saws .....	43
Reciprocating Saws .....	43
Jig Saws .....	44
Miter Saws .....	44
Universal Workstations .....	48
Routers .....	48
Planer .....	49
<b>SANDING &amp; POLISHING</b>	
Orbital Sanders .....	51
Belt Sanders .....	51
Disc Sanders .....	52
<b>METALWORKING</b>	
Angle Grinders .....	54
Die Grinder .....	58
Metal Cutting Saws .....	59
Rebar Cutter Bender .....	60
Shears & Nibblers .....	60
<b>PNEUMATICS</b>	
Gas Nailers .....	63
Framing .....	65
Roofing .....	67
Coil .....	68
Specialty .....	69
Finish .....	69
Staplers .....	72
Flooring Nailers/Staplers .....	73
Compressors .....	75
Fastener Program .....	77
<b>OUTDOOR POWER EQUIPMENT</b>	
Chain Saws .....	81
Grass Trimmers .....	82
Smart Fit Attachments .....	84
Blower .....	85
Generator .....	85
<b>ACCESSORIES</b>	
Saw Blades .....	86
Jig Saw Blades .....	90
Reciprocating Saw Blades .....	94
Hole Saws .....	98
Drilling & Fastening .....	99
Rotary & Demo Hammers .....	120
Abrasives and Diamond Blades .....	142
Pneumatic .....	154
Batteries & Chargers .....	160
Attachments and Carrying Cases .....	164
Outdoor Power Equipment .....	168
<b>OTHER INFORMATION</b>	
ASC List .....	170
Safety Information .....	188

## PAGE BY TOOL

C10FCE2 .....	45	DH24PC3 .....	35	G23SCY .....	58	NT50AGF .....	74
C10FCH2 .....	45	DH24PF3 .....	35	G23SR .....	57	NT50YF .....	74
C10FSB .....	45	DH25DAL .....	10	GP10DL .....	21	NT50GS .....	64
C10FSH .....	45	DH25PB .....	35	GP2S2 .....	58	NT65GA .....	63
C12FCH .....	46	DH28PC .....	36	H45FRV .....	39	NT65GB .....	64
C12FDH .....	46	DH28PD .....	36	H45MRY .....	39	NT65GS .....	64
C12LCH .....	46	DH30PC2 .....	36	H55SCK .....	39	NT65M2 .....	70
C12LDH .....	46	DH38MS .....	38	H60MRV .....	39	NT65M2(S) .....	70
C12LSH .....	47	DH38YE .....	37	H65SD2 .....	40	NT65MA4 .....	69
C12RSH .....	47	DH38YE2 .....	37	H90SE .....	40	NT65MA4(S) .....	70
C15FB .....	47	DH40FR .....	37	H90SEKIT4 .....	40	NV45AB2 .....	67
C18DL .....	13	DH40MRY .....	38	KC10DAL .....	23	NV45AB2S .....	67
C18DLP4 .....	13	DH45MR .....	38	KC10DBL .....	23	NV45AE .....	67
C18DSLP4 .....	13	DH50MRY .....	38	KC10DFL .....	22	NV45AES .....	67
C7BMR .....	43	DH50SBK .....	37	KC10DGL .....	22	NV50A1 .....	68
C7SB2 .....	43	DN12DYK .....	20	KC10DKL .....	22	NV50AA .....	68
C8FSE .....	44	DS10DFL .....	21	KC18DAL .....	16	NV50AP3 .....	69
C8FSHE .....	44	DS12DVF3 .....	20	KC18DBL .....	16	NV65AH .....	68
CC12Y .....	59	DS14DL .....	18	KC18DBLWH18P4 .....	16	NV75AG .....	68
CC14SFS .....	59	DS14DSFL .....	18	KC18DCL .....	16	NV83A2 .....	69
CE16SA .....	60	DS14DVF3 .....	18	KC18DDL .....	17	P20SBK .....	49
CG18DSDL .....	83	DS18DL .....	10	KC18DG6L .....	17	RB18DLP4 .....	15
CG22EABSLP .....	82	DS18DLP4 .....	10	KC18DHL .....	15	RB24EAP .....	85
CG22EADSLP .....	84	DS18DMR(PS) .....	11	KC18DSAL .....	15	S18SB .....	52
CG22EASSLP .....	82	DS18DSAL .....	10	KC18DVF .....	17	SB8V2 .....	51
CG24EASPSL .....	82	DS18DVC .....	11	KC18DX9L .....	18	SP18VAH .....	52
CG24EKSL .....	82	DS18DVF3 .....	11	KC18DY9L .....	17	SV12SG .....	51
CG27EASPSL .....	83	DV14DL .....	19	KM12VC .....	48	SV13YA .....	51
CGHT .....	84	DV16V .....	34	KNR90AE .....	64	SV13YB .....	51
CGMC .....	84	DV16VSS .....	34	M12SA2 .....	49	UG50Y .....	24
CGPE .....	84	DV18DL .....	11	M12V2 .....	49	UU610 .....	48
CGPS .....	84	DV18DLP4 .....	11	M12VC .....	48	UU610CZ .....	48
CJ110MV .....	44	DV18DSFL .....	12	M12VE .....	49	VB16Y .....	60
CJ18DL .....	14	DV18DVC .....	12	N2503AF .....	73	W6V4 .....	28
CJ8DLP4 .....	14	DV20VB2 .....	34	N3804AB3 .....	72	W6V4SD .....	29
CJ18DLSLP4 .....	14	E43 .....	85	N3804AB3(S) .....	72	W6VA4 .....	28
CJ90VST .....	44	EC1110 .....	76	N5008AC2 .....	72	W6VB3 .....	28
CM4SB2 .....	41	EC119SA .....	75	N5009AF .....	73	W6VB3SD .....	29
CM5SB .....	41	EC12 .....	75	N5010A .....	72	W6VM .....	27
CN16SA .....	60	EC2510E .....	76	N5021A .....	73	W8VB2 .....	28
CR10DL .....	23	EC25E .....	76	N5024A2 .....	73	WH10DCL .....	21
CR10DLP4 .....	23	EC89 .....	75	NC40G .....	63	WH10DCLP4 .....	23
CR13V2 .....	43	FDV16VB2 .....	34	NP35A .....	71	WH10DFL .....	21
CR13VBY .....	43	G10SR3 .....	54	NR65AK .....	69	WH10DL .....	23
CR18DL .....	14	G10SS .....	54	NR65AKS .....	69	WH14DBL .....	19
CR18DLP4 .....	14	G12SA3 .....	55	NR83A2 .....	65	WH14DL .....	19
CR18DLSLP4 .....	14	G12SE2 .....	55	NR83A2(S) .....	65	WH18DFL .....	13
CS33EB16 .....	81	G12SE2P9 .....	55	NR83A2(S1) .....	65	WH18DL .....	12
CS33ET14 .....	81	G12SR3 .....	54	NR83A2(Y) .....	65	WH18DLP4 .....	13
CS40EA18 .....	81	G12SS .....	54	NR83AA3 .....	66	WH18DSAL .....	12
CS51EAP20 .....	81	G12VA .....	55	NR83AA3(S) .....	66	WR14DL .....	19
D10VF .....	26	G13SC2 .....	56	NR90ADPR .....	66	WR16SA .....	32
D10VG .....	26	G13SC2P9 .....	56	NR90AD(S) .....	66	WR18DL .....	13
D10VH .....	26	G13SP .....	55	NR90AEPR .....	65	WR18DLP4 .....	13
D10YB .....	27	G13VA .....	56	NR90AE(S) .....	65	WR22SA .....	32
D13 .....	27	G18DL .....	15	NR90AF .....	67		
D13VF .....	26	G18DLP4 .....	15	NR90AF(S) .....	67		
D13VG .....	27	G18MR .....	57	NR90GC2 .....	63		
DB10DL .....	22	G18MRP9 .....	57	NR90GR2 .....	63		
DB3DL2 .....	24	G18SCY .....	57	NT32AE2 .....	71		
DH18DL .....	10	G18SR .....	57	NT32AE2(S) .....	71		
DH18DLP4 .....	10	G18SS .....	56	NT50AE2 .....	70		
DH22PG .....	35	G23MR .....	58	NT50AE2(S) .....	71		
DH24PB3 .....	35	G23MRP9 .....	58	NT50AF .....	74		

## Lithium Ion Battery Technology

High power HXP Li-ion battery technology reinvents the way the world uses cordless power tools. Three times longer run time, fade free power and almost half the weight, Hitachi HXP Batteries put the user in complete control.



**Lithium-ion**  
**2** YEAR HXP BATTERY WARRANTY | **1** YEAR HXP CHARGER WARRANTY



The Industry's Best Professional Lithium Ion Tool Warranty

See all of Hitachi's Lithium Ion cordless tools beginning on page 10.



**Fade Free Power**

Hitachi's HXP Li-ion batteries produce consistent power with no RPM slowdown unlike traditional NiMH/NiCd batteries.

**Longer Life**

Overall battery life is extended 3 times longer than NiCd + NiMH batteries

**Light Weight**

HXP Li-ion Batteries offer up to 40% less weight than standard NiCd/NiMH batteries.

**Interchangeable HXP Battery Platform (Post-Style)**

HXP Li-ion post-style batteries are designed to fit Hitachi's award winning line of DL, DMR and DVF3 14.4 / 18 Volt Cordless power tools and allows users to upgrade their existing Hitachi 14.4 / 18 Volt cordless with HXP Li-ion battery technology.

**Overcharge And Discharge Protection**

Circuit technology featured in the battery and universal charger prevents the battery from losing full power when in use and overheating when charging, ensuring a full charge each time.

**Internal Circuitry**

HXP batteries are equipped with a current interruption detection system, thermal protector and an electronic switch to protect batteries against overcharge and discharge

## 12V Lithium-ion PEAK

Hitachi's Micro Series HXP Li-ion Tools provide an initial no-load peak voltage of 12 – 12.4V. In combination with Hitachi's award winning design, the new HXP Li-ion 12V Peak tools provide superior results in a smaller package. Choose from a growing selection of micro sized tools.



See page 21 for more tools and info.

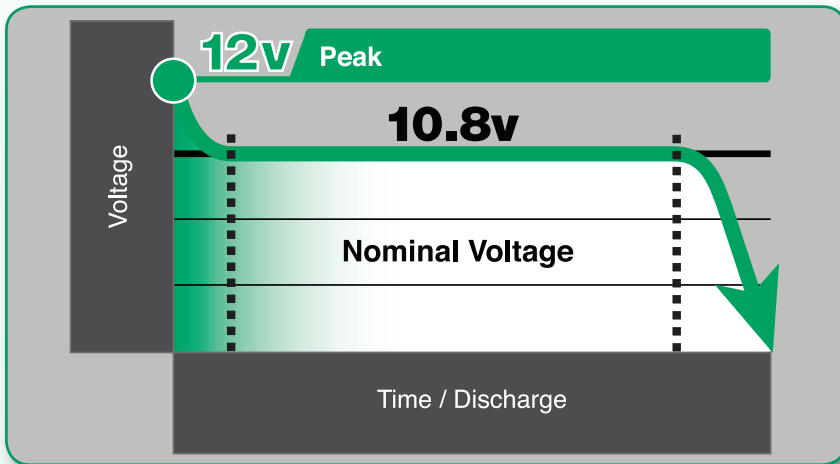

### Optimal Grip

Hitachi's unique battery cell alignment provides a more comfortable grip than competitive 12 volt tools.

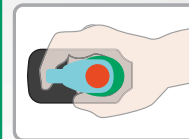

HITACHI

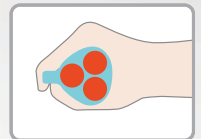

Other brands

## Brushless Motor Technology

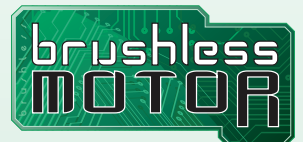

Hitachi's new brushless motor was designed with the goal of improving operating time and battery life, while also making a smaller and lighter tool. The improved efficiency results in approximately a 40% increase in the amount of work per battery charge than previous models.

See page 19 for more information on the new WH14DBL and WH14DL.

### 40% Greater Efficiency\*

Less electrical loss than conventional brush motors for greater performance.



\* When compared with conventional brushed motor models

### Smaller & Lighter

than previous brushed motor models.



NEW WH14DBL

WH14DL

### Maintenance Free

Brushless technology is dust resistant and low maintenance, eliminating the task of checking and replacing brushes.



## User Vibration Protection (UVP)

Hitachi's patented User Vibration Protection (UVP) technology significantly reduces vibration minimizing user fatigue. Hitachi's UVP tools are designed to provide maximum comfort while also delivering maximum performance.



**Rotary Hammers**  
DH50MRY  
DH40MRY



**Demo Hammer**  
H45MRY



**Angle Grinders**  
G18SCY  
G23SCY



**Reciprocating Saw**  
CR13VBY

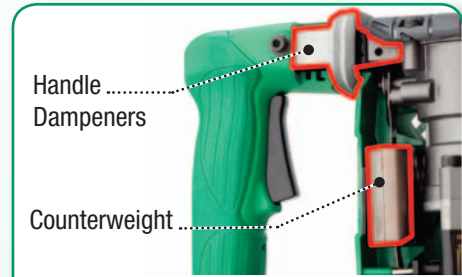

### UVP Hammers

A dynamic counterweight neutralizes vibration created by the tool while a flexible connection between the handle and tool body allow handle dampeners to reduce vibration by over 50%.\*

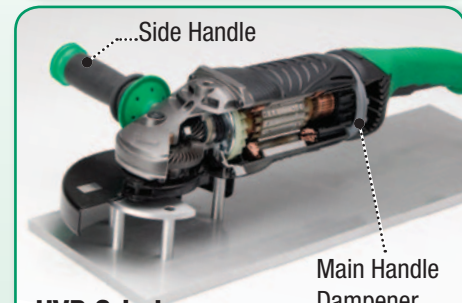

### UVP Grinders

An inner joint mechanism allows the main handle to flex at the point of connection to the main body. Vibration absorbing dampers in the main and side handles help to reduce vibration by up to 30%.\*

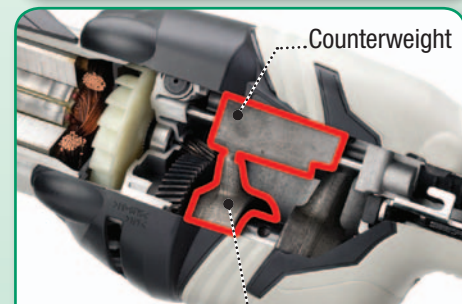

### UVP Recip Saw

The CR13VBY uses an additional wobble plate to move a counterweight opposite the movement of the blade plunger to reduce vibration by up to 65%.\*

\* Compared to standard Hitachi models



## Internal Double Insulation (IDI)

Incorporating an aluminum housing that is intertwined with an inner nylon core, Hitachi's Internal Double Insulation (IDI) technology dramatically increases tool life by combining the positive characteristics of both metal and plastic into one tool.

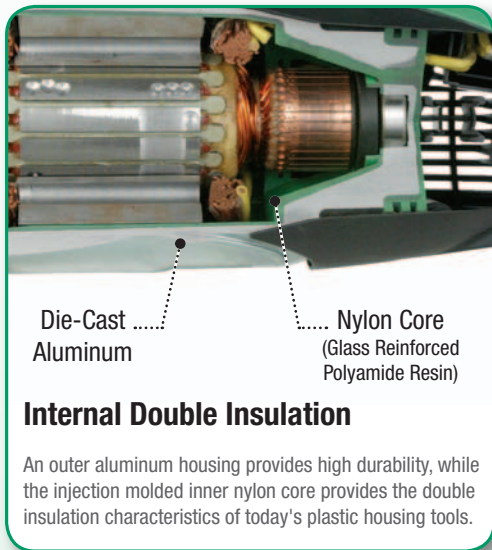

### Rotary Hammers

DH45MR  
DH40FR



### Demo Hammers

H65SD2  
H60MRV  
H45FRV



### Angle Grinders

G18MR  
G18MRP9  
G23MR  
G23MRP9



### Circular Saw

C7BMR



### Impact Wrench

WR22SA



**IDI** INTERNAL  
DOUBLE  
INSULATION

## 30-DAY SATISFACTION GUARANTEE

All Hitachi tools are inspected before they leave the factories to ensure the highest quality for customers. If you are not satisfied with any Hitachi tool within 30 days of purchase, please return the product with receipt to the original place of purchase for a refund or replacement. This guarantee covers power tools only. See the Hitachi "Limited Warranty" below for accessories and parts and further warranty information.

## PROFESSIONAL 5-YEAR LIMITED WARRANTY

This warranty of Hitachi Power Tools (hereinafter the "Hitachi Product") extends to the original purchaser of the Hitachi Product. Hitachi products are warranted to the original purchaser to be free from defect in materials and workmanship for a period of five (5) years from the original purchase date. (See exceptions below)

### EXCEPTIONS INCLUDE:

#### LIFETIME LITHIUM ION TOOL WARRANTY

The product categories listed below are warranted to the original purchaser to be free from defect in materials and workmanship for a lifetime from the original purchase date. Lifetime is defined as the serviceable life of the product. This is defined as the period during which all components are available.

- Cordless Lithium Ion Blowers • Cordless Lithium Ion Circular Saws • Cordless Lithium Ion Driver Drills • Cordless Lithium Ion Hammer Drills
- Cordless Lithium Ion Impact Drivers • Cordless Lithium Ion Impact Wrenches • Cordless Lithium Ion Jig Saws • Cordless Lithium Ion Reciprocating Saws

#### TWO YEAR WARRANTY

The product categories listed below are warranted to the original purchaser to be free from defect in materials and workmanship for a period of two (2) years from the original purchase date.

- Band Saws • Belt & Disc Sanders • Benchtop Metal Dry-Cut Saws • Drill Presses • Lithium Ion Batteries • Planers • Scroll Saws • Table Saws

#### ONE YEAR WARRANTY

The product categories listed below are warranted to the original purchaser to be free from defect in materials and workmanship for a period of one (1) year from the original purchase date.

- Air Compressors • Chargers • Concrete Cutters • Corded Grinders • Corded Hammer Drills • Corded Rotary Hammers • Cordless Gas Nailers
- Cordless Grinders • Cordless Rotary Hammers • Demolition Hammers • Digital Laser Meter • Generators • NiCd & NiMH Batteries • Radios

#### 90-DAY WARRANTY

The product categories listed below are warranted to the original purchaser to be free from defect in materials and workmanship for a period of ninety (90) days from the original purchase date.

- Bumpers • Driver Blades • Hammer Tackers • Mallet Rubber Caps • O-Rings • Piston Cushions • Ram Rubber Caps • Ram Rubber Washers • Shoe Base Pads

#### 30-DAY WARRANTY

The product category listed below is warranted to the original purchaser to be free from defect in materials and workmanship for a period of thirty (30) days from the original purchase date.

- Accessory Products

Warranty coverage is conditioned upon the purchaser furnishing Hitachi or its Authorized Service Center with adequate written proof of the original purchase date.

## OWNER'S REGISTRATION CARD

The return of the Owner's Registration Card (whether by mail or online) by the original purchaser within (10) days after the original purchase date is not a condition precedent to coverage under this warranty.

## WARRANTY COVERAGE

This Hitachi Product is warranted by Hitachi Koki U.S.A., Ltd (referred to hereinafter as "Hitachi"), 3950 Steve Reynolds Blvd. Norcross, GA 30093, against defective materials or workmanship.

This warranty is void if: defects in materials or workmanship or damages result from repairs or alterations which have been made or attempted by others or the unauthorized use of nonconforming parts; the damage is due to normal wear and tear, the damage is due to abuse (including overloading of the Hitachi product beyond capacity), improper maintenance, neglect or accident; or the damage is due to use of the Hitachi Product after partial failure or use with improper accessories.

## WARRANTY PERFORMANCE

DURING THE ABOVE WARRANTY PERIOD, SHOULD YOUR HITACHI PRODUCT EXHIBIT A DEFECT IN MATERIALS OR WORKSMANSHIP, SUCH DEFECT WILL BE REPAIRED WHEN THE COMPLETE HITACHI PRODUCT IS RETURNED, POSTAGE PREPAID AND INSURED, TO A HITACHI AUTHORIZED SERVICE CENTER. OTHER THAN THE POSTAGE AND INSURANCE REQUIREMENT, NO CHARGE WILL BE MADE FOR REPAIRS COVERED BY THIS WARRANTY.

## WARRANTY DISCLAIMERS

NO WARRANTY, ORAL OR WRITTEN, EXPRESSED OR IMPLIED, OTHER THAN THE ABOVE WARRANTY IS MADE WITH REGARD TO THIS HITACHI PRODUCT. HITACHI DISCLAIMS ANY IMPLIED WARRANTY OF MERCHANTABILITY OR FITNESS FOR A PARTICULAR USE OR PURPOSE, AND ALL OTHER WARRANTIES. IN NO EVENT SHALL HITACHI BE LIABLE FOR ANY INCIDENTAL, SPECIAL, CONSEQUENTIAL OR PUNITIVE DAMAGES, OR FOR ANY COSTS, ATTORNEY FEES, EXPENSES, LOSSES OR DELAYS ALLEGED TO BE AS A CONSEQUENCE OF ANY DAMAGE TO, FAILURE OF, OR DEFECT IN ANY PRODUCT INCLUDING, BUT NOT LIMITED TO, ANY CLAIMS FOR LOSS OF PROFITS.

## LIMITATIONS ON WARRANTY DISCLAIMERS

Some states do not allow limitations on how long an implied warranty lasts, so the above limitations may not apply to you. Some states do not allow the exclusion or limitation of incidental or consequential damages, so the above limitation or exclusion may not apply to you.

Please consult Hitachi's website [www.hitachipowertools.com](http://www.hitachipowertools.com) or call 1-800-829-4752 to locate your nearest service facility for warranty and non-warranty service on a Hitachi product.



## 10-DAY SATISFACTION GUARANTEE

All Hitachi tools are inspected before they leave the factories to ensure the highest quality for customers. If you are not satisfied with any Hitachi tool within 10 days of purchase, please return the product with receipt to the original place of purchase for a refund or replacement. This guarantee covers outdoor power equipment only. See the Hitachi "Limited Warranty" below for accessories and parts and further warranty information.

## OUTDOOR POWER EQUIPMENT LIMITED WARRANTY

Hitachi Koki U.S.A., Ltd. hereby warrants products manufactured by it or sold by it to be free from defects in material or workmanship for a period of **seven years after delivery to the first consumer end user**. "Consumer applications" are defined as all applications for household use.

Products used in commercial applications are warranted for **two years after delivery of the product to the first commercial end user**. "Commercial applications" are defined as all applications other than rental which are not considered household use.

Products used in **rental applications are warranted for one year**.

### EXCEPTIONS INCLUDE:

#### TWO YEAR WARRANTY

The product categories listed below are warranted to the original purchaser to be free from defect in materials and workmanship for a period of two (2) years from the original purchase date.

- Lithium Ion Batteries

#### ONE YEAR WARRANTY

The product categories listed below are warranted to the original purchaser to be free from defect in materials and workmanship for a period of one (1) year from the original purchase date.

- Cordless Grass Trimmers

All solid steel drive shafts utilized in Hitachi products, including split boom attachments for SmartFit® models, retailed after January 1, 2005 are warranted for life. Hitachi Koki U.S.A., Ltd. will replace, at no charge, any failed solid steel drive shaft free of charge for those models. If Hitachi Koki U.S.A., Ltd. determines that the failure of a solid steel drive shaft effectively damaged other components, those components will be covered under the terms of the warranty and will be replaced free of charge. No labor expenses will be covered for drive shaft replacement, or subsequent replacement of related parts, after the expiration of the products original warranty coverage period.

Hitachi Koki U.S.A., Ltd. warrants its ignition systems for a period of five years.

All accessories, attachments, and spare parts will carry a 90 day part replacement warranty. Provided however, normal wear parts including hoses, spark plugs, starter rope, air and fuel filters, clutch shoes, vibration isolators, throttle cables, lubricants, and all cutting attachments, etc. are not subject to this replacement warranty. Normal maintenance and adjustments to the magneto, points, carburetor, and spark plugs are not considered the responsibility of Hitachi under this warranty.

This warranty is limited to repair or replacement by Hitachi Koki U.S.A., Ltd. or at the premises of Hitachi/Tanaka Power Equipment Authorized Service Dealers, of such parts as appear to Hitachi Koki U.S.A., Ltd., upon inspection, to be defective in material and/or workmanship.

This warranty is extended to the first end user, and no warranty is made nor authorized to be made assignable on resale by the first end user.

Hitachi Koki U.S.A., Ltd. makes no warranty with respect to accessories not sold or distributed by Hitachi Koki U.S.A., Ltd. Such accessories are subject to the warranty policy of their respective manufacturers or distributors.

For the name and address of your nearest Hitachi/Tanaka Power Equipment Authorized Service Dealer, call or write to **Hitachi Koki U.S.A., Ltd. at 3950 Steve Reynolds Blvd, Norcross, GA 30093 (800) 706-7337** or visit [www.hitachipowertools.com](http://www.hitachipowertools.com).

To obtain performance of any obligation under this warranty for failure during the applicable warranty period, deliver the Hitachi product, shipping prepaid, to Hitachi Koki U.S.A., Ltd., or to the nearest Hitachi/Tanaka Power Equipment Authorized Service Dealer.

Hitachi Koki U.S.A., Ltd. reserves the right to inspect the claimed defective part(s) to determine if the malfunction is the result of a defect covered by this warranty.

This warranty will cover only defects arising under normal usage, and shall not apply, nor will Hitachi Koki U.S.A., Ltd. assume any responsibility, if the failure was caused by the following:

1. Operation of product with incorrect fuel to oil ratio
2. Misuse or abuse
3. Negligence
4. Accident or physical damage
5. Repairs made by unauthorized parties and/or with unauthorized parts
6. Improper set up or altered products
7. Improper adjustments i.e. carburetor, etc
8. Operation of engine speeds above Hitachi Koki U.S.A., Ltd. recommendations
9. Failures due to contaminated fuel
10. Failure to operate the unit in the manner specified by the "owner's manual"
11. Cutting attachments i.e. nylon line, blades, etc

ANY ACTION FOR BREACH OF ANY WARRANTY HEREUNDER MUST BE BROUGHT WITHIN A PERIOD OF SIX MONTHS FROM THE END OF THE APPLICABLE WARRANTY PERIOD.

No agent, representative, dealer, or employee of Hitachi Koki U.S.A., Ltd. has the authority to increase or alter the obligations of this warranty.

## WARRANTY DISCLAIMERS

**NO WARRANTY, ORAL OR WRITTEN, EXPRESSED OR IMPLIED, OTHER THAN THE ABOVE WARRANTY IS MADE WITH REGARD TO THIS PRODUCT. HITACHI KOKI U.S.A., LTD. DISCLAIMS ANY IMPLIED WARRANTY OF MERCHANTABILITY OR FITNESS FOR A PARTICULAR USE OR PURPOSE, AND ALL OTHER WARRANTIES. IN NO EVENT SHALL HITACHI BE LIABLE FOR ANY INCIDENTAL, SPECIAL, CONSEQUENTIAL OR PUNITIVE DAMAGES, OR FOR ANY COSTS, ATTORNEY FEES, EXPENSES, LOSSES OR DELAYS ALLEGED TO BE AS A CONSEQUENCE OF ANY DAMAGE TO, FAILURE OF, OR DEFECT IN ANY PRODUCT INCLUDING, BUT NOT LIMITED TO, ANY CLAIMS FOR LOSS OF PROFITS.**

Some states do not allow the exclusion or limitation of incidental or consequential damages, so the above limitation or exclusion may not apply to you. This warranty gives you specific legal rights, and you may also have other rights which vary from state to state.

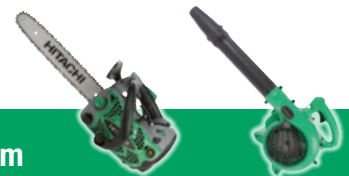

## CORDLESS QUICK REFERENCE

Voltage	1/2" Driver Drill	3/8" Driver Drill	1/4" Driver	Hammer Drill	Rotary Hammer	Impact Driver	Impact Wrench	Angle Impact Driver	Circular Saw	Reciprocating Saw	Jig Saw	Grinder	Blower	Nailer (See page 63-64)	Grass Trimmer (See page 83)	Flashlight (See page 163)	Lantern (See page 163)	Page
<b>3.6 VOLT</b>			●											●				24
<b>7.2 VOLT</b>														●				63
<b>12 VOLT PEAK</b>		●	●			●		●		●		●				●		21
<b>12 VOLT</b>		●														●		20
<b>14.4 VOLT</b>	●	●		●		●	●									●	●	18
<b>18 VOLT</b>	●			●	●	●	●		●	●	●	●	●		●	●	●	10
<b>25.2 VOLT</b>					●													10

## 18V COMBO KITS

18V Combo Kits	Battery Type	Amp Hour	1/2" Driver Drill	Hammer Drill	Rotary Hammer	Impact Driver	Impact Wrench	Circular Saw	Reciprocating Saw	Jig Saw	Grinder	Blower	Flashlight	Lantern	Page
KC18DAL	LI Post	3.0		●					●					●	16
KC18DBL	LI Post	3.0		●				●	●					●	16
KC18DBLWH18P4	LI Post	3.0		●		●		●	●					●	16
KC18DCL	LI Post	3.0		●		●									16
KC18DDL	LI Post	3.0	●			●									17
KC18DG6L	LI Post	3.0		●		●		●	●		●			●	17
KC18DHL	LI Slide	1.5	●			●							●		15
KC18DSAL	Li Slide	1.5	●						●				●		15
KC18DVF	NiCd	2.0	●					●	●				●		17
KC18DX9L	LI Post	3.0		●	●	●		●	●	●	●	●		●	18
KC18DY9L	LI Post	3.0		●	●	●	●	●	●	●	●			●	17

**NEW**

**UG50Y**

Digital Laser Meter

Details on page 24



## 12V PEAK / 10.8V COMBO KITS

12V Peak & 10.8V Combo Kits	Battery Type	Amp Hour	3/8" Driver Drill	1/4" Hex Driver	Impact Driver	Reciprocating Saw	Grinder	Flashlight	Page
KC10DAL	LI Post	1.5		●	●			●	23
KC10DBL	LI Post	1.5	●			●		●	23
KC10DFL	LI Post	1.5	●		●				22
KC10DGL	LI Post	1.5	●			●			22
KC10DKL	LI Post	1.5	●				●		22



## DH25DAL

25.2V Lithium Ion SDS Plus Rotary Hammer (3.0Ah)

*Lithium-ion*



### Features

- Compact and lightweight for greater control and less fatigue
- Two-step speed switch: Power Mode for fast and efficient drilling in large diameters and Save Mode to conserve battery power and prevent bending of small diameter bits
- Three modes of operation for greater versatility with the option of drilling only, hammering only or hammer drilling
- Factory set slip clutch protects the user and the gears in the event of a bound bit
- Idle strike restrictor prevents no-load hammering to extend tool life
- Quick set bit system for rapid changing of accessories

### Capacities

Wood	1-3/16"
Steel	1/2"
Concrete	1"

### Specifications

Volts	25.2
Shank	SDS Plus
Impact Energy	2.1 ft/lb
Modes	3
No-Load Speed	0-550 / -1,100 RPM
Impact Rate	0-2,250 / -4,500 BPM
Battery Amp Hour	3.0
Length	12-11/16"
Weight	7.9 lbs

### Includes

3.0Ah 25.2V Li-ion Battery BSL2530 (X 2)	328034
60 Minute Charger	UC36YRL
Side Handle	323155
Depth Gauge	303709
Carrying Case	329317

## DH18DL

18V Lithium Ion SDS Plus Rotary Hammer (3.0Ah)

*Lithium-ion*



Also Available:  
DH18DLP4 - Tool Body Only

### Features

- Electro-Pneumatic mechanism produces 1 ft-lb of impact energy and can drill up to 105 holes (1/4" x 1-1/4") on one charge
- Compact and lightweight - perfect for overhead drilling
- Two-step speed switch: Power Mode for fast and efficient drilling in large diameters and Save Mode to conserve battery power and prevent bending of small diameter bits
- Idle strike restrictor prevents no-load hammering to extend tool life
- Quick set bit system for rapid changing of accessories
- Convenient 5-position belt hook with LED work light

### Capacities

Wood	3/4"
Steel	1/2"
Concrete	5/8"

### Specifications

Volts	18
Shank	SDS Plus
Impact Energy	1.0 ft/lb
Modes	2
No-Load Speed	0-750 / -1,500 RPM
Impact Rate	0-3,100 / -6,200 BPM
Battery Amp Hour	3.0
Length	9-15/16"
Weight	5.1 lbs

### Includes

3.0Ah 18V Li-ion Battery EBM1830 (X 2)	326241
60 Minute Charger	UC18YRL
Side Handle	324548
Depth Gauge	303709
Carrying Case	328703

## DS18DSAL

18V Lithium Ion Compact Pro Driver Drill Kit with Flashlight (1.5Ah)

*Lithium-ion*



### Features

- Ergonomically designed handle (due to slide battery design) that eliminates the vertical battery cell chamber and keeps the handle at an optimal circumference
- Lightweight and compact at only 3.5 lbs and 7.7" in length
- 22+1 clutch offers 22 drive settings and one drill mode for both high torque applications and precision driving
- 1/2" ratcheting keyless chuck accepts a wide range of bits that can be changed out quickly and easily
- Variable speed trigger and 2-speed motor provide maximum control and precision during use
- LED job light illuminates the work surface and is ideal in dark work spaces
- Includes Hitachi's new Compact Pro Flashlight with 5-locking position and durable jobsite construction

### Specifications

Volts	18
Chuck	1/2" Keyless
Clutch Settings	22 + 1
No-Load Speed	0-350 / 1,500 RPM
Max Torque	460 in/lbs
Battery Amp Hour	1.5
Battery Type	Lithium Ion Slide
Weight	3.3 lbs

### Includes

1.5Ah 18V Li-ion Slide Battery BSL1815X (X 2)	330139
18V Compact Pro Flashlight	UB18DAL
40 Minute Charger	UC18YGSL
2-Sided #2 Phillips Bit	983006
Carrying Case	323230

## DS18DL

18V Lithium Ion Driver Drill (3.0Ah)

*Lithium-ion*



Also Available:  
DS18DLP4  
Tool Body Only

### Features

- Unique two-step switch and mechanical 2-speed gearing with variable speed trigger lets the user select from four speed settings (0-200/400/900/1600 RPM) for ultimate control
- Two-piece rare earth magnet motor provides excellent durability and power
- Convenient 5-position belt hook features an integrated LED work light
- 22+1 clutch offers 22 drive settings and one drill mode for both high torque applications and precision driving
- Lightweight at only 4.6 lbs for comfortable extended use
- 1/2" ratcheting keyless metal chuck accepts a wide range of bits that can be changed out quickly and easily

### Capacities

Wood	2"
Steel	1/2"

### Specifications

Volts	18
Chuck	1/2" Keyless
Clutch Settings	22 + 1
No-Load Speed	0-200 / 400 / 900 / 1,600 RPM
Max Torque	570 in/lbs
Battery Amp Hour	3.0
Battery Type	Lithium Ion Post
Weight	4.6 lbs

### Includes

3.0Ah 18V Li-ion Post Battery EBM1830 (X 2)	326241
45 Minute Universal Charger	UC18YRL
2-Sided #2 Phillips Bit	983006
Side Handle	323001
Carrying Case	323230

### Specifications

Volts	18
Chuck	1/2" Keyless
Clutch Settings	22 + 1
No-Load Speed	0-400 / 0-1,600 RPM
Max Torque	550 in/lbs
Battery Amp Hour	2.0
Battery Type	NiCd
Weight	5.5 lbs

### Includes

2.0Ah 18V NiCd Battery EB1820L (X 2)	322881
30 Minute Rapid Charger	UC24YFA
2-Sided #2 Phillips Bit	983006
Side Handle	323001
Carrying Case	323230

### Specifications

Volts	18
Chuck	1/2" Keyless
Clutch Settings	22 + 1
No-Load Speed	0-400 / 0-1,200 RPM
Max Torque	400 in/lbs
Battery Amp Hour	1.4
Battery Type	NiCd
Weight	4.4 lbs

### Includes

1.4Ah 18V NiCd Battery EB1814SL (X 2)	324365
35 Minute Charger	UC18YGL2
7-Piece Bit Set	
14.4/18V Flashlight	UB18D
Carrying Case	324512

### Specifications

Volts	18
Chuck	1/2" Keyless
Clutch Settings	22 + 1
No-Load Speed	0-450 / 0-1,250 RPM
Max Torque	398 in/lbs
Battery Amp Hour	1.2
Battery Type	NiCd
Weight	4.2 lbs

### Includes

1.2Ah 18V NiCd Battery BCC1812 (X 2)	324365
Battery Charger	UC18YGL2
Driver Bit	983006
Carrying Case	327727

### Specifications

Volts	18
Chuck	1/2" Keyless
Clutch Settings	22 + 1
No-Load Speed	0-200/400/900/1,800 RPM
Impact Rate	0-21,000 BPM
Max Torque	570 in/lbs
Battery Amp Hour	3.0
Battery Type	Lithium Ion Post
Weight	4.9 lbs

### Includes

3.0Ah 18V Li-Ion Post Battery EBM1830 (X 2)	326241
45 Minute Universal Charger	UC18YRL
2-Sided #2 Phillips Bit	983006
Side Handle	323001
Carrying Case	323230

### Features

- Two-piece rare-earth magnet motor provides excellent durability and power
- 1/2" keyless chuck accepts a wide range of bits that can be changed out quickly and easily
- 22+1 clutch offers 22 drive settings and one drill mode for both high torque applications and precision driving
- Lightweight at only 5.5 lbs for maximum maneuverability
- Ergonomic nose-high design, adds balance and ease of use
- Convenient 5-position belt hook features an integrated amber LED work light

### Capacities

Wood	.2"
Steel	1/2"

### Features

- Compact size and lightweight design fits easily into tight spaces
- Two speed transmission controlled by a one-touch speed knob for quick transitions
- 1/2" keyless chuck allows for quick and easy bit changes
- 22-stage clutch for high torque and/or precision driving
- Convenient belt hook features an integrated bit holder
- Comes with a convenient 14.4/18V Flashlight

### Features

- 2-speed transmission and variable speed switch for ultimate speed control
- 22+1 stage clutch settings for precise torque adjustments
- On-tool bit holder and 1/2" keyless chuck allow for convenient bit-swapping
- Non-slip ergonomic grip for increased user comfort and control
- Compact size at just 9" fits into tight spaces
- Lightweight at just 4.2 lbs for minimal fatigue after extended use

### Features

- Unique two-step switch lets the user select from four speed settings (0-200/400/900/1800 RPM) for ultimate control
- Two-piece rare earth magnet motor provides excellent durability and power
- Convenient 5-position belt hook features an integrated LED work light
- 22+2 stage adjustable clutch with 22 drive settings for optimal torque, 1 drill setting and 1 hammer drill setting
- Lightweight at only 4.9 lbs for comfortable extended use
- 1/2" ratcheting keyless metal chuck accepts a wide range of bits that can be changed out quickly and easily

### Capacities

Wood	.2"
Steel	1/2"
Brick	5/8"

## DS18DMR(PS) 18V Driver Drill (2.0Ah)



## DS18DVF3 18V Driver Drill Kit with Flashlight (1.4Ah)



## DS18DVC 18V Driver Drill (1.2Ah)



## DV18DL 18V Lithium Ion Hammer Drill (3.0Ah)

*Lithium-Ion*



Also Available:  
DV18DLP4  
Tool Body Only



## DV18DSFL

18V Lithium-Ion Hammer Drill with Flashlight (1.5Ah)

*Lithium-Ion*



### Features

- Mechanical 2-speed gearing for precision and control
- Delivers an impact rate of 0-5,600/0-21,000
- 22+2 stage adjustable clutch with 22 drive settings for optimal torque, 1 drill setting and 1 hammer drill setting
- 1/2" keyless chuck for quick tool-less bit changes
- Metal belt hook for easy accessibility
- Lightweight and compact – at just 3.7 lbs. and 9-7/32" long
- Flashlight included that features a 5-position pivoting head so that light can be aimed as needed

### Capacities

Wood	1-1/2"
Steel	1/2"
Brick	1/2"

### Specifications

Volts	18
Chuck	1/2" Keyless
Clutch Settings	22 + 2
No-Load Speed	0-400 / 1,500 RPM
Impact Rate	0-5,600 / 21,000 BPM
Max Torque	400 in/lbs
Battery Amp Hour	1.5
Battery Type	Lithium Ion Slide
Weight	3.7 lbs

### Includes

1.5Ah 18V Li-Ion Slide-Type Battery BSL1815X (X 2)	330139
Quick Charger	UC18YGSL
Flashlight	UB18DAL
Double Sided Phillips #2 Driver Bit	983006
Carrying Case	332825

## DV18DVC

18V Hammer Drill (1.4Ah)



### Features

- Two-Speed transmission and variable speed switch allow for ultimate control
- Lightweight at only 5.1 lbs for comfortable extended use
- 22+2 stage clutch for high torque and precision driving with special clutch settings for drilling and hammer-drilling
- 1/2" keyless chuck accepts a wide range of bits that can be changed out quickly and easily
- Convenient 5-Position belt hook and integrated bit holder keeps tool and accessories accessible

### Capacities

Wood	1-1/2"
Brick	1/2"
Metal	1/2"
Small Screw	1/4"
Wood Screw	#20 x 3"

### Specifications

Volts	18
Chuck	1/2" Keyless
Clutch Settings	22 + 2
No-Load Speed	0-400 / 0-1,500 RPM
Impact Rate	0-21,000 BPM
Max Torque	380 in/lbs
Battery Amp Hour	1.4
Battery Type	NiCd
Weight	5.1 lbs

### Includes

1.4Ah 18V NiCd Battery EB1814SL (X 2)	324365
30 Minute Rapid Charger	UC18VGL2
2-Sided #2 Phillips Bit	983006
Carrying Case	327727

## WH18DSAL

18V Lithium Ion Compact Pro Impact Driver (1.5Ah)

*Lithium-Ion*



### Features

- Ergonomically designed handle (due to slide battery design) that eliminates the vertical battery cell chamber and keeps the handle at an optimal circumference
- Lightweight and compact at only 3.3 lbs and 6.5" in length
- Quick change 1/4" hex chuck for simple bit replacements
- Responsive variable speed trigger for precise control during intricate operations
- LED job light illuminates the work surface and is ideal in dark work spaces

### Specifications

Volts	18
Chuck	1/4" Hex
No-Load Speed	0-2,600 RPM
Impact Rate	0-3,200 BPM
Max Torque	1,280 in/lbs
Battery Amp Hour	1.5
Battery Type	Lithium Ion Slide
Weight	3.3 lbs

### Includes

1.5Ah 18V Li-Ion Slide Battery BSL1815X (X 2)	330139
40 Minute Charger	UC18YGSL
Carrying Case	

## WH18DL

18V Lithium Ion Impact Driver (3.0Ah)

*Lithium-Ion*



Also Available:  
WH18DLP4  
Tool Body Only

### Features

- Hitachi's unique Cool Flow system minimizes the risk of motor burnout during extreme use
- Industrial grade, two-piece motor with heavy gauge copper coils for added power and durability
- Unique two-step speed switch lets the user select between Power Mode or Save Mode for ultimate control based on the application
- Convenient 5-position belt hook features an integrated LED work light
- Lightweight and compact at only 3.5 lbs and 6.3" in length
- Quick change 1/4" hex chuck for simple bit replacements

### Specifications

Volts	18
Chuck	1/4" Hex
No-Load Speed	0-2,600 RPM
Impact Rate	0-3,200 BPM
Max Torque	1,330 in/lbs
Battery Amp Hour	3.0
Battery Type	Lithium Ion Post
Weight	3.5 lbs

### Includes

3.0Ah 18V Li-Ion Battery EBM1830 (X 2)	326241
45 Minute Charger	UC18YRL
Carrying Case	323230



### Specifications

Volts	18
Chuck	1/4" Hex
No-Load Speed	0-2,500 RPM
Impact Rate	0-3,000 BPM
Max Torque	1,150 in/lbs
Battery Amp Hour	1.5
Battery Type	Lithium Ion Post
Weight	3.3 lbs

### Includes

1.5Ah 18V Li-Ion Slide Battery BCL1815 (X 2)	327330
30 Minute Rapid Charger	UC18YGL
Carrying Case	324359

### Specifications

Volts	18
Chuck	1/2" Square
No-Load Speed	0-2,600 RPM
Impact Rate	0-3,200 BPM
Max Torque	1,950 in/lbs
Battery Amp Hour	3.0
Battery Type	Lithium Ion Post
Weight	3.5 lbs

### Includes

3.0Ah 18V Li-Ion Post Battery EBM1830 (X 2)	326241
45 Minute Universal Charger	UC18YRL
Carrying Case	323230

### Specifications

Volts	18
Blade Diameter	6-1/2"
No-Load Speed	3,400 RPM
Electric Brake	Yes
Battery Amp Hour	3.0
Battery Type	Lithium Ion Post
Weight	7.1 lbs

### Includes

3.0Ah 18V Li-Ion Post Battery EBM1830 (X 2)	326241
45 Minute Charger	UC18YRL
6-1/2" 24T TCT ATB Saw Blade	725205
Rip Guide	302756
10mm Box Wrench	940543
Carrying Case	324579

### Specifications

Volts	18
Blade Diameter	6-1/2"
No-Load Speed	3,400 RPM
Electric Brake	Yes
Battery Amp Hour	3.0 or 1.5
Battery Type	Lithium Ion Slide
Weight	6.2 lbs

### Includes

6-1/2" 24T TCT ATB Saw Blade	725205
Rip Guide	302756
10mm Box Wrench	940543

### Optional

18V Li-Ion Slide Type Battery, 3.0Ah BSL1830	330067
18V Li-Ion Slide Type Battery, 1.5Ah BSL1815X	330139
14.4V-18V Li-Ion Universal Rapid Charger	UC18YRSL
Dust Collection Adapter Set	324581
6-1/2" 40T TCT ATB Saw Blade	317451

### Features

- Lightweight and compact at only 3.3 lbs and 6.9" in length
- Quick change 1/4" hex chuck for simple bit replacements
- Convenient 5-position belt hook features an integrated LED work light
- Electronic feedback provides power control for equal torque and RPM in both forward and reverse
- On tool storage for two additional bits

### Features

- Hitachi's unique Cool Flow system minimizes the risk of motor burnout during extreme use
- Industrial grade, two-piece motor with heavy gauge copper coils for added power and durability
- Unique two-step speed switch lets the user select between Power Mode or Save Mode for ultimate control based on the application
- Convenient 5-position belt hook features an integrated LED work light
- Lightweight and compact at only 3.5 lbs and 6.3" in length
- 1/2" Square drive for quick and easy socket replacements

### Features

- Left-mounted 6-1/2" blade for accessibility and convenient blade changes
- Electric brake for increased safety and precision
- Fan cooled motor for longer run times and maximum power
- Built-in spotlight for improved visibility of cut line
- Accurate cuts with 50° bevel angle adjustment for various applications
- Soft grip for improved comfort and reduced fatigue

### Capacities

Cut Depth @ 90°	2-1/4"
Cut Depth @ 45°	1-9/16"

### Features

- Left-mounted 6-1/2" blade for accessibility and convenient blade changes
- Electric brake for increased safety and precision
- Fan cooled motor for longer run times and maximum power
- Built-in spotlight for improved visibility of cut line
- Accurate cuts with 50° bevel angle adjustment for various applications
- Soft grip for improved comfort and reduced fatigue

### Capacities

Cut Depth @ 90°	2-1/4"
Cut Depth @ 45°	1-9/16"

### WH18DFL

18V Lithium Ion Impact Driver (1.5Ah)  
*Lithium-ion*



### WR18DL

18V Lithium Ion Impact Wrench (3.0Ah)  
*Lithium-ion*



Also Available:  
WR18DLP4  
Tool Body Only

### C18DL

18V Lithium Ion Circular Saw (3.0Ah)  
*Lithium-ion*



Also Available:  
C18DLP4 - Tool Body Only

### C18DSLPA

18V Lithium Ion Circular Saw  
(Tool Body Only)  
*Lithium-ion*



## CJ18DL

18V Lithium Ion Jig Saw (3.0Ah)

*Lithium-ion*



**Also Available:**  
CJ18DLP4 - Tool Body Only

### Features

- 3-Mode orbital action for most accurate and efficient cutting in various materials
- LED light for improved visibility and precise operation
- Lightweight design for comfort and maneuverability
- Tool-less blade changing system allows for quick and easy replacements
- Ergonomic D-shaped handle with soft grip prevents slippage
- Dust collection fittings for cleaner workspace

### Specifications

Volts	18
Stroke Length	1"
No-Load Speed	0-2,400 SPM
Blade Clamp	Keyless
Orbital Action	3 Modes
Battery Amp Hour	3.0
Battery Type	Lithium Ion Post
Weight	5.3 lbs

### Includes

3.0Ah 18V Li-Ion Post Battery EBM1830 (X 1)	326241
45 Minute Charger	UC18YRL
No. 41 Jig Saw Blade (1pc)	725390
4mm Hex Bar Wrench	944458
Splinter Guard	321590
Chip Cover	328352
Carrying Case	328351

### Optional

Dust Collection Adapter	321591
-------------------------	--------

## CJ18DSL4

18V Lithium Ion Jig Saw  
(Tool Body Only)

*Lithium-ion*



### Features

- 3-mode orbital action allows for accurate and efficient cuts in a variety of materials
- Tool-less blade changing system makes for quick and easy replacements
- LED light for convenient visibility and precise cuts
- 45° cutting angle adjusts to meet the application
- Lightweight at 4.5 lbs for superior control and maneuverability

### Specifications

Volts	18
Stroke Length	1"
No-Load Speed	0-2,400 SPM
Blade Clamp	Keyless
Orbital Action	3 Modes
Battery Amp Hour	3.0 or 1.5
Battery Type	Lithium Ion Slide
Weight	4.5 lbs

### Includes

No. 41 Jig Saw Blade (1pc)	725390
Splinter Guard	321590
Chip Cover	328352
4mm Hex Bar Wrench	944458

### Optional

18V Li-Ion Slide Type Battery, 3.0Ah BSL1830	330067
18V Li-Ion Slide Type Battery, 1.5Ah BSL1815X	330139
14.4V-18V Li-Ion Universal Rapid Charger	UC18YRSL
Dust Collection Adapter	321591
Plastic Carrying Case	328351

## CR18DL

18V Lithium Ion Recip Saw (3.0Ah)

*Lithium-ion*



**Also Available:**  
CR18DLP4 - Tool Body Only

### Features

- Triple sealed design protects from dust and debris, as well as water waste when cutting into pipes
- Ergonomic shape and slip/heat resistant grip for comfortable operation
- Fan cooled motor for optimum speed and added durability
- Tool-less blade changing system for quick replacements and reduced downtime
- Adjustable front shoe for depth of cut control and extended blade life
- Reversible blade setting for reverse cutting

### Specifications

Volts	18
Stroke Length	1-1/8"
No-Load Speed	0-2,100 SPM
Blade Change	Tool-less
Max Output	380W
Battery Amp Hour	3.0
Battery Type	Lithium Ion Post
Weight	7.5 lbs

### Includes

3.0Ah 18V Li-Ion Post Battery EBM1830 (X 2)	326241
45 Minute Charger	UC18YRL
Recip Saw Blade	
4mm Hex Bar Wrench	944458
Carrying Case	324313

## CR18DSL4

18V Lithium Ion Recip Saw  
(Tool Body Only)

*Lithium-ion*



### Features

- Adjustable front shoe for depth of cut control and extended blade life
- Ergonomic shape and slip/heat resistant grip for comfortable operation
- Fan cooled motor for optimum speed and added durability
- Tool-less blade change for convenience
- Battery life indicator to warn user when battery power is getting low

### Specifications

Volts	18
Stroke Length	1-1/8"
No-Load Speed	0-2,100 SPM
Blade Change	Tool-less
Battery Amp Hour	3.0 or 1.5
Battery Type	Lithium Ion Slide
Weight	6.5 lbs

### Includes

Recip Saw Blade	
4mm Hex Bar Wrench	944458

### Optional

18V Li-Ion Slide Type Battery, 3.0Ah BSL1830	330067
18V Li-Ion Slide Type Battery, 1.5Ah BSL1815X	330139
14.4V-18V Li-Ion Universal Rapid Charger	UC18YRSL
Plastic Carrying Case	330157

### Specifications

Volts	18
Wheel Diameter	4-1/2"
No-Load Speed	9,100 RPM
Spindle Thread	5/8"
Switch Type	Slide
Battery Amp Hour	3.0
Battery Type	Lithium Ion Post
Weight	4.2 lbs

### Includes

3.0Ah 18V Li-Ion Battery EBM1830 (X 1)	326241
45 Minute Charger	UC18YRL
Depressed Center Wheel	727535
Side Handle	318312
Wrench	938332Z
Carrying Case	328206

### Specifications

Volts	18
Max Air Volume	77.7 ft <sup>3</sup> /min
Battery	Accepts Hitachi 18V Post-Style

### Includes

Nozzle	328562
--------	--------

### Optional

3.0Ah 18V Li-Ion Battery EBM1830	326241
Long Nozzle Assembly	317124
Nozzle (B)	990046

### Includes

1/2" Compact Pro Driver Drill	DS18DSAL
1/4" Hex Compact Pro Impact Driver	WH18DSAL
1.5Ah 18V Li-Ion Slide Battery BSL1815X (X 2)	330139
18V Compact Pro Flashlight	UB18DAL
40 Minute Charger	UC18YGSL
Carrying Case	



### Includes

1/2" Compact Pro Driver Drill	DS18DSAL
1-1/8" Recip Saw	CR18DSAL
1.5Ah 18V Li-Ion Slide Battery BSL1815X (X 2)	330139
18V Compact Pro Flashlight	UB18DAL
40 Minute Charger	UC18YGSL
Carrying Case	



### Features

- Slim body design with soft touch grip for improved control and comfort
- Slide switch with quick off feature to immediately shut tool down for added safety
- Removable side handle improves comfort and control
- Over current protection circuit to prevent motor damage
- Spindle lock for quick and easy wheel changes
- Safety reset to prevent accidental start up

### Features

- Tool body only (compatible with all Hitachi 18V post-style batteries)
- Lightweight and compact for easy maneuverability
- Produces a max air volume of 77.7 ft<sup>3</sup>/min for powerful results
- Easy handle grip for improved control and comfort
- Wrist strap attachment to prevent accidental damage

### G18DL

18V Lithium Ion 4-1/2" Angle Grinder  
(3.0Ah)

*Lithium-ion*



Also Available:  
G18DLP4 - Tool Body Only



### RB18DLP4

18V Lithium Ion Blower  
(Tool Body Only)

*Lithium-ion*



### KC18DHL

18V Lithium Ion 3-Tool Combo Kit  
(1.5Ah)

*Lithium-ion*



### KC18DSAL

18V Lithium Ion 3-Tool Combo Kit  
(1.5Ah)

*Lithium-ion*



## KC18DAL

18V Lithium Ion 3-Tool Combo Kit  
(3.0Ah)

*Lithium-ion*



### Includes

1/2" Hammer Drill	.....	DV18DL
Reciprocating Saw	.....	CR18DL
2-Mode Lantern	.....	UB18DL
3.0Ah 18V Li-Ion Battery EBM1830 (X 2)	.....	326241
45 Minute Charger	.....	UC18YRL
Carrying Case	.....	325518

## KC18DBL

18V Lithium Ion 4-Tool Combo Kit  
(3.0Ah)

*Lithium-ion*



### Includes

1/2" Hammer Drill	.....	DV18DL
Reciprocating Saw	.....	CR18DL
6-1/2" Circular Saw	.....	C18DL
2-Mode Lantern	.....	UB18DL
3.0Ah 18V Li-Ion Batteries EBM1830 (X 2)	.....	326241
45 Minute Charger	.....	UC18YRL
Carrying Case	.....	EP9004

## KC18DBLWH18P4

18V Lithium Ion 5-Tool Combo Kit  
(3.0Ah)

*Lithium-ion*



### Includes

1/2" Hammer Drill	.....	DV18DL
Reciprocating Saw	.....	CR18DL
6-1/2" Circular Saw	.....	C18DL
1/4" Impact Driver	.....	WH18DL
2-Mode Lantern	.....	UB18DL
3.0Ah 18V Li-Ion Battery EBM1830 (X 2)	.....	326241
45 Minute Charger	.....	UC18YRL
Carrying Case	.....	EP9004

## KC18DCL

18V Lithium Ion Hammer Drill &  
Impact Driver Combo Kit (3.0Ah)

*Lithium-ion*



### Includes

1/2" Hammer Drill	.....	DV18DL
1/4" Impact Driver	.....	WH18DL
3.0Ah 18V Li-Ion Battery EBM1830 (X 2)	.....	326241
45 Minute Charger	.....	UC18YRL
Carrying Case	.....	EP9004

**Includes**

- 1/2" Driver Drill ..... DS18DL
- 1/4" Impact Driver ..... WH18DL
- 3.0Ah 18V Li-Ion Battery EBM1830 (X 2) ..... 326241
- 45 Minute Charger ..... UC18YRL
- Carrying Case ..... EP9004



**KC18DDL**  
18V Lithium Ion Driver Drill & Impact  
Driver Combo Kit (3.0Ah)  
*Lithium-ion*



Cordless

**Includes**

- 1/2" Driver Drill ..... DS18DVF3
- 6-1/2" Circular Saw ..... C18DMR
- 1-1/8" Reciprocating Saw ..... CR18DMR
- 14.4/18V Flashlight ..... UB18D
- 2.0Ah 18V NiCd Battery EB1820L (X 2) ..... 322881
- 30 Minute Rapid Charger ..... UC24YFA
- Carrying Case ..... 325518



**KC18DVF**  
18V 4-Tool Combo Kit (2.0Ah)



**Includes**

- 1/2" Hammer Drill ..... DV18DL
- 1-1/8" Reciprocating Saw ..... CR18DL
- 6-1/2" Circular Saw ..... C18DL
- 1/4" Impact Driver ..... WH18DL
- 4-1/2" Angle Grinder ..... G18DL
- 2-Mode Lantern ..... UB18DL
- 3.0Ah 18V Li-Ion Battery EBM1830 (X 2) ..... 326241
- 45 Minute Charger ..... UC18YRL
- Carrying Cases (X 2) ..... EP9004



**KC18DG6L**  
18V Lithium Ion 6-Tool Combo Kit  
(3.0Ah)  
*Lithium-ion*



G18DL Only



**Includes**

- 1/2" Hammer Drill ..... DV18DL
- SDS Plus Rotary Hammer ..... DH18DL
- 1-1/8" Reciprocating Saw ..... CR18DL
- 6-1/2" Circular Saw ..... C18DL
- 1/4" Impact Driver ..... WH18DL
- 1/2" Square Impact Wrench ..... WR18DL
- 4-1/2" Angle Grinder ..... G18DL
- Orbital Jig Saw ..... CJ18DL
- 2-Mode Lantern ..... UB18DL
- 3.0Ah 18V Li-Ion Battery EBM1830 (X 2) ..... 326241
- 45 Minute Charger ..... UC18YRL
- Carrying Cases (X 2) ..... EP9004



**KC18DY9L**  
18V Lithium Ion 9-Tool Combo Kit  
(3.0Ah)  
*Lithium-ion*



DH18DL & G18DL Only



## KC18DX9L

18V Lithium Ion 9-Tool Combo Kit  
(3.0Ah)

*Lithium-ion*



DH18DL & G18DL Only

### Includes

1/2" Hammer Drill	.....	DV18DL
SDS Plus Rotary Hammer	.....	DH18DL
1-1/8" Reciprocating Saw	.....	CR18DL
6-1/2" Circular Saw	.....	C18DL
1/4" Impact Driver	.....	WH18DL
4-1/2" Angle Grinder	.....	G18DL
Orbital Jig Saw	.....	CJ18DL
Blower	.....	RB18DL
2-Mode Lantern	.....	UB18DL
3.0Ah 18V Li-Ion Battery EBM1830 (X 2)	.....	326241
45 Minute Charger	.....	UC18YRL
Carrying Cases (X 2)	.....	EP9004

## DS14DL

14.4V Lithium Ion Driver Drill (3.0Ah)

*Lithium-ion*



### Features

- Unique two-step switch lets the user select from four speed settings (0-200/400/750/1,500 RPM) for ultimate control
- Two-piece rare earth magnet motor provides excellent durability and power
- Convenient 5-position belt hook features an integrated LED work light
- 22+1 clutch offers 22 drive settings and one drill mode for both high torque applications and precision driving
- Lightweight at only 4.4 lbs for comfortable extended use
- 1/2" ratcheting keyless metal chuck accepts a wide range of bits that can be changed out quickly and easily

### Specifications

Volts	.....	14.4
Chuck	.....	1/2" Keyless
Clutch Settings	.....	22 +1
No Load Speed	.....	0-200/400/750/1,500 RPM
Max Torque	.....	460 in/lbs
Battery Amp Hour	.....	3.0
Battery Type	.....	Lithium Ion Post
Weight	.....	4.4 lbs

### Includes

3.0Ah 14.4V Li-Ion Post Battery EBL1430 (X 2)	.....	326823
45 Minute Universal Charger	.....	UC18YRL
2-Sided #2 Phillips Bit	.....	983006
Side Handle	.....	323001
Carrying Case	.....	323230

## DS14DSFL

14.4V Lithium-Ion Drill Driver with Flashlight (1.5Ah)

*Lithium-ion*



### Features

- Mechanical 2-speed gearing for increased precision and control
- 22+1 stage adjustable clutch with 22 drive settings for optimal torque and 1 drill setting for increased control
- 3/8" keyless chuck for quick tool-less bit changes
- Metal belt hook for easy accessibility
- Lightweight and compact – at just 3.3 lbs. and 8-19/32" in length
- Flashlight included featuring a 5-position pivoting head so that light can be aimed as needed

### Specifications

Volts	.....	14.4
Chuck	.....	3/8" Keyless
Clutch Settings	.....	22 +1
No Load Speed	.....	0-450/1,250 RPM
Max Torque	.....	300 in/lbs
Battery Amp Hour	.....	1.5
Battery Type	.....	Lithium Ion Slide
Weight	.....	3.3 lbs

### Includes

1.5Ah 14.4V Li-Ion Slide-Type Batteries BSL1415X (X 2)	.....	330140
Quick Charger	.....	UC18YVSL
Flashlight	.....	UB18DAL
Double Sided Phillips #2 Driver Bit	.....	983006
Carrying Case	.....	332825

## DS14DVF3

14.4V Driver Drill Kit with Flashlight (1.4Ah)



### Features

- Compact size and lightweight design fits easily into tight spaces
- Two speed transmission controlled by a one-touch speed knob for quick transitions
- 3/8" keyless chuck allows for quick and easy bit changes
- 22-stage clutch for high torque and/or precision driving
- Convenient belt hook features an integrated bit holder
- Comes with a 14.4/18V Flashlight for convenience

### Specifications

Volts	.....	14.4
Chuck	.....	3/8" Keyless
Clutch Settings	.....	22 +1
No-Load Speed	.....	0-400/0-1,200 RPM
Max Torque	.....	300 in/lbs
Battery Amp Hour	.....	1.4
Battery Type	.....	NiCd
Weight	.....	4.0 lbs

### Includes

1.4Ah 14.4V NiCd Batteries EB1414S (X 2)	.....	324367
35 Minute Charger	.....	UC18YGL2
7-Piece Bit Set	.....	324502
14.4/18V Flashlight	.....	UB18D
Carrying Case	.....	324502

### Specifications

Volts	14.4
Chuck	1/2" Keyless
Clutch Settings	22 +1
No Load Speed	0-200/400/850/1,750 RPM
Impact Rate	0-21,000 BPM
Max Torque	460 in/lbs
Battery Amp Hour	3.0
Battery Type	Lithium Ion Post
Weight	4.6 lbs

### Includes

3.0Ah 14.4V Li-Ion Post Battery BCL1430 (X 2)	326823
45 Minute Universal Charger	UC18YRL
Side Handle	323001
2-Sided #2 Phillips Bit	983006
Carrying Case	323230

### Specifications

Volts	14.4
Chuck	1/4" Hex
No-Load Speed	0-500 / 1200 / 2000 / 2600 RPM
Impact Rate	0-3,200 BPM
Max Torque	1,300 in/lbs
Battery Amp Hour	3.0
Battery Type	Lithium Ion Slide
Weight	3.3 lbs

### Includes

3.0Ah 14.4V Li Slide Type Battery, BSL1430 (X 2)	329901
Quick Charger	UC18YGSL
Carrying Case	329440

### Specifications

Volts	14.4
Chuck	1/4" Hex
No-Load Speed	0-2,600 RPM
Impact Rate	0-3,200 BPM
Max Torque	1,240 in/lbs
Battery Amp Hour	3.0
Battery Type	Lithium Ion Post
Weight	3.3 lbs

### Includes

3.0Ah 14.4V Li-Ion Post Battery BCL1430 (X 2)	326823
45 Minute Universal Charger	UC18YRL
Carrying Case	323230

### Specifications

Volts	14.4
Chuck	1/2" Square
No Load Speed	0-2,600 RPM
Impact Rate	0-3,200 BPM
Max Torque	1,780 in/lbs
Battery Amp Hour	3.0
Battery Type	Lithium Ion Post
Weight	3.3 lbs

### Includes

3.0Ah 14.4V Li-Ion Batteries BCL1430 (X 2)	326823
45 Minute Charger	UC18YRL
Carrying Case	323230

### Features

- Unique two-step switch lets the user select from four speed settings (0-200/400/850/1750 RPM) for ultimate control
- Two-piece rare earth magnet motor provides excellent durability and power
- Convenient 5-position belt hook features an integrated LED work light
- 22+2 stage adjustable clutch with 22 drive settings for optimal torque, 1 drill setting and 1 hammer drill setting
- Lightweight at only 4.6 lbs for comfortable extended use
- 1/2" ratcheting keyless metal chuck accepts a wide range of bits that can be changed out quickly and easily

### Capacities

Brick	9/16"
-------	-------

### Features

- Features Brushless Motor Technology for increased run time, no more disposable parts to replace and longer tool life
- Powered by 3.0Ah Lithium Ion slide-type battery technology for fade free power, less weight and 3x the total battery life of traditional batteries
- Single and continuous impact modes for ultimate precision
- Four speed settings to limit power use for increased precision and control (0-500/1200/2000/2600 RPM)
- 1/4" hex chuck for quick tool-less bit changes
- Metal belt hook for easy accessibility
- Ergonomic and lightweight at just 3.3 lbs to reduce fatigue during extended or elevated use

### Features

- Hitachi's unique Cool Flow system minimizes the risk of burnout
- Industrial grade, two-piece motor with heavy gauge copper coils add power and durability
- Unique two-step speed switch lets the user select between Power Mode or Save Mode for ultimate control based on the application
- Convenient 5-position belt hook features an integrated LED work light
- Lightweight and compact at only 3.3 lbs and 6.3" in length
- Quick change 1/4" hex chuck for simple bit replacements

### Features

- Hitachi's unique Cool Flow system minimizes the risk of burnout
- Industrial grade, two-piece motor with heavy gauge copper coils add power and durability
- Unique two-step speed switch lets the user select between Power Mode or Save Mode for ultimate control based on the application
- Convenient 5-position belt hook features an integrated LED work light
- Lightweight and compact at only 3.3 lbs and 6.58" in length

### DV14DL

14.4V Lithium Ion Hammer Drill  
(3.0Ah)

*Lithium-ion*



### WH14DBL

14.4V Lithium-Ion Brushless  
Impact Driver (3.0Ah)

*Lithium-ion*



### WH14DL

14.4V Lithium Ion Impact Driver  
(3.0Ah)

*Lithium-ion*



### WR14DL

14.4V Lithium Ion Impact Wrench  
(3.0Ah)

*Lithium-ion*



## DS12DVF3

12V Driver Drill Kit with Flashlight  
(1.4Ah)



### Features

- Compact size and lightweight design fits easily into tight spaces
- Two speed transmission controlled by a one-touch speed knob for quick transitions
- 3/8" keyless chuck allows for quick and easy bit changes
- 22-stage clutch for high torque and/or precision driving
- Convenient belt hook features an integrated bit holder
- Comes with a convenient 9.6/12V Flashlight

### Specifications

Volts	12
Chuck	3/8" Keyless
Clutch Settings	22 +1
No Load Speed	0-350/0-1,050 RPM
Max Torque	230 in/lbs
Battery Amp Hour	1.4
Battery Type	NiCd
Weight	3.3 lbs

### Includes

1.4Ah 12V NiCd Batteries EB1214S (X 2)	324360
30 Minute Charger	UC18YGL2
7-Piece Bit Set	
9.6/12V Flashlight	UB12D
Carrying Case	

## DN12DYK

12V Right Angle Drill (2.0Ah)



### Features

- High performance, fan cooled motor for optimal performance in odd angle applications
- 3-3/4" low profile head for easy access in tight spaces
- 3/8" keyless chuck with ratcheting lock mechanism for greater bit retention
- Variable speed switch with braking function for control
- Push-button type reversing switch allows for quick and easy transition

### Specifications

Volts	12
Chuck	3/8" Keyless
No Load Speed	0-800 RPM
Max Torque	80 in/lbs
Battery Amp Hour	2.0
Battery Type	NiCd
Weight	3.1 lbs

### Includes

2.0Ah 12V NiCd Batteries EB1220BL (X 2)	320386
50 Minute Charger	UC14YFA
Carrying Case	321941



### Specifications

Volts	12V Peak
Chuck	3/8" Keyless
Clutch Settings	21 +1
No Load Speed	0-300/0-1,300 RPM
Max Torque	195 in/lbs
Battery Amp Hour	1.5
Battery Type	Lithium Ion Post
Weight	2.2 lbs

### Includes

1.5 Ah 12V Peak Li-Ion Batteries BCL1015 (X 2)	331065
40 Minute Charger	UC10SFLP
#2 Phillips Driver Bit	992671
Carrying Case	331450

### Specifications

Volts	12V Peak
Chuck	1/4" Hex
No Load Speed	0-2,500 RPM
Impact Rate	0-3,000 BPM
Max Torque	840 in/lbs
Battery Amp Hour	1.5
Battery Type	Lithium Ion Post
Weight	2.2 lbs

### Includes

1.5 Ah 12V Peak Li-Ion Batteries BCL1015 (X 2)	331065
40 Minute Charger	UC10SFLP
#2 Driver Bit	992671
Carrying Case	331450

### Specifications

Volts	12V Peak
Collet Chuck Capacity	1/8"
No Load Speed	5,000-35,000 RPM
Battery Amp Hour	1.5
Battery Type	Lithium Ion Post
Weight	1.06 lbs

### Includes

1.5 Ah 12V Peak Li-Ion Battery BCL1015	331065
40 Minute Charger	UC10SFLP
40 Piece Accessory Set	
Carrying Case	

### Specifications

Volts	12V Peak/10.8V
Chuck	1/4" Hex
No Load Speed	0-2,100 RPM
Max Torque	265 in/lbs
Battery Amp Hour	1.5
Battery Type	Lithium Ion Post
Weight	2.2 lbs

### Includes

1.5Ah 12V Peak Lithium Ion Battery BCL1015 (X 2)	331065
40 Minute Charger	UC10SFL
#2 Phillips Driver Bit	992671
Carrying Case	329632

### Features

- Impressively lightweight and compact design fits easily into tight spaces
- Best-in-class 21+1 clutch with 21 torque settings and a drill mode for ultimate precision and control in both forward and reverse
- LED light effectively illuminates dark work spaces
- 3/8" keyless chuck allows for quick and easy bit changes
- Free-standing design allows drill to stand on its own when not in use

### Features

- Impressively lightweight and compact design fits easily into tight spaces
- LED light effectively illuminates dark work spaces
- Quick change 1/4" hex chuck for simple bit replacements
- Responsive variable speed trigger for precise control during intricate operations
- Free-standing design allows drill to stand on its own when not in use

### Features

- 1.5Ah Lithium Ion battery for longer total battery life, lighter weight and a steady level of power throughout the charge
- Variable speed dial allows the user to control the ideal speed from 5,000 to 35,000 RPM
- Compact and lightweight – a mere 8-3/16" in length, and 1.06 lbs to fit in tight spaces
- Built-in white LED light for superior visibility even in the darkest of work spaces
- Innovative anti-vibration system for increased comfort and total control
- Slim soft grip handle increases comfort and reduces fatigue
- Low battery indicator light warns the user when run time is getting low
- Short charge time – just 40 minutes for more productivity

### Features

- Impressively compact and lightweight at only 2.2 lbs for easy maneuverability
- Quick change 1/4" hex chuck for simple bit replacements
- Angled low-profile head allows the tool to fit into hard to reach areas with ease
- LED light effectively illuminates dim work areas
- Battery charge indicator light warns the user when run time is low

### DS10DFL

12V Peak Lithium Ion Micro Driver Drill (1.5Ah)

*Lithium-Ion*



Cordless

### WH10DFL

12V Peak Lithium Ion Micro Impact Driver (1.5Ah)

*Lithium-Ion*



### GP10DL

12V Peak Lithium Ion Micro Grinder (1.5Ah)

*Lithium-Ion*



### WH10DCL

12V Peak Lithium Ion Micro Right Angle Impact Driver (1.5Ah)

*Lithium-Ion*



Also Available:  
WH10DCLP4 - Tool Body Only

## KC10DFL

12V Peak Lithium Ion Micro Driver Drill  
& Impact Driver Combo Kit (1.5Ah)

*Lithium-ion*



### Includes

- 3/8" Micro Driver Drill . . . . . DS10DFL
- 1/4" Micro Impact Driver . . . . . WH10DFL
- 1.5 Ah 12V Peak Li-Ion Batteries BCL1015 (X 2) . . . . . 331065
- 40 Minute Charger . . . . . UC10SFLP
- Carrying Case . . . . .



## KC10DGL

12V Peak Lithium Ion Micro Driver Drill  
& Recip Saw Combo Kit (1.5Ah)

*Lithium-ion*



### Includes

- 3/8" Micro Driver Drill . . . . . DS10DFL
- 1/4" Micro Reciprocating Saw . . . . . CR10DL
- 1.5 Ah 12V Peak Li-Ion Batteries BCL1015 (X 2) . . . . . 331065
- 40 Minute Charger . . . . . UC10SFLP
- Carrying Case . . . . . 330097



## KC10DKL

12V Peak Lithium Ion Micro Driver Drill  
& Grinder Combo Kit (1.5Ah)

*Lithium-ion*



### Includes

- 3/8" Micro Driver Drill . . . . . DS10DFL
- Micro Grinder . . . . . GP10DL
- 1.5 Ah 12V Peak Li-Ion Batteries BCL1015 (X 2) . . . . . 331065
- 40 Minute Charger . . . . . UC10SFLP
- Carrying Case . . . . .



## DB10DL

10.8V Lithium Ion Micro  
Driver Drill (1.5Ah)

*Lithium-ion*



### Features

- Impressively lightweight and compact design fits easily into tight spaces
- Best-in-class 21+1 clutch with 21 torque settings and a drill mode for ultimate precision and control in both forward and reverse
- LED light effectively illuminates dark work spaces
- Quick change 1/4" hex chuck for simple bit replacements
- Free-standing design allows drill to stand on its own when not in use

### Specifications

- Volts . . . . . 12V Peak/10.8
- Chuck . . . . . 1/4" Hex
- Clutch Settings . . . . . 21 +1
- No Load Speed . . . . . 0-400 RPM
- Max Torque . . . . . 88 in/lbs
- Battery Amp Hour . . . . . 1.5
- Battery Type . . . . . Lithium Ion Post
- Weight . . . . . 1.8 lbs

### Includes

- 1.5Ah 10.8V Lithium Ion Battery BCL1015 (X 2) . . . . . 329370
- 40 Minute Charger . . . . . UC10SFL
- #2 Phillips Driver Bit . . . . . 992671
- 7-Piece Bit Set . . . . .
- Carrying Case . . . . . 329585

### Specifications

Volts	12V Peak/10.8
Chuck	1/4" Hex
No Load Speed	0-2,300 RPM
Impact Rate	0-3,000 BPM
Max Torque	930 in/lbs
Battery Amp Hour	1.5
Battery Type	Lithium Ion Post
Weight	2.0 lbs

### Features

- Impressively lightweight and compact design fits easily into tight spaces
- LED light effectively illuminates dark work spaces
- Quick change 1/4" hex chuck for simple bit replacements
- Responsive variable speed trigger for precise control during intricate operations
- Free-standing design allows drill to stand on its own when not in use

### Includes

1.5Ah 10.8V Lithium Ion Battery BCL1015 (X 2)	329370
40 Minute Charger	UC10SFL
#2 Phillips Driver Bit	992671
Carrying Case	329553

### Specifications

Volts	12V Peak/10.8V
Stroke Length	1/2"
No Load Speed	0-2,700 SPM
Blade Change	Tool-less
Battery Amp Hour	1.5
Battery Type	Lithium Ion Post
Weight	2.6 lbs

### Features

- Impressively compact and lightweight at 2.6 lbs for easy maneuverability
- Conveniently accepts standard reciprocating saw blades
- Tool-less blade change makes replacing blades fast and easy
- Built-in LED light effectively illuminates dim work areas
- Battery charge indicator light warns the user when run time is low
- Responsive variable speed trigger for precise control during operation

### Includes

1.5Ah 10.8V Lithium Ion Battery BCL1015 (X 2)	329370
40 Minute Charger	UC10SFL
Recip Saw Blade	
3mm Hex Bar Wrench	943277
Carrying Case	329993

### Includes

1/4" Micro Driver Drill	.DB10DL
1/4" Micro Impact Driver	.WH10DL
Micro Flashlight	.UB10DL
1.5 Ah 12V Peak Li-Ion Batteries BCL1015 (X 2)	331065/329370
#2 Phillips Driver Bit	992671
40 Minute Charger	UC10SFL
Carrying Case	330097



### WH10DL 10.8V Lithium Ion Micro Impact Driver (1.5Ah) *Lithium-Ion*



### CR10DL 10.8V Lithium Ion Micro Reciprocating Saw (1.5Ah) *Lithium-Ion*



Also Available:  
CR10DLP4 - Tool Body Only

### KC10DAL 10.8V Lithium Ion Driver Drill & Impact Driver Combo Kit (1.5Ah) *Lithium-Ion*



### Includes

1/4" Micro Driver Drill	.DB10DL
Micro Reciprocating Saw	.CR10DL
Micro Flashlight	.UB10DL
1.5 Ah 12V Peak Li-Ion Batteries BCL1015 (X 2)	331065/329370
40 Minute Charger	UC10SFL
Carrying Case	330097



### KC10DBL 10.8V Lithium Ion Driver Drill & Recip Saw Combo Kit (1.5Ah) *Lithium-Ion*



## DB3DL2

3.6V Lithium Ion Screwdriver (1.5Ah)

*Lithium-ion*



### Features

- Dual position handle converts from straight to pistol grip for maximum flexibility
- Spindle lock for manual screw tightening
- 1/4" hex chuck for quick and easy bit changes
- Built-in LED light to illuminate the work surface
- Compact and lightweight – only 10.55" in length and weighs less than 1 lb.
- Overload and over-discharge circuit protection for higher durability

### Specifications

Volts	3.6V
Chuck	1/4" Hex
No Load Speed	200/600 RPM
Max Torque	44 in/lbs
Battery Amp Hour	1.5
Battery Type	Lithium Ion Post
Weight	0.9 lbs

### Includes

1.5Ah 3.6V Lithium Ion Batteries EBM315 (X 2)	326263
30 Minute Charger	UC3SFL
Phillips Bit	992671
Case	

## UG50Y

Digital Laser Meter



### Features

- Five measuring modes for user convenience – distance, area, volume, continuous, and indirect
- Long distance measuring range from 1.64' to 164'
- High accuracy level at  $\pm 1/16"$
- Backlit four-stage display for convenience in low-light areas
- Front and side measure buttons for convenient measuring in various positions

### Specifications

Volts	9
Max Range	164 ft
Side Measure Button	Yes
Measurement Modes	Length, Single
	Length, Continuous
	Area
	Volume
	Indirect
Backlight	Yes
Bubble Level	Yes

### Includes

Wrist Strap	
9V Battery (X 1)	
Tool Pouch	

## UG50Y Digital Laser Meter Guide



## DRILLING QUICK REFERENCE

Model	Type	Chuck Size	Amps	RPM	Torque (in-lbs)	Capacity			Weight (lbs)	Page
						Wood	Steel	Hole Saw		
D10VH	Pistol Grip	3/8" Keyless	6.0	0-2,500	108.1	1"	3/8"	n/a	3.1	26
D10VF	Pistol Grip	3/8" Keyed	9.0	0-3,000	139.0	1"	3/8"	1-1/8"	4.0	26
D10VG	Pistol Grip	3/8" Keyed	9.0	0-1,200	312.5	1-1/4"	3/8"	2-3/4"	4.2	26
D13VF	Pistol Grip	1/2" Keyed	9.0	0-850	416.6	2-1/8"	1/2"	4"	4.6	26
D13VG	Pistol Grip	1/2" Keyed	9.0	0-600	651.0	2-9/16"	1/2"	4-1/2"	4.6	27
D10YB	Right Angle	3/8" Keyed	4.6	500-2,300	106.2	7/8"	3/8"	n/a	3.3	27
D13	Spade Handle	1/2" Keyed	6.2	550	477.4	1-5/8"	1/2"	4-1/8"	7.0	27

Drilling & Fastening

## SCREWDRIVER QUICK REFERENCE

Model	Amps	RPM	Torque (in-lbs)	Screw Capacity			Applications				Page
				Drywall	Wood	Machine	Drywall	Metal Framing	Subfloor	Decking	
W6VM	6.6	0-6,000	69.4	#10	#9	1/4"	Best	Fair	Good	Good	27
W6V4	6.6	0-4,500	81.5	#10	#9	1/4"	Best	Good	Good	Good	28
W6VA4	6.6	0-3,000	112.7	#10	#9	1/4"	Better	Better	Better	Better	28
W6VB3	6.6	0-2,600	139.6	#10	#12	1/4"	Good	Best	Best	Best	28
W8VB2	6.6	0-1,700	215.1	#10	#12	5/16"	Fair	Best	Good	Good	28
W6V4SD	6.6	0-4,500	81.5	#10	#9	1/4"	Best	Good	Best	Good	29
W6VB3SD	6.6	0-2,600	139.6	#10	#12	1/4"	Good	Best	Best	Best	29

## D10VH

3/8" 6-Amp Drill, EVS, Reversible



### Features

- Lightweight and compact for greater ease of use and maneuverability
- Form fit palm grip for improved control with minimal vibration
- Variable speed dial located in switch for easy operation
- Keyless chuck offers tool-free convenience

### Capacities

Wood	.....1"
Steel	.....3/8"

### Specifications

Amp	.....6
Chuck	.....3/8" Keyless
No Load Speed	.....0-2,500 RPM
Max Torque	.....108.1 in/lbs
Weight	.....3.1 lbs

### Includes

Case	.....321635
4 Piece Drill Bit Set	.....

### Optional

Side Handle for M10	.....981205
Hook (A)	.....321612

## D10VF

3/8" 9-Amp Drill, EVS, Reversible



### Features

- Lightweight and compact for greater ease of use and maneuverability
- Electronic variable speed control trigger designed with a lock-on feature for continuous operation
- 3-jaw industrial chuck provides maximum gripping power for all types of bits and drivers
- Form fit palm grip for improved control with minimal vibration

### Capacities

Wood	.....1"
Steel	.....3/8"
Hole Saw	.....1-1/8"

### Specifications

Amp	.....9
Chuck	.....3/8" Keyed
No Load Speed	.....0-3,000 RPM
Max Torque	.....139 in/lbs
Weight	.....4.0 lbs

### Includes

Case	.....319543
Chuck Key	.....319529

### Optional

Side Handle for M10	.....981205
Hook (A)	.....317676
3/8" Keyless Chuck	.....324205

## D10VG

3/8" 9-Amp Drill, EVS, Reversible



### Features

- Lightweight and compact for greater ease of use and maneuverability
- Electronic variable speed control trigger designed with a lock-on feature for continuous operation
- 3-jaw industrial chuck provides maximum gripping power for all types of bits and drivers
- Form fit palm grip for improved control with minimal vibration

### Capacities

Wood	.....1-1/4"
Steel	.....3/8"
Hole Saw	.....2-3/4"

### Specifications

Amp	.....9
Chuck	.....3/8" Keyed
No Load Speed	.....0-1,200 RPM
Max Torque	.....312.5 in/lbs
Weight	.....4.2 lbs

### Includes

Case	.....319543
Side Handle	.....981205
Chuck Key	.....319529

### Optional

Hook (A)	.....317676
3/8" Keyless Chuck	.....324205

## D13VF

1/2" 9-Amp Drill, EVS, Reversible



### Features

- Lightweight and compact for greater ease of use and maneuverability
- Electronic variable speed control trigger designed with a lock-on feature for continuous operation
- Double gear reduction provides higher torque, while reducing gear strain
- Form fit palm grip for improved control with minimal vibration

### Capacities

Wood	.....2-1/8"
Steel	.....1/2"
Hole Saw	......4"

### Specifications

Amp	.....9
Chuck	.....1/2" Keyed
No Load Speed	.....0-850 RPM
Max Torque	.....416.6 in/lbs
Weight	.....4.6 lbs

### Includes

Case	.....319543
Side Handle	.....981205
Chuck Key	.....319527

### Optional

Hook (A)	.....317676
Angle Attachment Assembly	.....319528

### Specifications

Amp	9
Chuck	1/2" Keyed
No Load Speed	0-600 RPM
Max Torque	651 in/lbs
Weight	4.6 lbs

### Includes

Case	319543
Side Handle	981205
Handle Joint	319550
Chuck Key	319527

### Optional

Hook (A)	317676
3/8" Keyless Chuck	324205

### Specifications

Amp	4.6
Chuck	3/8" Keyed
No Load Speed	500-2,300 RPM
Max Torque	106.2 in/lbs
Weight	3.3 lbs

### Includes

Side Handle	956633
Chuck Key	319070

### Specifications

Amp	6.2
Chuck	1/2" Keyed
No Load Speed	550 RPM
Max Torque	477.4 in/lbs
Weight	7.0 lbs

### Includes

Side Handle	981205
Chuck Key	303334

### Optional

Drill Press	D13DS
Handle Joint	930886
Depth Stopper	981655Z

### Specifications

Amp	6.6
Bit Shank	1/4" Hex
No-Load Speed	0-6,000 RPM
Max Torque	69.4 in/lbs
Weight	3.1 lbs

### Includes

2-9/16" Magnetic Bit Holder	982554Z
No. 2 Phillips Driver Bit	728336B10
Sub-Stopper (F)	323351
Hook	323471

### Optional

Plastic Case	310904
--------------	--------

### Features

- Lightweight and compact for greater ease of use and maneuverability
- Electronic variable speed control trigger designed with a lock-on feature for continuous operation
- Double gear reduction provides higher torque, while reducing gear strain
- Form fit palm grip for improved control with minimal vibration

### Capacities

Wood	2-9/16"
Steel	1/2"
Hole Saw	4-1/2"

### Features

- 3-1/4" low profile head for easy access in tight spaces
- Slide switch design with trigger lock-on for continuous operation
- Small grip circumference designed for maximum maneuverability
- Lightweight and compact for greater ease of use

### Capacities

Wood	7/8"
Steel	3/8"

### Features

- 3-position side handle increases operability and control
- 2-position rear D-handle offers greater maneuverability and balance
- Industrial chuck for heavy-duty use and maintenance free operation
- Reversible drilling allows for quick removal from materials and higher efficiency

### Capacities

Wood	1-5/8"
Steel	1/2"
Hole Saw	4-1/8"

### Features

- Excellent for high-speed screw applications
- Lightweight for ease of use and maneuverability
- Silent clutch lowers noise level to 76 dB
- Removable nose-piece provides easy bit replacement and adjustments
- Belt hook convenient for in between use

### Capacities

Drywall	#10
Wood	#9
Machine	1/4"

### D13VG

1/2" 9-Amp Drill, EVS, Reversible



### D10YB

3/8" 4.6-Amp Right Angle Drill, Dial-In EVS, Reversible



### D13

1/2" 6.2-Amp Drill, Reversible



### W6VM

Drywall Screwdriver, VSR



## W6V4

Drywall Screwdriver, VSR



### Features

- Excellent for high-speed screw applications
- Lightweight for ease of use and maneuverability
- Silent clutch lowers noise level to 76 dB
- Removable nose-piece provides easy bit replacement and adjustments
- Belt hook convenient for in between use

### Capacities

Drywall	.....#10
Wood	.....#9
Machine	.....1/4"

### Specifications

Amp	..... 6.6
Bit Shank	..... 1/4" Hex
No-Load Speed	..... 0-4,500 RPM
Max Torque	..... 81.5 in/lbs
Weight	..... 3.1 lbs

### Includes

2-9/16" Magnetic Bit Holder	..... 982554Z
No. 2 Phillips Driver Bit	..... 728336B10
Sub-Stopper (F)	..... 323351
Hook	..... 323471

### Optional

Plastic Case	..... 310904
--------------	--------------

## W6VA4

Deck/Drywall Screwdriver, VSR



### Features

- Excellent for heavy-duty applications
- Lightweight for ease of use and maneuverability
- Silent clutch lowers noise level to 76 dB
- Removable nose-piece provides easy bit replacement and adjustments
- Belt hook convenient for in between use

### Capacities

Drywall	.....#10
Wood	.....#9
Machine	.....1/4"

### Specifications

Amp	..... 6.6
Bit Shank	..... 1/4" Hex
No-Load Speed	..... 0-3,000 RPM
Max Torque	..... 112.7 in/lbs
Weight	..... 3.1 lbs

### Includes

2-9/16" Magnetic Bit Holder	..... 982554Z
No. 2 Phillips Driver Bit	..... 728336B10
Sub-Stopper (F)	..... 323351
Hook	..... 323471

### Optional

Plastic Case	..... 310904
--------------	--------------

## W6VB3

Drywall/Framing Screwdriver, VSR



### Features

- Excellent for heavy driving/high torque applications
- Lightweight for ease of use and maneuverability
- Silent clutch lowers noise level to 76 dB
- Removable nose-piece provides easy bit replacement and adjustments
- Belt hook convenient for in between use

### Capacities

Drywall	.....#10
Wood	.....#12
Machine	.....1/4"

### Specifications

Amp	..... 6.6
Bit Shank	..... 1/4" Hex
No-Load Speed	..... 0-2,600 RPM
Max Torque	..... 139.6 in/lbs
Weight	..... 3.3 lbs

### Includes

5/16" Magnetic Hex Socket	..... 985322
Sub-Stopper (B) for 5/16" Hex	..... 317671
Hook	..... 323471

### Optional

Plastic Case	..... 310904
No. 2 Phillips Driver Bit	..... 728336B10

## W8VB2

Metal to Metal Screwdriver/Nutrunner, VSR



### Features

- Excellent for repetitive metal to metal fastening applications
- Lightweight for ease of use and maneuverability
- Silent clutch lowers noise level to 76 dB
- Trigger lock-on feature for comfortable continuous use
- 25ft power cord reduces the hassle of relocating to different power outlets

### Capacities

Drywall	.....#10
Wood	.....#12
Machine	.....5/16"

### Specifications

Amp	..... 6.6
Bit Shank	..... 1/4" Hex
No-Load Speed	..... 0-1,700 RPM
Max Torque	..... 215.1 in/lbs
Weight	..... 3.3 lbs

### Includes

5/16" Magnetic Hex Socket	..... 985322
Sub-Stopper (B) for 5/16" Hex	..... 317671

### Optional

Plastic Case	..... 310904
--------------	--------------



## SuperDrive

This system has been developed for the professional subfloor, decking and drywall installer. The 20" extension handle allows the user to install screws in a standing position, reducing user fatigue and improving productivity. The **SuperDrive** system can use screws sizing from 3/4" to 3" with diameters of #6 to #12. The design of the screw driving system is simple and easy to service and, with the **SureLock** fine depth adjustment, placing screws couldn't be easier.

The **SuperDrive** system offers a wide range of screws including drywall, self drilling #2 Phillips, waxed yellow zinc subfloor, "Stabber" subfloor, 1000 hour dacro waxed decking, cement and hardboard to steel 14 – 25 gauge and cement and hardboard to wood or 20-25 gauge steel.

The **SuperDrive** system also employs a revolutionary bit system. The **LOX** bit features 12 points of contact - three times more than the four points of the Phillips and Robertson (square). Using this **LOX** system, it is not uncommon to drive as many as 25,000 screws before replacing the bit.

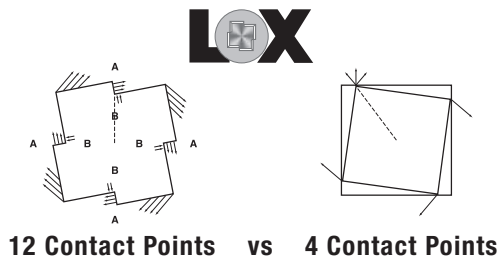

Drilling & Fastening

### Specifications

Amp	6.6
Bit Shank	1/4" Hex
No-Load Speed	0-4,500 RPM
Max Torque	81.5 in/lbs
Extension Length	20"
Weight	7.5 lbs w/ extension

### Features

- Sub floor extension allows for easy installation of collated screws
- Reliable LOX system resists jamming and prolongs bit life
- Trigger lock-on feature for comfortable continuous use
- 25ft power cord reduces the hassle of relocating to different power outlets
- Depth of drive adjustment requires the press of a block and turn of the knurled wheel to increase or decrease the depth of the screw

### Includes

SuperDrive Extension	725410
LOX & Phillips Head Bits	725439, 725438
Case-Hardened Drywall Nose Piece	725412
Canvas Padded Tool Bag	725436

### Capacities

Drywall	#10
Wood	#9
Machine	1/4"

### W6V4SD SuperDrive Collated Screw System 4,500 RPM



### Specifications

Amp	6.6
Bit Shank	1/4" Hex
No-Load Speed	0-2,600 RPM
Max Torque	139.6 in/lbs
Extension Length	20"
Weight	7.7 lbs w/ extension

### Features

- Sub floor extension allows for easy installation of collated screws
- Reliable LOX system resists jamming and prolongs bit life
- Trigger lock-on feature for comfortable continuous use
- 25ft power cord reduces the hassle of relocating to different power outlets
- Depth of drive adjustment requires the press of a block and turn of the knurled wheel to increase or decrease the depth of the screw

### Includes

SuperDrive Extension	725410
LOX & Phillips Head Bits	725439, 725438
Case-Hardened Drywall Nose Piece	725412
Canvas Padded Tool Bag	725436

### Capacities

Drywall	#10
Wood	#12
Machine	1/4"

### W6V63SD SuperDrive Collated Screw System 2,600 RPM



## SUPERDRIVE COLLATED SCREWS



P/N 17202



P/N 17212



P/N 17222



P/N 17311



P/N CCDS234G



P/N 17501



P/N 17511



P/N 17530



P/N 17605

Part No.	Description	Recess	M's Box	M's Ctn	Ctns Skid
CCDS234B	9 X 2-3/4" Comp Deck Screw, MagniGuard, Type 17 (Brown)	#2 Sq	1	4	24
CCDS234G	9 X 2-3/4" Comp Deck Screw, MagniGuard, Type 17 (Grey)	#2 Sq	1	4	24
CCDS234R	9 X 2-3/4" Comp Deck Screw, MagniGuard, Type 17 (Red)	#2 Sq	1	4	24
17202S	6 x 1-1/4" BH Dywl Strkr Pt, Phos	#2 Phil	1	4	24
17203S	6 x 1-5/8" BH Dywl Strkr Pt, Phos	#2 Phil	1	4	24
17212S	6 x 1-1/4" BH Dywl Grbr Thrd, Phos	#2 Phil	1	4	24
17213S	6 x 1-5/8" BH Dywl Grbr Thrd, Phos	#2 Phil	1	4	24
17214S	7 x 2" BH Dywl Grbr Thrd, Phos	#2 Phil	1	4	24
17218S	8 x 2-1/2" BH Dywl Grbr Thrd, Phos	#2 Phil	1	4	24
17216S	6 x 1-5/8" BH Dywl Grbr Thrd, YZ	#2 Phil	1	4	24
17222S	6 x 1-1/4" BH Self Drilling, Zinc	#2 Phil	1	4	24
17223S	6 x 1-5/8" BH Self Drilling, Zinc	#2 Phil	1	4	24
17232S	7 x 1-1/4" BH Self Drilling, Zinc	#2 Phil	1	4	24
17251S	8 x 1-3/4" Wx Yllw Zinc Subflr	#3 LOX	1	4	24
17252S	8 x 2" Wx Yllw Zinc Subflr	#3 LOX	1	4	24
17253S	8 x 2-1/2" Wx Yllw Zinc Subflr	#3 LOX	1	4	24
17254S	8 x 3" Wx Yllw Zinc Subflr	#3 LOX	1	4	24
17302S	8 x 2" Wx Yllw Zinc Subflr	#3 LOX	1	4	24
17303S	8 x 2-1/2" Wx Yllw Zinc Subflr	#2 LOX	1	4	24
17311S	8 x 1-1/2" Stabber Subflr Wax Yllw Zinc	#2 LOX	1	4	24
17312S	8 x 1-3/4" Stabber Subflr Wax Yllw Zinc	#2 LOX	1	4	24
17314S	8 x 2" Stabber Subflr Wax Yllw Zinc	#2 LOX	1	4	24
17316S	8 x 2-1/2" Stabber Subflr Wax Yllw Zinc	#2 LOX	1	4	24
17317S	8 x 3" Stabber Subflr Wax Yllw Zinc	#2 LOX	1	4	24
17407S	8 x 3" Deck 1000 Hr Magna Ct/Dacro Wx	#2 LOX	1	4	24
17423S	8 x 2" Deck 1000 Hr Magna Ct/Wx ACQ Type 17	#2 LOX	1	4	24
17425S	8 x 2-1/2" Deck 1000 Hr Magna Ct/Wx ACQ Type 17	#2 LOX	1	4	24
17427S	9 x 3" Deck 1000 Hr Magna Ct/Wx ACQ Type 17	#2 LOX	1	4	24
17431S	9 x 2-1/2" Comp Deck 1000 Hr Magna Ct/Wx ACQ (Grey)	#2 LOX	1	4	24
17432S	9 x 2-1/2" Comp Deck 1000 Hr Magna Ct/Wx ACQ (Red)	#2 LOX	1	4	24
17433S	9 x 2-1/2" Comp Deck 1000 Hr Magna Ct/Wx ACQ (Brown)	#2 LOX	1	4	24
17501S	8 x 1-1/4" Self Drllng Cement/Hardbd to 14-25ga Stl	#2 LOX	1	4	24
17502S	8 x 1-5/8" Self Drllng Cement/Hardbd to 14-25ga Stl	#2 LOX	1	4	24
17511S	8 x 1-1/4" Shp Pt Cement/Hardbd to Wd or 20-25ga Stl	#2 LOX	1	4	24
17512S	8 x 1-5/8" Shp Pt Cement/Hardbd to Wd or 20-25ga Stl	#2 LOX	1	4	24
17530S	10 x 3/4" Stl Framing, Self Drllng 14-20 Stl, YZ	#2 LOX	1	4	24
17605	8 x 2-1/2" Deck BH 316 Stainless Steel 8 TPI, Type 17	#2 LOX	1	1	24
17625	10 x 2-1/2" Deck BH 316 Stainless Steel 8 TPI, Type 17	#2 LOX	1	1	24
17627	10 x 3" Deck BH 316 Stainless Steel 8 TPI, Type 17	#2 LOX	1	1	24
17630	9 x 2-1/2" Deck, Sharp Pt, 302 Stainless Steel 8 TPI	#2 LOX	1	1	24

## SUB STOPPERS NOSE PIECES AND EXTENSIONS

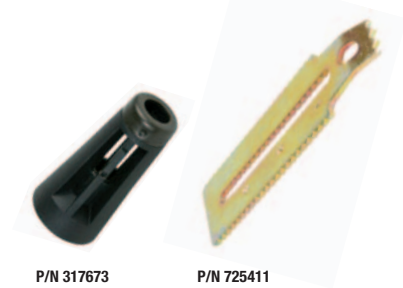

P/N 317673

P/N 725411

Part No.	Description	Use with Bit Holder
317673	1/4" Sub Stopper (C)	982554Z
317671	5/16" Sub Stopper (B)	985322
323352	1/4" Sub Stopper (G)	317674
323351	1/4" Sub Stopper (F)	982554Z
317670	3/8" Sub Stopper (B)	985330
725476	19" Extension Bar	
725479	Complete Sub Floor 75 Extension	
725411	Nosepiece for Subfloor and Metal to Metal	
725412	Nosepiece for Deck and Drywall	
725414	Indexing Module with Feed Track and Bracket	
725417	Indexing Module with Feed Track	

## DRIVER BITS



P/N 725439

PHILLIPS

P/N 725438

Part No.	Size	Length	Type	Model
725450	#2 LOX	1"	Insert Tip	
725451	#2 LOX	1-1/2"	Insert Tip	
725452	#2 LOX	2"	Insert Tip	
725453	#2 LOX	2-1/2"	Power Bit	
725454	#2 LOX	3"	Power Bit	
725455	#2 LOX	3-1/2"	Power Bit	
725456	#2 LOX	4-1/2"	Power Bit	
725457	#2 LOX	4-3/4"	PAM to LOX	SS2K
725441	#2 LOX	5"	Senco to LOX	DS200-AC/ -D2/ -14V
725442	#2 LOX	5-1/2"	PAM to LOX	P13L/ P13KUE/ P13KDE
725459	#2 LOX	6-1/4"	Senco to LOX	DS300-AC/ DS205-14V/ DS202-14V
725439	#2 LOX	7"	SuperDrive	
725447	#2 LOX	8"	Senco to LOX	DS200-S2/ DS200-S4
725440	#2 LOX	9"	Senco to LOX	DS300-S2 / -S4/ -D2
725458	#3 LOX	4-3/4"	PAM to LOX	SS2K
725445	#3 LOX	5"	Senco to LOX	DS200-AC/ -D2/ -14V
725446	#3 LOX	5-1/2"	PAM to LOX	P13L/ P13KUE/ P13KDE
725460	#3 LOX	6-1/4"	Senco to LOX	DS300-AC/ DS205-14V/ DS202-14V
725443	#3 LOX	7"	SuperDrive	
725448	#3 LOX	8"	Senco to LOX	DS200-S2/ DS200-S4
725444	#3 LOX	9"	Senco to LOX	DS300-S2/ -S4/ -D2
725438	#2 Phillips	7"	SuperDrive	
725449	#2 Square	7"	SuperDrive	
725462	#2 Phillips	5-1/8"		
725463	#2 LOX	5-1/8"		
725464	#3LOX	5-1/8"		

## MISCELLANEOUS SUPERDRIVE ACCESSORIES



P/N 725498

P/N 725434

P/N 725436

Part No.	Description
305690	Rubber Ring
323471	Hook
725434	Tri-Flow Oil (2.0 Oz)
725436	Canvas Padded Tool Bag
725498	Hitachi Cordless Impact Driver to SuperDrive Coupler

## WR16SA

1/2" Square Drive Impact Wrench



### Features

- Class leading torque to handle stubborn fasteners
- Industrial pin-detent socket retainer keeps socket firmly attached
- Forward-reverse rocker switch to quickly change fastening direction
- Large bumper protects the tools gear cover
- Compact and lightweight for greater ease of use and maneuverability

### Capacities

Bolt . . . . . M12 - M22 (1/2" - 7/8")  
 High Tension Bolt . . . . . M12 - M16 (1/2" - 5/8")

### Specifications

Amp . . . . . 4.2  
 Drive . . . . . 1/2" Square  
 No Load Speed . . . . . 1,900 RPM  
 Impact Rate . . . . . 2,100 IPM  
 Max Torque . . . . . 270 ft/lbs  
 Weight . . . . . 6.2 lbs

### Includes

1/2" Square to Hex Adapter . . . . . 728589  
 Side Handle Assembly . . . . . 323774  
 Extension Bar Assembly . . . . . 873633  
 Plastic Case . . . . . 323777

## WR22SA

3/4" Square Drive Impact Wrench



### Features

- Internal Double Insulation (IDI) technology doubles tool life
- Class leading torque to handle stubborn fasteners
- Most compact and lightweight wrench in its class for greater ease of use
- Large heat-resistant bumper protects the tool, work piece and the user
- Industrial pin-detent socket retainer keeps socket firmly attached
- Forward-reverse rocker switch to quickly change fastening direction

### Capacities

Bolt . . . . . M14 - M24 (9/16" - 15/16")  
 High Tension Bolt . . . . . M16 - M22 (5/8" - 7/8")

### Specifications

Amp . . . . . 7.5  
 Drive . . . . . 3/4" Square  
 No Load Speed . . . . . 1,800 RPM  
 Impact Rate . . . . . 2,000 IPM  
 Max Torque . . . . . 450 ft/lbs  
 Weight . . . . . 10.6 lbs

### Includes

Side Handle . . . . . 324015  
 Plastic Case . . . . . 324014

### Optional

Extension Bar Assembly . . . . . 874535  
 Universal Joint Assembly . . . . . 955088

Drilling & Fastening

## HAMMER DRILL / ROTARY HAMMER QUICK REFERENCE

Model	Shank	Benefit	Variable Speed	Reversible	Clutch	Weight	Impact Energy (ft.-lbs)	Drilling Only	Hammer Drilling	Hammer Only	Capacity				Page
											Wood	Steel	Concrete		
													Solid Bit	Core Bit	
FDV16VB2	Straight		Y	Y	N	3.5	n/a	●	●	-	1"	1/2"	5/8"	n/a	34
DV16V	Straight		Y	Y	N	3.7	n/a	●	●	-	1"	1/2"	5/8"	n/a	34
DV16VSS	Straight		Y	Y	N	3.3	n/a	●	●	-	1"	1/2"	5/8"	n/a	34
DV20VB2	Straight		Y	Y	N	4.9	n/a	●	●	-	1-9/16"	1/2"	3/4"	n/a	34
DH18DL	SDS Plus	<i>Mithium-ion</i>	Y	Y	Y	5.1	1.0	●	●	-	3/4"	1/2"	5/8"	n/a	10
DH22PG	SDS Plus		Y	Y	Y	4.2	1.0	●	●	-	1"	1/2"	7/8"	n/a	35
DH24PB3	SDS Plus		Y	Y	Y	5.0	2.5	●	●	-	1-1/4"	1/2"	15/16"	2"	35
DH24PC3	SDS Plus		Y	Y	Y	5.3	2.5	●	●	●	1-1/4"	1/2"	15/16"	2"	35
DH24PF3	SDS Plus		Y	Y	Y	5.3	2.5	●	●	●	1-1/4"	1/2"	15/16"	2"	35
DH25PB	SDS Plus		Y	N	Y	7.5	2.2	●	●	-	1-1/4"	1/2"	1"	3-1/2"	35
DH25DAL	SDS Plus	<i>Mithium-ion</i>	Y	Y	Y	7.9	2.1	●	●	●	1-3/16"	1/2"	1"	n/a	10
DH28PC	SDS Plus		Y	Y	Y	7.7	3.5	●	●	●	1-1/4"	1/2"	1-1/8"	n/a	36
DH28PD	SDS Plus	DUST EXTRACTION	Y	Y	Y	7.7	3.5	●	●	●	1-1/4"	1/2"	1-1/8"	n/a	36
DH30PC2	SDS Plus		Y	N	Y	9.5	4.0	●	●	●	1-1/4"	1/2"	1-3/16"	3-17/32"	36
DH38YE	Spline		N	N	Y	17.0	5.2	-	●	●	n/a	n/a	1-1/2"	4-1/8"	37
DH38YE2	Spline		N	N	Y	14.1	5.9	-	●	●	n/a	n/a	1-1/2"	4-1/8"	37
DH40FR	Spline	<i>HDI INTERNAL DOUBLE INSULATION</i>	Y	N	Y	14.3	7.4	-	●	●	n/a	n/a	1-9/16"	4-1/8"	37
DH50SBK	Spline		N	N	Y	19.2	9.6	-	●	●	n/a	n/a	2"	5"	37
DH38MS	SDS Max		N	N	Y	14.1	6.6	-	●	●	n/a	n/a	1-1/2"	4-1/8"	38
DH40MRY	SDS Max	<i>UVP</i>	Y	N	Y	15.0	7.7	-	●	●	n/a	n/a	1-9/16"	4-1/8"	38
DH45MR	SDS Max	<i>HDI INTERNAL DOUBLE INSULATION</i>	Y	N	Y	17.6	11.4	-	●	●	n/a	n/a	1-3/4"	4-29/32"	38
DH50MRY	SDS Max	<i>UVP</i>	Y	N	Y	23.1	14.7	-	●	●	n/a	n/a	2"	6-1/4"	38

Concrete & Masonry

## DEMO HAMMER QUICK REFERENCE

Model	Shank	Benefit	Variable Speed	Trigger Lock	Weight	Impact Energy (ft.-lbs)	Page
H45FRV	3/4 Hex/Rd	<i>HDI INTERNAL DOUBLE INSULATION</i>	Y	Y	13.0	9.2	39
H45MRY	SDS Max	<i>UVP</i>	N	Y	13.0	9.4	39
H55SCK	3/4 Hex		N	N	24.3	11.8	39
H60MRV	SDS Max	<i>HDI INTERNAL DOUBLE INSULATION</i>	Y	Y	23.1	19.2	39
H65SD2	1-1/8 Hex	<i>HDI INTERNAL DOUBLE INSULATION</i>	N	Y	40.8	31.0	40
H90SE	1-1/8 Hex		N	N	70.5	40.6	40

## FDV16VB2

5/8" 5-Amp Hammer Drill,  
2 Mode, VSR



### Features

- Variable speed control dial located on trigger for ease of use
- Push button reversible drilling for quick removal of bits
- Non-slip grip comfortably fits in hand for improved control
- Industrial grade keyed chuck provides greater bit retention
- Low noise cool air flow design prevents overload for longer use

### Capacities

Concrete	5/8"
Wood	1"
Steel	1/2"

### Specifications

Amp	5
Chuck	1/2" Keyed 3-Jaw
No-Load Speed	0-2,900 RPM
Impact Rate	0-46,400 BPM
Shank	Straight
Length	11-3/8"
Weight	3.5 lbs

### Includes

Side Handle	303659
Depth Stopper	303709
Chuck Key	303334
Case	315999

## DV16VSS

5/8" 5.4-Amp Hammer Drill,  
2 Mode, VSR



### Features

- 5.4 Amp Motor capable of reaching 2,900 RPM (best-in-class)
- Innovative sleeve construction for rugged durability
- Ratchet with cooling steel fin increases heat resistance and strength
- Variable speed allows the user to determine the right amount of power when needed
- Most compact in its class to fit into tight spaces
- Lightest weight in its class for less fatigue and more control

### Capacities

Concrete	5/8"
Wood	1"
Steel	1/2"

### Specifications

Amp	5.4
Chuck	1/2" Keyed 3-Jaw
No-Load Speed	0-2,900 RPM
Impact Rate	0-46,400 BPM
Shank	Straight
Length	10-19/32"
Weight	3.3 lbs

### Includes

Side Handle	303659
Depth Stopper	303709
Case	315999

## DV16V

5/8" 6-Amp Hammer Drill,  
2 Mode, VSR



### Features

- Variable speed control dial located on trigger for ease of use
- Push button reversible drilling for quick removal of bits
- Non-slip grip comfortably fits in hand for improved control
- One piece housing and aluminum inner & gear cover add durability
- Industrial grade keyed chuck provides greater bit retention
- Short center height fits easily into narrow work spaces

### Capacities

Concrete	5/8"
Wood	1"
Steel	1/2"

### Specifications

Amp	6
Chuck	1/2" Keyed 3-Jaw
No-Load Speed	0-2,900 RPM
Impact Rate	0-46,400 BPM
Shank	Straight
Length	10-19/32"
Weight	3.7 lbs

### Includes

Side Handle	303659
Depth Stopper	303709
Chuck Key	303334
Case	315999

## DV20VB2

3/4" 8.3-Amp Hammer Drill,  
2 Mode, VSR



### Features

- One of the most compact and lightweight drills in its class
- Best in class drilling speed
- One of the quietest hammer drills on the market (no-load noise level 79dB)
- Powerful 940 Watt motor makes quick work of heavy-duty jobs
- Push button reversible drilling for quick removal of bits

### Capacities

Concrete	3/4"
Wood	1-9/16"
Steel	1/2"

### Specifications

Amp	8.3
Chuck	1/2" Keyed 3-Jaw
No-Load Speed	0-1,000/3,000 RPM
Impact Rate	0-13,000/39,000 BPM
Shank	Straight
Length	13-1/8"
Weight	4.9 lbs

### Includes

Side Handle	323050
Depth Stopper	303709
Chuck Key	987576
Case	322706

Concrete & Masonry

### Specifications

Amp	5.4
Shank	SDS Plus
Impact Energy	1.0 ft/lbs
No-Load Speed	0-1,500 RPM
Impact Rate	0-6,200 BPM
Length	11-3/8"
Weight	4.2 lbs

### Includes

Case	327883
Depth Gauge	310331
Side Handle	324548

### Specifications

Amp	7.0
Shank	SDS Plus
Impact Energy	2.5 ft/lbs
No-Load Speed	0-1,050 RPM
Impact Rate	0-4,600 BPM
Length	13.81"
Weight	5.0 lbs

### Includes

Case	324548
Depth Gauge	310331
Side Handle	324555

### Optional

3-Jaw Chuck (Hammer Only)	303332
3-Jaw Chuck (Drilling Only)	303820
SDS+ to 1/2" Square Male	303044
Service Kit	326305

### Specifications

Amp	7.0
Shank	SDS Plus
Impact Energy	2.5 ft/lbs
No-Load Speed	0-1,150 RPM
Impact Rate	0-4,600 BPM
Length (DH24PF3)	15.94"
Length (DH24PC3)	13.81"
Weight	5.3 lbs

### Includes

Case (DH24PF3)	324591
Case (DH24PC3)	324555
Depth Gauge	310331
Side Handle	324548

### Optional

3-Jaw Chuck (Hammer Only)	303332
3-Jaw Chuck (Drilling Only)	303820
SDS+ to 1/2" Square Male	303044
Service Kit	326305

### Specifications

Amp	5.7
Shank	SDS Plus
Impact Energy	2.2 ft/lbs
No-Load Speed	0-1,100 RPM
Impact Rate	0-4,000 BPM
Length	12-1/2"
Weight	7.5 lbs

### Includes

Case	318307
Depth Gauge	980906
Side Handle	980939
Dust Cup	971787

### Features

- Hitachi's lightest and most compact SDS hammer for greater ease of use in tight or overhead applications
- Quick bit insert for easy accessory changes
- Idle strike restrictor prevents no-load hammering to prolong tool life and reduce no-load vibration
- Slip clutch prevents gear damage and increases user safety

### Capacities

Concrete	7/8"
Wood	1"
Steel	1/2"

### Features

- Best-in-class impact energy delivering high-speed drilling and forcible chipping
- One of the most compact and lightweight rotary hammers in its class
- Mode selector dial to quickly transition between hammer/drill & drill-only modes
- Quick bit insert for easy accessory changes
- Lock-on speed button for continuous operation to reduce user fatigue

### Capacities

Concrete	15/16"
Wood	1-1/4"
Steel	1/2"

### Features

- Best-in-class impact energy delivering high-speed drilling and forcible hammering
- One of the most compact and lightweight rotary hammers in its class
- Mode selector dial to quickly transition between drill-only, hammer only and hammer/drill modes
- Quick bit insert for easy accessory changes
- Lock-on speed button for continuous operation to reduce user fatigue

### Capacities

Concrete	15/16"
Wood	1-1/4"
Steel	1/2"

### Features

- Lightweight and compact for greater ease of use and maneuverability
- Advanced cooling design lengthens run time and prevents tool damage
- Powerful motor provides drill-only or hammer/drill modes
- Electronic variable speed switch delivers speed while minimizing changes in rotation and hammering
- Dust control design reduces wear and tear on tool from airborne debris

### Capacities

Concrete/Drill Bit	1"
Concrete/Core Bit	3-1/2"
Wood	1-1/4"
Steel	1/2"

## DH22PG

7/8" SDS Plus Rotary Hammer,  
2 Mode, VSR



## DH24PB3

15/16" SDS Plus Rotary Hammer,  
2 Mode, VSR



## DH24PF3 - DH24PC3

15/16" SDS Plus Rotary Hammer,  
3 Mode, VSR



DH24PC3  
Pistol Grip



## DH25PB

31/32" SDS Plus Rotary Hammer,  
2 Mode, EVS



## DH28PC

1-1/8" SDS Plus Rotary Hammer, 3 Mode, EVS



### Features

- Lightest and most compact rotary hammer in its class
- Best in class impact energy delivers fast drilling and chiseling speeds
- Mode selector dial controls drill-only, hammer-only or hammer/drill modes
- 36-position variable lock mechanism allows for simple adjustment of chisels to the most comfortable working angle

### Specifications

Amp	6.9
Shank	SDS Plus
Impact Energy	3.5 ft/lbs
No-Load Speed	0-800 RPM
Impact Rate	0-4,000 BPM
Length	12-7/16"
Weight	7.7 lbs

### Capacities

Concrete	1-1/8"
Wood	1-1/4"
Steel	1/2"

### Includes

Case	330220
Side Handle	330208
Depth Stopper	982671

## DH28PD

1-1/8" SDS Plus Rotary Hammer, 3 Mode, EVS with Dust Collection



### Features

- Highest dust collection performance in its class
- Lightest and most compact rotary hammer in its class
- Best in class impact energy delivers fast drilling and chiseling speeds
- Mode selector dial controls drill-only, hammer-only or hammer/drill modes
- 36-position variable lock mechanism allows for simple adjustment of chisels to the most comfortable working angle

### Specifications

Amp	6.9
Shank	SDS Plus
Impact Energy	3.5 ft/lbs
No-Load Speed	0-800 RPM
Impact Rate	0-4,000 BPM
Length	12-7/16"
Weight	7.7 lbs

### Capacities

Concrete	1-1/8"
Wood	1-1/4"
Steel	1/2"

### Includes

Case	330220
Depth Gauge	982671
Side Handle	330208
Cover	331730
Rubber Cap	331731

## DUST EXTRACTION

The new dust collection system available on the DH28PD is a marked improvement over previous systems which use the air flow created by the rotating bit to blow any dust not carried by the flutes of the bit out of the hole.

The new DH28PD uses the suction of the dust collection fan to draw dust from the hole being drilled, resulting in a higher rate of dust collection. A cleaner hole makes placement of anchors and adhesives quicker and more reliable.

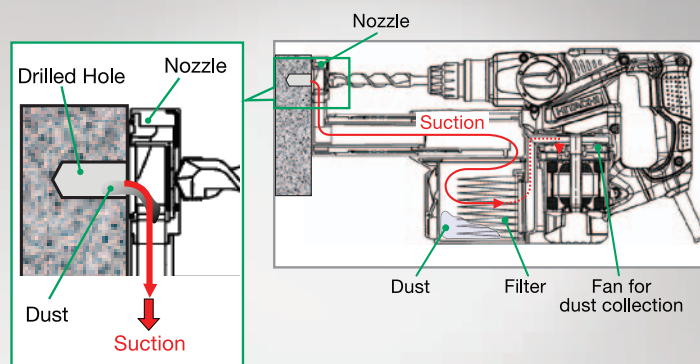

## DH30PC2

1-3/16" SDS Plus Rotary Hammer, 3 Mode, EVS



### Features

- Lightest and most compact rotary hammer in its class
- Best in class impact energy delivers fast drilling and chiseling speeds
- Mode selector dial controls drill-only, hammer-only or hammer/drill modes
- 36-position variable lock mechanism allows for simple adjustment of chisels to the most comfortable working angle

### Specifications

Amp	7.4
Shank	SDS Plus
Impact Energy	4.0 ft/lbs
No-Load Speed	0-850 RPM
Impact Rate	0-3,700 BPM
Length	14"
Weight	9.5 lbs

### Capacities

Concrete	1-3/16"
Wood	1-1/4"
Steel	1/2"

### Includes

Case	325679
Depth Gauge	320973
Side Handle	313078
Blow Bulb Syringe	318085

Concrete & Masonry



### Specifications

Amp	8.0
Shank	Spline
Impact Energy	5.2 ft/lbs
No-Load Speed	380 RPM
Impact Rate	2,800 BPM
Length	17-15/16"
Weight	17.0 lbs

### Includes

Case	317657
Depth Gauge	971786
Side Handle	981870
Dust Cover	985373
5mm Hex Wrench	944459
1oz Tube of Hammer Grease	981840

### Optional

Service Kit	985491
-------------	--------

### Features

- Delivers high-speed drilling and forcible chipping
- Operates in hammer-only or hammer/drill modes for flexibility
- Sealed grease system ensures minimal maintenance
- Dust proof cover protects tool for extended maintenance free operation
- Removable side handle with depth gauge improves control and accuracy

### Capacities

Core Bit	4-1/8"
Drill Bit	1-1/2"

### DH38YE

1-1/2" Spline Shank Rotary Hammer, 2 Mode



### Specifications

Amp	8.4
Shank	Spline
Impact Energy	5.9 ft/lbs
No-Load Speed	510 RPM
Impact Rate	2,800 BPM
Length	16-11/32"
Weight	14.1 lbs

### Includes

Case	331965
Side Handle	330209
Dust Cover	993245
Depth Stopper	971786

### Features

- Delivers high-speed drilling and forcible chipping in a more ergonomic, lightweight tool body that produces less noise and vibration
- Mode selector dial controls hammer-only or hammer/drill modes
- Sealed grease system ensures minimal maintenance
- Dust proof cover protects tool for extended maintenance free operation
- Safety clutch improves user protection in the event of a bound bit

### Capacities

Core Bit	4-1/8"
Drill Bit	1-1/2"

### DH38YE2

1-1/2" Spline Shank Rotary Hammer, 2 Mode



### Specifications

Amp	9.2
Shank	Spline
Impact Energy	7.4 ft/lbs
No-Load Speed	240-480 RPM
Impact Rate	1,320-2,650 BPM
Length	16-15/16"
Weight	14.3 lbs

### Includes

Case	322152
Depth Gauge	971786
Side Handle	313078
Hex Wrenches	944458, 943277, 944459
1oz Tube of Hammer Grease	981840
Dust Cover	993245

### Features

- IDI (Internal Double Insulation) Technology prolongs tool life by providing a durable metal housing, reducing vibration and extending brush life, while realizing double insulation characteristics of plastic housing tools
- Operates in hammer-only or hammer/drill modes for flexibility
- Built-in electronic control circuit keeps speed constant even as load varies
- Slip clutch stops rotation in the event of a bound bit for added safety
- Removable side handle with depth gauge improves control and accuracy

### Capacities

Core Bit	4-1/8"
Drill Bit	1-9/16"

### DH40FR

1-9/16" Spline Shank Rotary Hammer, 2 Mode, EVS



### Specifications

Amp	10.4
Shank	Spline
Impact Energy	9.6 ft/lbs
No-Load Speed	300 RPM
Impact Rate	2,450 BPM
Length	19-3/4"
Weight	19.2 lbs

### Includes

Steel Case	C102405H
D-Type Side Handle	986959
Bar-Type Side Handle	956259
Dust Cover	993245
6mm Hex Wrench	872422
1oz Tube of Hammer Grease	981840

### Features

- Delivers high-speed drilling and forcible chipping
- Operates in hammer-only or hammer/drill modes for flexibility
- "Mouth-less idle" hammering mechanism prevents no-load hammering and reduces wear and tear on the tool
- Sealed grease system ensures minimal maintenance
- Replaceable auto-stop carbon brush system to prolong tool life and protect the armature

### Capacities

Core Bit	5"
Drill Bit	2"

### DH50SBK

2" Spline Shank Rotary Hammer, 2 Mode



## DH38MS

1-1/2" SDS Max Rotary Hammer, 2 Mode



### Features

- Powerful 8.4 Amp, 950 Watt motor provides 6.6 ft-lbs of impact energy
- 2-modes of operation - Allows for greater versatility by providing the option of hammer drilling or hammer only
- Safety clutch for improved user protection in bound bit situations
- Sealed grease system for extended maintenance free operation

### Capacities

Core Bit	4-1/8"
Drill Bit	1-1/2"

### Specifications

Amp	8.4
Shank	SDS Max
Impact Energy	6.6 ft/lbs
No-Load Speed	510 RPM
Impact Rate	2,800 BPM
Full Load Tri-Axial Vibration	16.1m/s <sup>2</sup>
Length	17-1/16"
Weight	14.1 lbs

### Includes

Case	331206
Side Handle	330209

## DH40MRY

1-9/16" SDS Max Low Vibration Rotary Hammer, 2 Mode, EVS



### Features

- Patented User Vibration Protection (UVP) Technology for 56% less full-load tri-axial vibration to significantly reduce vibration transfer to the user
- Operates in hammer-only or hammer/drill modes for flexibility
- Delivers faster drilling and best-in-class material removal
- Optimized striking for more efficient transmission of power
- Constant speed control for steady performance even under a variable load
- Variable lock mechanism for simple adjustment of chisels to various angles

### Capacities

Core Bit	4-1/8"
Drill Bit	1-9/16"

### Specifications

Amp	9.2
Shank	SDS Max
Impact Energy	7.7 ft/lbs
No-Load Speed	240 - 480 RPM
Impact Rate	1,320 - 2,650 BPM
Full Load Tri-Axial Vibration	8.3m/s <sup>2</sup>
Length	18.9"
Weight	15.0 lbs

### Includes

Case	326489
Depth Gauge	971786
Side Handle	313078
1oz Tube of Hammer Grease	981840

## DH45MR

1-3/4" SDS Max Rotary Hammer, 2 Mode, EVS



### Features

- IDI (Internal Double Insulation) Technology prolongs tool life by providing a durable metal housing, reducing vibration and extending brush life, while realizing double insulation characteristics of plastic housing tools
- Best-in-Class impact energy for unmatched performance
- Operates in hammer-only or hammer/drill modes for flexibility
- Constant speed control for steady performance even under a variable load
- Variable lock mechanism for simple adjustment of chisels to various angles

### Capacities

Core Bit	4-29/32"
Drill Bit	1-3/4"

### Specifications

Amp	11.6
Shank	SDS Max
Impact Energy	11.4 ft/lbs
No-Load Speed	120 - 240 RPM
Impact Rate	1,200 - 2,500 BPM
Length	19.7"
Weight	17.6 lbs

### Includes

Case	324820
Depth Gauge	971786
Side Handle	313078
Hex Bar Wrenches	944458, 944459
1oz Tube of Hammer Grease	981840

## DH50MRY

2" SDS Max Low Vibration Rotary Hammer, 2 Mode, EVS



### Features

- Patented User Vibration Protection (UVP) Technology combines a counter balance with handle dampers to reduce full load vibration by up to 55%
- Two modes of operation for flexibility
- Constant speed control for steady performance even under a variable load
- Variable lock mechanism for simple adjustment of chisels to various angles
- Idle strike restrictor prevents no-load hammering, extending tool life
- Slip clutch stops rotation in the event of a bound bit for added safety

### Capacities

Core Bit	6-1/4"
Drill Bit	2"

### Specifications

Amp	12.8
Shank	SDS Max
Impact Energy	14.7 ft/lbs
No-Load Speed	110 - 230 RPM
Impact Rate	1,050 - 2,150 BPM
Full Load Tri-Axial Vibration	11.7 m/s <sup>2</sup>
Length	22-7/16"
Weight	23.1 lbs

### Includes

Case	329317
Depth Gauge	303709
Side Handle	323155
1oz Tube of Hammer Grease	981840

### Specifications

Amp	8.3
Shank	3/4" Hex/Round
Impact Energy	9.2 ft/lbs
Impact Rate	0 – 3,000 BPM
Length	16-13/16"
Weight	13.0 lbs

### Includes

Case	323370
Side Handle	317103
Hex Bar Wrenches	944458, 944459

### Optional

Dust Cover	993245
------------	--------

### Features

- IDI (Internal Double Insulation) Technology prolongs tool life by providing a durable metal housing, reducing vibration and extending brush life, while realizing double insulation characteristics of plastic housing tools
- Highest impact energy in its class for 40% more chipping power
- Switch handle with vibration isolators reduces user fatigue
- Removable side D-handle improves control and reduces vibration

**H45FRV**  
3/4" Round/Hex Demolition Hammer, EVS



### Specifications

Amp	9.2
Shank	SDS Max
Impact Energy	9.4 ft/lbs
Impact Rate	3,000 BPM
Full Load Tri-Axial Vibration	7.7 m/s <sup>2</sup>
Length	18.7"
Weight	13.0 lbs

### Includes

Case	326511
Side Handle	317103
12" Bull Point	724963

### Features

- Patented User Vibration Protection (UVP) Technology for 60% less full-load tri-axial vibration to significantly reduce vibration transfer to the user
- Best-in-class impact energy for 16% faster chiseling and best-in-class material removal rates
- Variable lock mechanism for simple adjustment of chisels to multiple angles
- Idle strike restrictor prevents no-load activation and additional wear on the tool
- Lock-on button built into trigger for comfort during extended use

**H45MRY**  
SDS Max Low Vibration Demolition Hammer



### Specifications

Amp	10.4
Shank	3/4" Hex
Impact Energy	11.8 ft/lbs
Impact Rate	1,450 BPM
Length	22-1/4"
Weight	24.3 lbs

### Includes

Steel Case	C102405H
Side Handle	986959
6mm Hex Wrench	872422
Dust Cover	985468
12" Bull Point	985430

### Features

- Delivers forcible chipping with low vibration and low noise level
- "Mouth-less idle" hammering mechanism prevents no-load hammering and reduces wear and tear on the tool
- Dust proof cover protects tool for extended maintenance free operation
- Removable side D-handle improves control and reduces vibration
- Variable lock system makes bit replacement simple and offers multiple tool angles for chiseling

**H55SCK**  
3/4" Hex Demolition Hammer



Also Available:  
H55SC - Without Case

### Optional

Service Kit	986966
-------------	--------

### Specifications

Amp	12.5
Shank	SDS Max
Impact Energy	19.2 ft/lbs
Impact Rate	930 – 1,650 BPM
Length	22-43/64"
Weight	23.1 lbs

### Includes

Case	324049
Side Handle	317103
Bull Point	724963
6mm Hex Wrench	872422

### Features

- IDI (Internal Double Insulation) Technology prolongs tool life by providing a durable metal housing, reducing vibration and extending brush life, while realizing double insulation characteristics of plastic housing tools
- Low operating noise (only 91.5 dB with full-load) making it one of the quietest demolition hammers on the market
- Constant speed control maintains impact rate even as load varies
- Vibration absorbing handle reduces user fatigue
- Variable lock mechanism for simple adjustment of chisels to multiple angles

**H60MRV**  
SDS Max Demolition Hammer, EVS



Concrete & Masonry

## H65SD2

1-1/8" Hex 40 lb Demolition Hammer



**IDI** INTERNAL DOUBLE INSULATION



### Features

- IDI (Internal Double Insulation) Technology prolongs tool life by providing a durable metal housing, reducing vibration and extending brush life, while realizing double insulation characteristics of plastic housing tools
- Best in class impact energy- 50% more than competitive hammers in the category
- Universal tool retainer accepts 3 types of 1-1/8" hex shank bits; standard hex, collarless retaining groove and air tool bits
- Lock-on trigger for comfortable extended use
- Low noise level and low vibration levels for less fatigue with continuous use

### Specifications

Amp	10.8
Shank	1-1/8" Hex
Impact Energy	31.0 ft/lbs
Impact Rate	1,400 BPM
Length	32-13/32"
Weight	40.8 lbs

### Includes

Plastic Rolling Case	333356
3mm Hex Bar Wrench	943277
6mm Hex Bar Wrench	872422

## H90SE - H90SEKIT4

1-1/8" Hex 70 lbs Breaker



**H90SEKIT4**



### Features

- Designed for heavy-duty demolition
- Shock mounted handles absorb vibration and reduce user fatigue
- Improved hammering mechanism delivers more energy to the bit tip, increasing demolition performance
- Universal tool retainer accepts 3-types of 1-1/8" hex shank bits; standard hex, collarless retaining groove and air tool bits
- Sealed grease lubrication for minimal maintenance and maximum durability

### Specifications

Amp	13.3
Shank	1-1/8" Hex
Bit Types	Collared or Slotted
Impact Energy	40.6 ft/lbs
Impact Rate	850 BPM
Length	33-13/16"
Weight	70.5 lbs

### Includes

3mm Hex Bar Wrench	943277
5mm Hex Bar Wrench	944459
10mm Hex Bar Wrench	993740

### Also Available

H90SEKIT4 . . . . . Includes Cart & 4-Pieces of Steel

# CARRYING CASES & CARTS



Plastic Case



P/N 333356



P/N 207010

Part No.	Applicable Tool	Type
207010	H65, H85, H90SB	Cart
207011	H65SD2, H90SE	Cart
315999	FDV16VB2	Plastic Case
321635	DV16V	Plastic Case
322706	DV20VB2	Plastic Case
327883	DH22PG	Plastic Case
324555	DH24PB3, DH24PC3	Plastic Case
324591	DH24PF3	Plastic Case
318307	DH25PB	Plastic Case
325679	DH30PC2	Plastic Case
317657	DH38YE	Plastic Case
322152	DH40FR	Plastic Case
C102405H	DH50SB, H55SC	Steel Case
326489	DH40MRY	Plastic Case
324820	DH45MR	Plastic Case
329317	DH50MRY	Plastic Case
323370	H45FRV	Plastic Case
326511	H45MRY	Plastic Case
324049	H60MRV	Plastic Case
333356	H65SD2	Plastic Case

### Specifications

Amp	11.6
Max Wheel Diameter	4-3/8"
Arbor	20mm & 7/8"
No-Load Speed	11,500 RPM
Max Cutting Depth	1-3/8"
Length	8-1/8"
Weight	6.2 lbs

### Includes

4" Continuous Rim Blade	728726
Wrench	941057
10mm Box Wrench	940543
20mm Flange	956879

### Specifications

Amp	8
Max Wheel Diameter	5"
No-Load Speed	10,000 RPM
Spindle	5/8 x 11
Max Cutting Depth	1-3/16"
Length	12-3/8"
Weight	6.4 lbs

### Includes

Case	328845
Wheel Guard Assembly	328740
Vacuum Adapter	320994
Side Handle	994322
Spanner Wrench	937913Z

### Features

- Sealed armature coil is protected from dust and debris- ideal for dry cutting applications
- Sealed armature coil additionally helps to minimize vibration
- Short base edge-to-blade distance for easy cuts in tight spaces
- One touch lever adjusts the depth of cut quickly and easily
- Compact and lightweight for less fatigue and easy maneuverability

### Features

- Powerful motor for fast material removal and high overload durability during tough cutting applications
- Efficient dust collection removes 95% of dust with vacuum attachment for cleaner, safer and more comfortable operation
- Tool-less depth adjustment for quickly increasing depths on multiple passes
- Trigger lock-on for easy continuous operation
- Spindle lock for quick and easy accessory changes

### CM4SB2

4" Dry-Cut Masonry Saw



### CM5SB

5" Concrete / Masonry Cutter



Concrete & Masonry

## MITER SAW QUICK REFERENCE

Model	Type	Blade Diameter	RPMs	Range		Capacity			Page
				Miter	Bevel	Cross Cut (90°)	Miter (45°)	Compound (Miter 45° / Bevel 45°)	
C8FSE	Slide Compound	8-1/2"	5,500	L 0° - 45° R 0° - 57°	L 0° - 48° R 0° - 5°	2-9/16" x 12"	2-9/16" x 8-21/32"	1-25/32" x 8-21/32"	44
C8FSHE	Slide Compound with Laser Marker and LED Light	8-1/2"	5,500	L 0° - 45° R 0° - 57°	L 0° - 48° R 0° - 5°	2-9/16" x 12"	2-9/16" x 8-21/32"	1-25/32" x 8-21/32"	44
C10FCE2	Compound	10"	5,000	L 0° - 52° R 0° - 52°	L 0° - 45°	2-5/16" x 5-21/32" or 3-1/2" x 3-31/32"	2-5/16" x 4"	1-5/8" x 4"	45
C10FCH2	Compound with Laser Marker	10"	5,000	L 0° - 52° R 0° - 52°	L 0° - 45°	2-5/16" x 5-21/32" or 3-1/2" x 3-31/32"	2-5/16" x 4"	1-5/8" x 4"	45
C10FSB	Slide Dual Compound	10"	3,800	L 0° - 45° R 0° - 57°	L 0° - 45° R 0° - 45°	3-11/32" x 12-9/32"	3-11/32" x 8-19/32"	2-3/16" x 8-19/32"	45
C10FSH	Slide Dual Compound with Laser Marker	10"	3,800	L 0° - 45° R 0° - 57°	L 0° - 45° R 0° - 45°	3-11/32" x 12-9/32"	3-11/32" x 8-19/32"	2-3/16" x 8-19/32"	45
C12LCH	Compound with LCD Display and Laser Marker	12"	4,000	L 0° - 52° R 0° - 52°	L 0° - 48° R 0° - 3°	2-1/2" x 7-7/8" or 3-7/8" x 6-1/8"	2-1/2" x 5-1/2"	1-5/8" x 5-1/2"	46
C12FCH	Compound with Laser Marker	12"	4,000	L 0° - 52° R 0° - 52°	L 0° - 48° R 0° - 3°	2-1/2" x 7-7/8" or 3-7/8" x 6-1/8"	2-1/2" x 5-1/2"	1-5/8" x 5-1/2"	46
C12LDH	Dual Compound with LCD Display and Laser Marker	12"	4,000	L 0° - 52° R 0° - 52°	L 0° - 48° R 0° - 48°	2-3/4" x 8" or 3-1/2" x 7-1/2"	2-3/4" x 5-1/2"	L 1-31/32" x 8" R 1-7/32" x 5-1/2"	46
C12FDH	Dual Compound with Laser Marker	12"	4,000	L 0° - 52° R 0° - 52°	L 0° - 48° R 0° - 48°	2-3/4" x 8" or 3-1/2" x 7-1/2"	2-3/4" x 5-1/2"	L 1-31/32" x 8" R 1-7/32" x 5-1/2"	46
C12LSH	Slide Dual Compound with LCD Display, Laser Marker and Zero Clearance	12"	3,800	L 0° - 46° R 0° - 57°	L 0° - 45° R 0° - 45°	4-3/16" X 12-1/4"	4-3/16" x 8-5/8"	L 2-3/4" x 8-5/8"	47
C12RSH	Slide Dual Compound with Laser Marker and Zero Clearance	12"	3,800	L 0° - 46° R 0° - 57°	L 0° - 45° R 0° - 45°	4-3/16" X 12-1/4"	4-3/16" x 8-5/8"	L 2-3/4" x 8-5/8"	47
C15FB	Miter	15"	3,400	L 0° - 57° R 0° - 57°	n/a	4-3/4" x 7/14"	4-3/4" x 5-7/16"	n/a	47

Woodworking



### Specifications

Amp	.15
Blade Diameter	7-1/4"
No Load Speed	5,800 RPM
Arbor Size	5/8"
Bevel Capacity	.55°
Electric Brake	Yes
Weight	10.5 lbs

### Includes

Box Wrench	.940543
24-Tooth Carbide Tipped Blade	.725213

### Optional

Rip Guide	.302691
-----------	---------

### Specifications

Amp	.15
Blade Diameter	7-1/4"
No Load Speed	5,800 RPM
Arbor Size	5/8"
Bevel Capacity	.55°
Electric Brake	No
Weight	10.1 lbs

### Includes

Case	.321188
24-Tooth Carbide Tipped Blade	.320843
10mm Wrench	.940543

### Optional

Rip Guide	.302691
-----------	---------

### Specifications

Amp	.12
Stroke Length	1-1/4"
No Load Speed	0-3,000 SPM
Full Load Triaxial Vibration	.9,0m/s <sup>2</sup>
Length	18.3"
Weight	9.7 lbs

### Includes

Case	.327054
All Purpose Blade	.725362

### Specifications

Amp	.10
Stroke Length	1-1/8"
No Load Speed	0-2,800 SPM
Length	17-1/8"
Weight	7.3 lbs

### Includes

Case	.327054
All Purpose Blade	.725362
4mm Hex Bar Wrench	.944458

### Features

- IDI (Internal Double Insulation) Technology provides double insulation for significant durability and extended tool life
- Electric brake stops blade rotation within seconds preventing unintended cuts
- Bevel capacity ranges from 0-55 degrees with a positive stop at 45 degrees
- AC/DC switch is operable on any power supply for convenience
- Lightweight and compact for easy transport and maneuverability

### Capacities

45°	1-27/32"
90°	2-3/8"

### Features

- Bevel capacity from 0-55° with adjustable lever stops at 0°, 45° and 55° for a wide range of beveling applications
- Cutting depth lever located to the left of the handle, adds convenience and facilitates ease of use
- Carbon brush access allows easy brush replacement to prolong the life of the tool
- Die-cast aluminum base offers easy to read scales for accurate measurement
- Non-slip Elastomer grip handle maximizes user comfort and control

### Capacities

45°	1-27/32"
90°	2-3/8"

### Features

- Patented User Vibration Protection (UVP) Technology for 65% less full-load tri-axial vibration to significantly reduce vibration transfer to the user
- Two cutting modes- straight and swing for more efficient cuts in wood materials
- Triple sealed to protect the tool from dust and debris generated during use
- Tool-less blade change with a simple lever press for quick replacements
- Variable speed dial and trigger allow for less material waste and more control

### C7BMR

7-1/4" Double Insulated Circular Saw



### C7SB2

7-1/4" Circular Saw



### CR13VBV

12 Amp Low Vibration Reciprocating Saw



### CR13V2

10 Amp Reciprocating Saw



## CJ90VST

Variable Speed Jig Saw with Blower



### Features

- 3-Mode orbital action to increase cutting efficiency through various materials
- Tool-less blade changing system allows for quick and easy replacements
- Powerful dust-blower keeps debris away from the cutting path
- Lock-on, variable speed trigger for ultimate control during use
- Soft, vibration absorbing grip provides greater comfort and a secure hold
- Cast aluminum nickel plated base plate offers solid support and resists scratching the work surface
- Accepts "T" shank blades only

### Specifications

Amp	5.5
No-Load Speed	850 – 3,000 SPM
Stroke Length	3/4"
Orbital Action	3-Modes
Blade Clamp	Tool-less
Weight	4.9 lbs

### Includes

No. 41 Jig Saw Blade	.725389
Allen Wrench	.944458

## CJ110MV

Variable Speed Jig Saw with LED Light & Blower



### Features

- 4-Mode orbital action for accurate and efficient cutting in various materials
- Top mounted LED light and powerful dust blower for convenience
- Tool-less blade changing system allows for quick and easy replacements
- Lock-on, variable speed trigger for ultimate control during use
- Accepts "T" shank blades only

### Specifications

Amp	5.8
No-Load Speed	850 – 3,000 SPM
Stroke Length	1"
Orbital Action	4-Modes
Blade Clamp	Tool-less
Weight	4.9 lbs

### Includes

No. 41 Jig Saw Blades (5pcs)	.725389
Allen Wrench	.944458

## C8FSHE

8-1/2" Sliding Compound Miter Saw with Laser Marker & LED Light

**LASER MARKER**



### Features

- Laser Marker System for exact alignment and predictable blade placement
- Fully adjustable LED work light illuminates the table from any angle
- Linear ball bearing slide system for superior accuracy and ease of use
- Precise compound cuts with 48° bevel angle left and 5° bevel angle right
- Lightweight design for easy portability

### Specifications

Amp	9.2
Blade Diameter	8-1/2"
No-Load Speed	5,500 RPM
Arbor Size	5/8"
Cross Cut Capacity	2-9/16" x 12" (at 90°)
Miter Detent Stops	0°, 15°, 22.5°, 31.6°, 45° (R&L)
Weight	32 lbs

### Includes

8-1/2" 24T TCT Saw Blade	.998840
Dust Bag	.322955
Vise Assembly	.329860
10mm Box Wrench	.940543
Sub Fence	.329464

## C8FSE

8-1/2" Sliding Compound Miter Saw



### Features

- Linear ball bearing slide system for superior accuracy and ease of use
- Precise compound cuts with 48° bevel angle left and 5° bevel angle right
- Lightweight design for easy portability

### Specifications

Amp	9.2
Blade Diameter	8-1/2"
No-Load Speed	5,500 RPM
Arbor Size	5/8"
Cross Cut Capacity	2-9/16" x 12" (at 90°)
Miter Detent Stops	0°, 15°, 22.5°, 31.6°, 45° (R&L)
Weight	31 lbs

### Includes

8-1/2" 24T TCT Saw Blade	.998840
Dust Bag	.322955
Vise Assembly	.329860
10mm Box Wrench	.940543
Sub Fence	.329464

### Ranges

Miter Angle	0-45° L / 0-57° R
Bevel Angle	0-48° L / 0-5° R

### Ranges

Miter Angle	0-45° L / 0-57° R
Bevel Angle	0-48° L / 0-5° R

## UG50Y

Digital Laser Meter  
Details on page 24





### Specifications

Amp	15
Blade Diameter	10"
No-Load Speed	5,000 RPM
Arbor Size	.5/8"
Cross Cut Capacity	2-5/16" x 5-21/32" (at 90°)
Miter Detent Stops	0°, 15°, 22.5°, 31.6°, 45° (R&L)
Weight	26.3 lbs

### Includes

10" 24T TCT Saw Blade	311128
Pivoting Flip Fence	326704
Dust Bag	322955
Vise Assembly	322952
10mm Box Wrench	940543
Material Support Extension	321549

### Features

- Large extended flip fence raises to 4" for cutting crown molding vertically
- Large table with material support extension provides better support
- Thumb actuated positive stops, easy to use for quick miter adjustments
- Lightweight design for easy portability

### Ranges

Miter Angle	0-52° L & R
Bevel Angle	-0-45° L

## C10FCE2

10" Compound Miter Saw



### Specifications

Amp	15
Blade Diameter	10"
No-Load Speed	5,000 RPM
Arbor Size	.5/8"
Cross Cut Capacity	2-5/16" x 5-21/32" (at 90°)
Miter Detent Stops	0°, 15°, 22.5°, 31.6°, 45° (R&L)
Weight	26.5 lbs

### Includes

10" 24T TCT Saw Blade	311128
Pivoting Flip Fence	326704
Dust Bag	322955
Vise Assembly	322952
10mm Box Wrench	940543
Hex Bar Wrench (4mm)	944458
Material Support Extension	321549

### Features

- Laser Marker System for exact alignment and predictable blade placement
- Large extended flip fence raises to 4" for cutting crown molding vertically
- Large table with material support extension provides better support
- Thumb actuated positive stops, easy to use for quick miter adjustments
- Lightweight design for easy portability

### Ranges

Miter Angle	0-52° L & R
Bevel Angle	-0-45° L

## C10FCH2

10" Compound Miter Saw  
with Laser Marker

**LASER MARKER**



### Specifications

Amp	12
Blade Diameter	10"
No-Load Speed	3,800 RPM
Arbor Size	.5/8"
Cross Cut Capacity	3-11/32" x 12-9/32" (at 90°)
Miter Detent Stops	0°, 15°, 22.5°, 31.6°, 45° (R&L)
Weight	43 lbs

### Includes

10" 40T TCT Saw Blade	310878
Pivoting Flip Fence	321385
Dust Bag	322955
10mm Box Wrench	940543

### Features

- Linear ball bearing slide system for superior accuracy and cut capacity
- Soft start function reduces noise and recoil during startup
- Electric brake stops the rotation of the blade within seconds preventing unintended cuts
- Adjustable flip fence supports work piece for improved stability

### Ranges

Miter Angle	0-45° L & 0-57° R
Bevel Angle	0-45° L & R

## C10FSB

10" Sliding Dual Compound Miter Saw



### Specifications

Amp	12
Blade Diameter	10"
No-Load Speed	3,800 RPM
Arbor Size	.5/8"
Cross Cut Capacity	3-11/32" x 12-9/32" (at 90°)
Miter Detent Stops	0°, 15°, 22.5°, 31.6°, 45° (R&L)
Weight	43 lbs

### Includes

10" 40T TCT Saw Blade	310878
Pivoting Flip Fence	321385
Dust Bag	322955
10mm Box Wrench	940543

### Features

- Laser Marker System for exact alignment and predictable blade placement
- Linear ball bearing slide system for superior accuracy and cut capacity
- Soft start function reduces noise and recoil during startup
- Electric brake stops the rotation of the blade within seconds preventing unintended cuts
- Adjustable flip fence supports work piece for improved stability

### Ranges

Miter Angle	0-45° L & 0-57° R
Bevel Angle	0-45° L & R

## C10FSH

10" Sliding Dual Compound Miter Saw  
with Laser Marker

**LASER MARKER**



Woodworking

## C12LCH

12" Compound Miter Saw with Laser Marker & Digital Display

**DIGITAL  
&  
LASER**



### Features

- Digital LCD (Liquid Crystal Display) for clear and accurate miter and bevel readings
- Laser Marker System for exact alignment and predictable blade placement
- Micro bevel adjustment for fine tuning bevel angles
- Thumb actuated positive stops, easy to use for quick miter adjustments

### Ranges

Miter Angle . . . . . 0-52° L & R  
Bevel Angle . . . . . -3 - 48° L

### Specifications

Amp . . . . . 15  
Blade Diameter . . . . . 12"  
No-Load Speed . . . . . 4,000 RPM  
Arbor Size . . . . . 1"  
Cross Cut Capacity . . . . . 2-1/2" x 7-7/8" (at 90°)  
Miter Detent Stops . . . . . 0°, 15°, 22.5°, 31.6°, 45° (R&L)  
Weight . . . . . 43 lbs

### Includes

12" 32T TCT Saw Blade . . . . . 726100  
Dust Bag . . . . . 322955  
Vise Assembly . . . . . 323677  
Box Wrench . . . . . 985051  
Hex Bar Wrench . . . . . 944458

## C12FCH

12" Compound Miter Saw with Laser Marker

**LASER MARKER**



### Features

- Laser Marker System for exact alignment and predictable blade placement
- Micro bevel adjustment for fine tuning bevel angles
- Large pivoting fence raises fence height to 5-1/8" for cutting crown molding vertically
- Thumb actuated positive stops, easy to use for quick miter adjustments

### Ranges

Miter Angle . . . . . 0-52° L & R  
Bevel Angle . . . . . -3-48° L

### Specifications

Amp . . . . . 15  
Blade Diameter . . . . . 12"  
No-Load Speed . . . . . 4,000 RPM  
Arbor Size . . . . . 1"  
Cross Cut Capacity . . . . . 2-1/2" x 7-7/8" (at 90°)  
Miter Detent Stops . . . . . 0°, 15°, 22.5°, 31.6°, 45° (R&L)  
Weight . . . . . 41.9 lbs

### Includes

12" 32T TCT Saw Blade . . . . . 726100  
Dust Bag . . . . . 322955  
Vise Assembly . . . . . 323677  
Box Wrench . . . . . 985051  
Hex Bar Wrench . . . . . 944458

## C12LDH

12" Dual Compound Miter Saw with Laser Marker & Digital Display

**DIGITAL  
&  
LASER**



### Features

- Digital LCD (Liquid Crystal Display) for clear and accurate miter and bevel readings
- Laser Marker System for exact alignment and predictable blade placement
- After major bevel angle is secured, micro-bevel adjustment knob can be used to dial-in to a precise angle without the weight of the saw head compromising the accuracy

### Ranges

Miter Angle . . . . . 0-52° L & R  
Bevel Angle . . . . . 0-48° L & R

### Specifications

Amp . . . . . 15  
Blade Diameter . . . . . 12"  
No-Load Speed . . . . . 4,000 RPM  
Arbor Size . . . . . 1"  
Cross Cut Capacity . . . . . 2-3/4" x 8" (at 90°)  
Miter Detent Stops . . . . . 0°, 15°, 22.5°, 31.6°, 45° (R&L)  
Weight . . . . . 47.4 lbs

### Includes

12" 32T TCT Saw Blade . . . . . 726100  
Dust Bag . . . . . 322955  
Vise Assembly . . . . . 323677  
Box Wrench . . . . . 985051  
Hex Bar Wrench . . . . . 944458

## C12FDH

12" Dual Compound Miter Saw with Laser Marker

**LASER MARKER**



### Features

- Laser Marker System for exact alignment and predictable blade placement
- Tall, pivoting aluminum fence that stands at a height of 5-1/8" allows crown molding to be cut vertically for convenience
- After major bevel angle is secured, micro-bevel adjustment knob can be used to dial-in to a precise angle without the weight of the saw head compromising the accuracy

### Ranges

Miter Angle . . . . . 0-52° L & R  
Bevel Angle . . . . . 0-48° L & R

### Specifications

Amp . . . . . 15  
Blade Diameter . . . . . 12"  
No-Load Speed . . . . . 4,000 RPM  
Arbor Size . . . . . 1"  
Cross Cut Capacity . . . . . 2-3/4" x 8" (at 90°)  
Miter Detent Stops . . . . . 0°, 15°, 22.5°, 31.6°, 45° (R&L)  
Weight . . . . . 46.3 lbs

### Includes

12" 32T TCT Saw Blade . . . . . 726100  
Dust Bag . . . . . 322955  
Vise Assembly . . . . . 323677  
Box Wrench . . . . . 985051  
Hex Bar Wrench . . . . . 944458

Woodworking

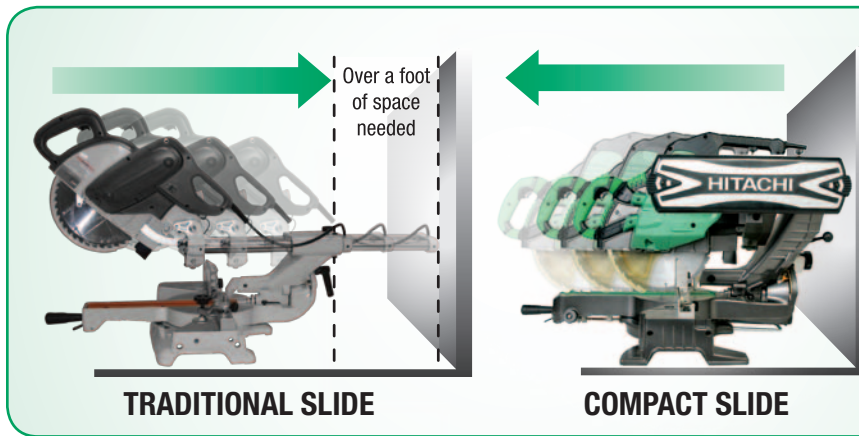

The C12LSH and C12RSH revolutionary compact slide system is unlike traditional models that require over 12 inches of clearance behind the tool to accommodate the extension of the sliding rails.

Now, with the C12LSH and C12RSH, the sliding arm can also move along fixed rails, enabling the saw to sit nearly flush against a wall on a bench top without compromising the range of movement. The compact slide system eliminates the need for large work areas that a conventional slide saw would occupy.

### Specifications

Amp	15
Blade Diameter	12"
No-Load Speed	3,800 RPM
Arbor Size	1"
Cross Cut Capacity	4-3/16" x 12-1/4" (at 90°)
Miter Detent Stops	0°, 15°, 22.5°, 31.6°, 45° (R&L)
Weight	66.1 lbs

### Features

- Revolutionary compact slide system allows the saw head to slide along fixed rails, eliminating the need for rear clearance
- Top-mounted, digital, LCD scale swivels to provide clear and accurate miter and bevel readings from any angle
- Laser Marker System for exact alignment and predictable blade placement
- Micro miter and micro bevel adjustment knobs to dial-in to precise angles

### Includes

12" 32T TCT Saw Blade	726100
Dust Bag	322955
Vise Assembly	324378
17mm Box Wrench	985051

### Ranges

Miter Angle	0-46° L & 0-57° R
Bevel Angle	0-45° L & R

### C12LSH

12" Sliding Dual Compound Miter Saw with Laser Marker & Digital Display



**DIGITAL & LASER**



### Specifications

Amp	15
Blade Diameter	12"
No-Load Speed	3,800 RPM
Arbor Size	1"
Cross Cut Capacity	4-3/16" x 12-1/4" (at 90°)
Miter Detent Stops	0°, 15°, 22.5°, 31.6°, 45° (R&L)
Weight	63.9 lbs

### Features

- Revolutionary compact slide system allows the saw head to slide along fixed rails, eliminating the need for rear clearance
- Laser Marker System for exact alignment and predictable blade placement
- Micro miter and micro bevel adjustment knobs to dial-in to precise angles

### Includes

12" 32T TCT Saw Blade	726100
Dust Bag	322955
Vise Assembly	324378
17mm Box Wrench	985051

### Ranges

Miter Angle	0-46° L & 0-57° R
Bevel Angle	0-45° L & R

### C12RSH

12" Sliding Dual Compound Miter Saw with Laser Marker



**LASER MARKER**



### Specifications

Amp	15
Blade Diameter	15"
No-Load Speed	3,400 RPM
Arbor Size	1"
Cross Cut Capacity	4-3/4" x 7-1/4" (at 90°)
Miter Detent Stops	0°, 15°, 22.5°, 30°, 45°, 57° (R&L)
Weight	55 lbs

### Features

- Electric brake feature halts the rotation of the blade within seconds preventing unintended cuts
- Eleven positive stops on miter index for easy to read measurements and quick setting
- Extension guide supports longer stock without warping
- Dust collector attachment minimizes airborne particles

### Includes

15" 80T Saw Blade	974651Z
Dust Bag	976478
Vise Assembly	988897
17mm Box Wrench	985051
Extension Guide Assembly	974661
Holder Assembly	974562
Stopper	974561
Screw Assembly	988104

### Ranges

Miter Angle	0-57° L & R
-------------	-------------

### C15FB

15" Miter Saw



**UG50Y**  
Digital Laser Meter  
Details on page 24

## UU610

Universal Work Station -  
Supports 20ft of Work Material



### Features

- Heavy-duty aluminum construction allows the beam to support up to 500lbs
- Fully adjustable 12" work supports can handle 20ft of work material
- Fully retractable length of only 4.5 ft., fits sideways in a pickup
- Dual extension arms accepts router and vise accessories

### Specifications

Construction	Aluminum
Support Weight	500 lbs
Extension Arms	2
Retracted Length	4.5 ft
Supported Length	20 ft
Weight	40 lbs

### Includes

Wheel Kit	726215
Universal Tool Mount	726213
Adjustable Flip Stop	726212

## UU610CZ

Universal Work Station -  
Supports 12ft of Work Material



### Features

- Heavy-duty aluminum construction allows the beam to support up to 500lbs
- Fully adjustable 12" work supports can handle 12ft of work material
- Fully retractable length of only 3.75 ft., fits sideways in a pickup
- Dual extension arms accepts router and vise accessories

### Specifications

Construction	Aluminum
Support Weight	500 lbs
Extension Arms	2
Retracted Length	3.75 ft
Supported Length	12 ft
Weight	38.5 lbs

### Includes

Wheel Kit	726215
Universal Tool Mount	726213

## M12VC

2-1/4 Peak HP Variable Speed  
Fixed Base Router



### Features

- 2-stage motor release clamp for quick and accurate depth adjustments and base changes
- Electronic speed control maintains constant RPMs even as load varies
- Class leading noise level, only 79.5dB for a quieter workshop

### Specifications

Amp	11
Peak HP	2-1/4
Type	Fixed Base
Plunge Stroke	N/A
No-Load Speed	8,000 - 24,000 RPM
Collet	1/2" & 1/4"
Weight	7.3 lbs

### Includes

1/4" Collet Chuck	323293
1/2" Collet Chuck	323421
Template Guide Adapter	323272
Centering Gauge	323296
Wrenches (16mm, 23mm)	323294, 323295
Hex Bar Wrench (4mm)	944458
Hex Socket HD Bolt M5x10 (10 PCS)	949819

## KM12VC

2-1/4 Peak HP Variable Speed  
Fixed/Plunge Base Router Kit



### Features

- 2-stage motor release clamp for quick and accurate depth adjustments and base changes
- Electronic speed control maintains constant RPMs even as load varies
- Fine depth adjustment (plunge base) for precise depth control
- Class leading noise level, only 79.5dB for a quieter workshop

### Specifications

Amp	11
Peak HP	2-1/4
Type	Fixed/Plunge Base
Plunge Stroke	2-1/2"
No-Load Speed	8,000 - 24,000 RPM
Collet	1/2" & 1/4"
Weight (fixed base)	7.3 lbs
Weight (plunge base)	9.9 lbs

### Includes

1/4" Collet Chuck	323293
1/2" Collet Chuck	323421
Template Guide Adapter	323272
Centering Gauge	323296
Wrenches (16mm, 23mm)	323294, 323295
Hex Bar Wrench (4mm)	944458
Sub Base Plate	323297
Hex Socket HD Bolt M5x10 (10 PCS)	949819
Case	323358

### Optional Accessories

TCT 1/2" Shank Straight Router Bit	313765
TCT 1/4" Shank Straight Router Bit	971878
Plunge Base	323349
Dust Collector Set	323346
Straight Guide Assembly	323342
Straight Guide	323344

### Optional Accessories

TCT 1/2" Shank Straight Router Bit	313765
TCT 1/4" Shank Straight Router Bit	971878
Dust Collector Set	323346
Straight Guide Assembly	323342
Straight Guide	323344

### Specifications

Amp	15
Peak HP	3-1/4
Type	Plunge Base
Plunge Stroke	2-9/16"
No-Load Speed	8,000 – 22,000 RPM (M12SA2 22,000 RPM)
Collet	1/2" & 1/4"
Weight	13.9 lbs (M12SA2 13.7 lbs)

### Includes

1/4" Collet Chuck	323293
1/2" Collet Chuck	301795
Template Guide Adapter	325224
Centering Gauge	325223
Straight Guide	956797
Dust Adapter	325215
Guide Bar	325216
Hex Bar Wrench (4mm)	944458
Wrench	323295
Wing Bolt	301806

### Specifications

Amp	15
Peak HP	3-1/4
Type	Plunge Base
Plunge Stroke	2-9/16"
No-Load Speed	8,000 – 22,000 RPM
Collet	1/2" & 1/4"
Weight	11.7 lbs

### Includes

1/4" Collet Chuck	323293
Template Guide Adapter	325224
Template Guide	956790
Wrench (23mm)	323295
Straight Guide	956797

### Specifications

Amp	3.4
Max Cutting Width	3-1/4"
Max Cutting Depth	1/32"
No-Load Speed	15,000 RPM
Weight	6.1 lbs

### Includes

Guide	958842Z
Box Wrench	940543
Blade Setting Gauge	958736
Blades	324289
Carrying Case	MP100000

### Features

- Variable speed dial is conveniently located on the handle so the user can finely adjust the rotation speed without removing a hand or eyes from the work piece
- Unique quick and fine adjustment knob combines both functionalities into the same mechanism to quickly and accurately dial plunge depths
- Equipped with an improved collet chuck that secures the bit into the armature shaft for maximum hold
- Dust guide diverts dust and debris away from the work piece and user

### Optional Accessories

Trimmer Guide	956794
---------------	--------

### Features

- Lightweight and compact for easy maneuverability
- Adjustable handle ensures maximum operator control
- Slide type switch for easy operation

### Features

- 3.4 Amp motor, forcible power for efficient cuts
- Exclusive blade setting gauge, for simple blade adjustment
- Center V-groove, located on base sole for bevel cutting
- Aluminum alloy base, ensures scratch-free work
- 6.1 lbs, lightweight design facilitates maneuverability and ease of use

### Optional Accessories

Trimmer Guide	956794
---------------	--------

### M12V2 - M12SA2

3-1/4 Peak HP Variable Speed  
Plunge Router



**M12SA2**  
Single Speed  
(22,000 rpm)



### M12VE

3-1/4 Peak HP Variable Speed  
Plunge Router



### P20SBK

3-1/4" Planer



## SANDING & POLISHING QUICK REFERENCE

Model	Type	Sheet Size	Amps	No-Load Speed	Orbit Diameter	Dust Collection	Weight (lbs)	Page
SV12SG	1/4 Sheet Orbital	4-1/2" x 5"	1.7	14,000 OPM	1/16"	Yes	2.4	51
SV13YA	Random Orbit	5" Round	2.4	7,000 - 12,000 OPM	1/8"	Yes	3.1	51
SV13YB	Random Orbit	5" Round	2.0	12,000 OPM	1/8"	Yes	3.1	51
SB8V2	Belt	3" x 21"	9.0	820 - 1,475 ft/min	n/a	Yes	9.5	51
S18SB	Vertical Sander	7"	6.2	4,500 RPM	n/a	No	4.4	52
SP18VA(H)	Sander/Polisher	7"	11	0 - 600 / 3,400 RPM	n/a	No	6.2	52



Sanding / Polishing

### Specifications

Amps	1.7
No-Load Speed	14,000 OPM
Pad Size	4-3/8" x 4"
Sheet Size	4-1/2" x 5/12"
Orbit Diameter	1/16"
Weight	2.4 lbs

### Includes

Dust Bag	323004
Sanding Paper (80 Grit)	310348

### Optional

Perforated Felt Pad	310354
Perforated Velcro Pad	310355
Perforated Adhesive Pad	311978
Perforated 5" Round Pad	310356

### Features

- Clamp system, easy to use for quick and easy sanding sheet changes
- Dust collection system to reduce airborne particles
- Easy-to-palm handle provides smooth touch and comfortable grip
- Soft Elastomer covered grip reduces vibration

**SV12SG**  
1/4 Sheet Orbital Finishing Sander



### Specifications

Amps	2.4
No-Load Speed	7,000 - 12,000 OPM
Pad Size	5" Round
Orbit Diameter	1/8"
Weight	3.1 lbs

### Includes

Dust Bag	323004
Sanding Paper (5 pcs, 5" A-P120)	308519

### Optional

Polyester Buffer	308515
Polishing Sponge (6")	312518

### Features

- Efficient sanding performance removing more stock in less time
- Complete ball bearing construction for smooth, precise operation
- Hook and loop pad system allows you to change sanding sheets quickly and easily

**SV13YA**  
5" Variable Speed Random Orbit Finishing Sander



### Specifications

Amps	2.0
No-Load Speed	12,000 OPM
Pad Size	5" Round
Orbit Diameter	1/8"
Weight	3.1 lbs

### Includes

Dust Bag	323004
Sanding Paper (5 pcs, 5" A-P120)	308519

### Optional

Polyester Buffer	308515
Polishing Sponge (6")	312518

### Features

- Efficient sanding performance removing more stock in less time
- Complete ball bearing construction for smooth, precise operation
- Hook and loop pad system allows you to change sanding sheets quickly and easily

**SV13YB**  
5" Single Speed Random Orbit Finishing Sander



### Specifications

Amps	9.0
No-Load Speed	820 - 1,475 FT/MIN
Belt Size	3" x 21"
Weight	9.5 lbs

### Includes

Dust Bag	323011
Sanding Belt	753242

### Features

- Wear-resistant V-belt drives the sander for double the service life
- Flush surface design allows for quick and even sanding
- Tracking window improves visibility of sanding surface and sanding belt during use
- Left-side mounted dust collection bag improves corner sanding applications while reducing airborne particles to keep work area clean

**SB8V2**  
3" x 21" Variable Speed Belt Sander



## S18SB

7" Vertical Sander



### Features

- Vertically positioned design for improved balance and control
- Air deflector prevents exhaust and debris from reaching the operator
- Trigger lock-on button reduces user fatigue during continuous use
- High overload durability prevents burnout during aggressive sanding operations

### Specifications

Amps	6.2
Wheel Diameter	7"
Spindle	5/8" x 11
No-Load Speed	4,500 RPM
Weight	4.4 lbs

## SP18VA(H)

7" Disc Sander/Polisher



### Features

- Heat resistant bearing chamber and iron ball bearings to extend tool life and durability
- Three electronically controlled devices; constant speed control, soft start, and two-way variable speed controls located on both the trigger and dial for flexibility and control
- Loop-handle design for efficiency and comfort

### Specifications

Amps	11
Wheel Diameter	7"
Spindle	5/8" x 11
No-Load Speed	0 - 600 / 3,400 RPM
Weight	6.2 lbs

### Includes

Loop Handle	320949
Hook and Loop Pad	321645
Hex Bar Wrench (8mm)	955857
Bolt Washers	949434
Hex Socket HD Bolt	949844

## POLISHING ACCESSORIES



P/N 725400



P/N 725401

Part Number	Description	Material	Diameter	Qty
308515	Hook & Loop Buffing Pad		5"	3
312518	Hook & Loop Polishing Sponge		6"	1
949103	Tie-On Polishing & Buffing Bonnet	100% 4-ply tufted twisted wool knit	7-1/2"	1
725400	Tie-On Polishing & Buffing Bonnet	50/50 wool/acrylic blend lambswool clear luster knit	7-1/2"	1
725401	Hook & Loop Polishing & Buffing Bonnet	100% 4-ply tufted twisted wool knit	7-1/2"	1
725402	Hook & Loop Polishing & Buffing Bonnet	50/50 wool/acrylic blend lambswool clear luster knit	7-1/2"	1

See pages 148-151 for more sanding and polishing accessories



## GRINDER QUICK REFERENCE

Model	Benefit	Amps	AC / DC	Wheel Dia.	RPMs	Spindle	Trigger Lock	Weight	Page
G10SS		5.0	No	4"	11,000	M10 x 1.25	Yes	3.1	54
G10SR3		6.0	No	4"	10,000	M10 x 1.25	Yes	3.1	54
G18DL	<i>Lithium-Ion</i>	n/a	18V Li-Ion	4-1/2"	9,100	5/8" x 11	Yes	4.2	15
G12SS		5.0	No	4-1/2"	11,000	5/8" x 11	Yes	3.1	54
G12SR3		6.0	No	4-1/2"	10,000	5/8" x 11	Yes	3.1	54
G12SA3		8.0	Yes	4-1/2"	10,000	5/8" x 11	Yes	4.2	55
G12SE2		9.5	Yes	4-1/2"	10,000	5/8" x 11	Yes	4.2	55
G12SE2P9		9.5	Yes	4-12"	10,000	5/8" x 11	No	4.2	55
G12VA	Variable Speed	13.0	No	4-1/2"	2,800 - 10,000	5/8" x 11	Yes	4.4	55
G13SP		7.5	No	5"	9,500	5/8" x 11	Yes	4.6	55
G13SC2		11.0	No	5"	10,000	5/8" x 11	Yes	6.2	56
G13SC2P9		11.0	No	5"	10,000	5/8" x 11	No	6.2	56
G13VA	Variable Speed	13.0	No	5"	2,800 - 10,000	5/8" x 11	Yes	4.4	56
G18SS		15.0	No	7"	6,000	5/8" x 11	Yes	9.5	56
G18SR		15.0	Yes	7"	6,000	5/8" x 11	Yes	9.5	57
G18MR		15.0	Yes	7"	6,000	5/8" x 11	Yes	11.9	57
G18MRP9	<b>FDI</b> INTERNAL DOUBLE INSULATION	15.0	Yes	7"	6,000	5/8" x 11	No	11.9	57
G18SCY	<b>FDI</b> INTERNAL DOUBLE INSULATION	15.0	Yes	7"	6,000	5/8" x 11	Yes	11.2	57
G23SR	<b>UVP</b> USER VERTICAL PROTECTION	15.0	Yes	9"	6,000	5/8" x 11	Yes	9.5	57
G23MR		15.0	Yes	9"	6,000	5/8" x 11	Yes	11.9	58
G23MRP9	<b>FDI</b> INTERNAL DOUBLE INSULATION	15.0	Yes	9"	6,000	5/8" x 11	No	11.9	58
G23SCY	<b>FDI</b> INTERNAL DOUBLE INSULATION	15.0	Yes	9"	6,000	5/8" x 11	Yes	11.2	58
GP10DL	<b>UVP</b> USER VERTICAL PROTECTION	n/a	12V Peak		5,000 - 35,000	1/8" Collet	Yes	1.06	22
GP2S2	<i>Lithium-Ion</i>	4.7	No	1"	29,000	1/4" Collet	Yes	3.7	58

## G10SS

4" 5-Amp Angle Grinder



### Features

- Trigger lock-on for comfortable continuous operation
- Small perimeter grip and forward-canted side handle add user comfort
- Low-profile gear housing and a compact body make working in tight areas possible

### Specifications

Amps	5
Wheel Diameter	4"
Spindle Thread	M10 x 1.25
No-Load Speed	11,000 RPM
Weight	3.1 lbs

### Includes

Wheel Guard	301948
Side Handle	318312
Wrench	313933

## G10SR3

4" 6-Amp Angle Grinder



### Features

- Trigger lock-on for comfortable continuous operation
- Left-mounted side switch with quick-off feature for added safety
- Low-profile gear case to get into the tightest areas
- Externally accessible carbon brushes for simplified on-site maintenance and extended tool life

### Specifications

Amps	6
Wheel Diameter	4"
Spindle Thread	M10 x 1.25
No-Load Speed	10,000 RPM
Weight	3.1 lbs

### Includes

Wheel Guard	301948
Side Handle	318312
Wrench	313933
Abrasive Depressed Center Wheel (1pc)	727506B10

## G12SS

4-1/2" 5-Amp Angle Grinder



### Features

- Low-profile gear housing and a compact body make working in tight areas possible
- Trigger lock-on allows continuous operation
- Small perimeter grip and forward-canted side handle add user comfort

### Specifications

Amps	5
Wheel Diameter	4-1/2"
Spindle Thread	5/8" x 11
No-Load Speed	11,000 RPM
Weight	3.1 lbs

### Includes

Wheel Guard	315492
Side Handle	318312
Wrench	313933

## G12SR3

4-1/2" 6-Amp Angle Grinder with 5 Abrasive Wheels



727535



### Features

- Trigger lock-on for comfortable, continuous operation
- Low-profile gear case to get into the tightest areas
- Small diameter grip for a comfortable hold
- Left-mounted side switch with quick-off feature for added safety

### Specifications

Amps	6
Wheel Diameter	4-1/2"
Spindle Thread	5/8" x 11
No-Load Speed	10,000 RPM
Weight	3.1 lbs

### Includes

Wheel Guard	315492
Side Handle	318312
Wrench	938332Z
Abrasive Depressed Center Wheel (5pcs)	727535B10
Carrying Case	319375

Metalworking

### Specifications

Amps	8
Wheel Diameter	4-1/2"
Spindle Thread	.5/8" x 11
No-Load Speed	10,000 RPM
Weight	4.2 lbs

### Includes

Wheel Guard	319656
Side Handle	956633
Spanner Wrench	938332Z
Abrasive Depressed Center Wheel (1pc)	727535B10

### Specifications

Amps	9.5
Wheel Diameter	4-1/2"
Spindle Thread	.5/8" x 11
No-Load Speed	10,000 RPM
Weight	4.2 lbs

### Includes

Wheel Guard	311745
Side Handle	318322
Spanner Wrench	938332Z
Abrasive Depressed Center Wheel (1pc)	727538B10

### Specifications

Amps	13
Wheel Diameter	4-1/2"
Spindle Thread	.5/8" x 11
No-Load Speed	2,800 - 10,000 RPM
Weight	4.4 lbs

### Includes

Wheel Guard	311745
Side Handle	956633
Spanner Wrench	938332Z
Abrasive Depressed Center Wheel (1pc)	727538B10

### Specifications

Amps	7.5
Wheel Diameter	5"
Spindle Thread	.5/8" x 11
No-Load Speed	9,500 RPM
Weight	4.6 lbs

### Includes

Wheel Guard	994321
Side Handle	994322
Wrench	938332Z
Abrasive Depressed Center Wheel (1pc)	727566B10

### Features

- Achieves highest overload durability in its class thanks to an improved cooling mechanism and the high output motor for efficiency and higher resistance to burnout
- On/Off switch mounted on the top allows the user to comfortably operate the tool whether right or left handed
- Compact design and short body facilitates maneuverability and ease of use on any worksite

### Features

- Highly durable, up to twice the overload durability of some competitive models
- Large paddle switch can lock-on or be controlled by user as needed
- Carbon brush access allows user to replace brush as needed to greatly prolong the life of the tool
- Trigger lock-on for comfortable continuous operation

### Features

- Variable speed for ultimate control and precision
- Soft start and kick-back prevention for added safety
- Class-leading motor power with overload durability

### Features

- Best in class 1220W input power allowing for 9,500 rpm
- Dust seal for dust reduction near the ball bearings for extending motor life
- Brush Cover for external carbon brush change
- Side handle for 2 position operation

### G12SA3

4-1/2" 8-Amp Angle Grinder, AC/DC



### G12SE2

4-1/2" 9.5-Amp Angle Grinder, AC/DC



G12SE2P9  
Without Lock-On  
Switch



### G12VA

4-1/2" 13-Amp Variable Speed  
Angle Grinder



### G13SP

5" 7.5-Amp Angle Grinder



## G13SC2

5" 11-Amp Angle Grinder



**G13SC2P9**  
Without Lock-On  
Switch



### Features

- Low-profile head permits access in tight areas
- Dust-proof construction prolongs armature, switch and bearing life
- Removable side handle improves control and comfort
- Trigger lock-on for comfortable continuous operation

### Specifications

Amps	11
Wheel Diameter	5"
Spindle Thread	5/8" x 11
No-Load Speed	10,000 RPM
Weight	6.2 lbs

### Includes

Wheel Guard	320213
Side Handle	318312
Spanner Wrench	937913Z
Abrasive Depressed Center Wheel (1pc)	727565B10

## G13VA

5" 13-Amp Variable Speed  
Angle Grinder



### Features

- Variable speed for ultimate control and precision
- Soft start and kick-back prevention for added safety
- Class-leading motor power with overload durability

### Specifications

Amps	13
Wheel Diameter	5"
Spindle Thread	5/8" x 11
No-Load Speed	2,800 - 10,000 RPM
Weight	4.4 lbs

### Includes

Wheel Guard	311742
Side Handle	956633
Spanner Wrench	938332Z
Abrasive Depressed Center Wheel (1pc)	727568B10

## G18SS

7" 15-Amp Angle Grinder



### Features

- Tool-less wheel guard can be adjusted to the desired angle
- Specially sealed armature coil designed to reduce ingested debris and prolong tool life
- Externally accessible carbon brushes for simplified on-site maintenance and extended tool life

### Specifications

Amps	15
Wheel Diameter	7"
Spindle Thread	5/8" x 11
No-Load Speed	6,000 RPM
Weight	9.5 lbs

### Includes

Wheel Guard	330037
Side Handle	937981
Spanner Wrench	937913Z

### Specifications

Amps	15
Wheel Diameter	7"
Spindle Thread	.5/8" x 11
No-Load Speed	6,000 RPM
Weight	9.5 lbs

### Includes

Wheel Guard	937960Z
Side Handle	937981
Spanner Wrench	325491

### Specifications

Amps	15
Wheel Diameter	7"
Spindle Thread	.5/8" x 11
No-Load Speed	6,000 RPM
Weight	11.9 lbs

### Includes

Wheel Guard	324266
Side Handle	322411
Spanner Wrench	937913Z

### Specifications

Amps	15
Wheel Diameter	7"
Spindle Thread	.5/8" x 11
No-Load Speed	6,000 RPM
Weight	11.2 lbs

### Includes

Wheel Guard	324266
Side Handle	322411
Spanner Wrench	325491

### Specifications

Amps	15
Wheel Diameter	9"
Spindle Thread	.5/8" x 11
No-Load Speed	6,000 RPM
Weight	9.5 lbs

### Includes

Wheel Guard	937984Z
Side Handle	937981
Spanner Wrench	325491

### Features

- Compact and lightweight (measuring a full inch shorter than previous models and weighing in at under 10 lbs) for reduced fatigue and improved control
- Trigger lock-on for comfortable continuous operation
- Armature coil dual-sealed with varnish and heat resistant adhesive to protect the motor from wear caused by dust and debris

### Features

- IDI (Internal Double Insulation) Technology prolongs tool life by providing a durable metal housing, reducing vibration and extending brush life, while realizing the double insulation characteristics of plastic housing tools
- Dust-proof labyrinth construction prolongs armature, switch and bearing life
- Carbon brush access allows user to replace brush as needed to greatly prolong the life of the tool
- Trigger lock-on for comfortable continuous operation

### Features

- Features User Vibration Protection (UVP) technology that reduces full load tri-axial vibration by up to 30%
- Two part stator coil design offers 1.5 times the surface area for 25% cooler operation
- Dust protected switches and sealed armatures protect the internal components from harmful dust and debris

### Features

- Compact and lightweight (measuring a full inch shorter than previous models and weighing in at under 10 lbs) for reduced fatigue and improved control
- Trigger lock-on for comfortable continuous operation
- Armature coil dual-sealed with varnish and heat resistant adhesive to protect the motor from wear caused by dust and debris

### G18SR

7" 15-Amp Angle Grinder, AC/DC



### G18MR

7" 15-Amp Angle Grinder, AC/DC



**G18MRP9**  
Without Lock-On Switch



### G18SCY

7" 15-Amp Low Vibration Angle Grinder, AC/DC



### G23SR

9" 15-Amp Angle Grinder, AC/DC



## G23MR

9" 15-Amp Angle Grinder, AC/DC



**G23MRP9**  
Without Lock-On  
Switch



### Features

- IDI (Internal Double Insulation) Technology prolongs tool life by providing a durable metal housing, reducing vibration and extending brush life, while realizing the double insulation characteristics of plastic housing tools
- Dust-proof labyrinth construction prolongs armature, switch and bearing life
- Carbon brush access allows user to replace brush as needed to greatly prolong the life of the tool
- Trigger lock-on for comfortable continuous operation

### Specifications

Amps	15
Wheel Diameter	9"
Spindle Thread	5/8" x 11
No-Load Speed	6,000 RPM
Weight	11.9 lbs

### Includes

Wheel Guard	324267
Side Handle	322411
Spanner Wrench	937913Z

## G23SCY

9" 15-Amp Low Vibration Angle Grinder, AC/DC



### Features

- Features User Vibration Protection (UVP) technology that reduces full load tri-axial vibration by up to 30%
- Two part stator coil design offers 1.5 times the surface area for 25% cooler operation
- Dust protected switches and sealed armatures protect the internal components from harmful dust and debris

### Specifications

Amps	15
Wheel Diameter	9"
Spindle Thread	5/8" x 11
No-Load Speed	6,000 RPM
Weight	11.2 lbs

### Includes

Wheel Guard	324267
Side Handle	322411
Spanner Wrench	325491

## GP2S2

1" 4.7-Amp Die Grinder



### Features

- Large slide switch for easy one-hand operation
- Compact and lightweight at just 14-3/32" in length and a mere 3.7 lbs
- Internal carbon brushes creating a slim, sleek feel for excellent control
- Ideal for finishing dies, press work, die casting and molding, and grinding of machines parts

### Specifications

Amps	4.7
Wheel Diameter	1"
Collet	1/4"
No-Load Speed	29,000 RPM
Weight	3.7 lbs

### Includes

Collet Chuck	932666Z
Wrenches (X2)	936638, 936553



### Specifications

Amps	15
Wheel Diameter	12"
No-Load Speed	5,000 RPM
Weight	23.1 lbs

### Features

- Replaceable cutting wheel without removal of base for quick changes
- Ball and needle bearing construction for added durability
- Auto stop carbon brushes protect armature and extend tool life

### CC12Y

12" Portable Cut Off Saw, AC/DC



### Includes

Metal Cutting Wheel (12")	727665B10
Masonry Cutting Wheel (12")	727675B10
Spanner Wrench	985607
6mm Hex Bar Wrench	872422

### Capacities

Depth of Cut per Pass	2"
Max. Depth of Cut	4"

### Specifications

Amps	15
Wheel Diameter	14"
No-Load Speed	3,800 RPM
Weight	36.4 lbs

### Features

- Portable, rugged and lightest in class to withstand daily transport between trucks and jobsites
- Adjustable fence is easy to use and miter 45 degrees to the right or left for versatility
- Quick-lock/release vise provides fast feeding and changing of materials of different sizes

### CC14SFS

14" Portable Chop Saw



### Includes

Cut-Off Wheel (14")	727685B10
8mm Hex Bar Wrench	955857

### Capacities

Bar	2-9/16"
Pipe	4-47/64"
Shaped Steel	5-1/8" x 5-1/8"

## METAL CUTTING BLADES



Part No.	Diameter	Arbor	Description
726111	7-1/4"	5/8"	48 Tooth TCT TCG dry cutting
725665B10	12"	1"	Cut-Off Wheel for Steel/Inox Cutting
725666B10	12"	20mm	Cut-Off Wheel for Steel/Inox Cutting
727685B10	14"	1"	Cut-Off Wheel for Steel/Inox Cutting
727686B10	14"	1"	Cut-Off Wheel for Steel/Inox Bar Cutting
727687B10	14"	1"	Cut-Off Wheel for Steel/Inox Stud Cutting
727688B10	14"	1"	High Performance Cut-Off Wheel for Light Gauge Stud Fast Cutting
726137	14"	1"	80 Tooth TCT TCG for dry cutting

See pages 84 and 140 for more blades and bonded abrasives

## VB16Y Rebar Cutter Bender



### Features

- Uniformly bends up to No.5 (3/8", 1/2", 5/8") Grade 60 rebar at a maximum angle of 180 degrees
- Variable speed trigger with safety lock provides manual-like precision and control over the bending speed
- Extremely low profile design (18.4"L x 8.5"H x 9.1"W), yet extremely stable
- Portable design facilitates maneuverability and ease of use

### Capacities

Rebar . . . . . 5/8" (#5) Grade 60

### Specifications

Amps . . . . .	8
Cut Time . . . . .	2.5 sec
Bend Time . . . . .	4.3 sec
Switch . . . . .	Variable Speed
Weight . . . . .	39.7 lbs

### Includes

Deflection Guard . . . . .	320914
Cutter Set (1 pair) . . . . .	319706
D62 Center Roller . . . . .	319714

## CE16SA 16-Gauge Shear



### Features

- Small grip circumference (only 7-1/4" around the barrel) for easy handling and control
- Powerful motor keeps cutting speed consistent even as the load increases
- Lock-on switch for easy and continuous operation
- Reversible blades provide eight cutting edges and require few blade replacements

### Capacities

Aluminum . . . . .	12 ga. (.080")
Mild Steel . . . . .	16 ga. (.060")
Stainless Steel . . . . .	18 ga. (.050")

### Specifications

Amps . . . . .	3.5
No-Load Speed . . . . .	4,700 SPM
Cut Speed . . . . .	20.7 ft/min
Weight . . . . .	3.7 lbs

### Includes

Thickness Gauge . . . . .	949128
3mm Hex Wrench . . . . .	943277

## CN16SA 16-Gauge Sheet Metal Nibbler



### Features

- Smallest grip circumference in its class for comfort and maximum control
- 3-position indexing die holder for quick and easy direction changes
- Downward punching minimizes chips on the work piece
- One-touch, quick-off slide switch for enhanced safety

### Capacities

Aluminum Plate . . . . .	14 ga. (.064")
Mild Steel . . . . .	16 ga. (.060")
Stainless Steel . . . . .	18 ga. (.050")

### Specifications

Amps . . . . .	3.5
No-Load Speed . . . . .	2,300 SPM
Min. Cut Radius . . . . .	1-37/64"
Weight . . . . .	3.5 lbs

### Includes

Punch . . . . .	998030
Die . . . . .	998039
2.5mm Hex Wrench . . . . .	990666
4mm Hex Wrench . . . . .	944458





## FRAMING / STRIP NAILER QUICK REFERENCE

Model	Type	Collation	Fastener Range				Magazine Angle	Magazine Capacity	Tool-Less Depth	Actuation	Weight (lbs)	Page
			Length		Diameter							
			Min	Max	Min	Max						
NR65AK	Pneumatic	Paper	1-1/2"	2-1/2"	.131	.162	36°	44	No	Sequential	6.2	69
NR65AKS	Pneumatic	Paper	1-1/2"	2-1/2"	.131	.162	36°	22	No	Sequential	5.7	69
NR83A2 - NR83A2(Y)	Pneumatic	Plastic	2"	3-1/4"	.113	.131	21°	64-70	Yes	Selective	7.9	65
NR83A2(S) - NR83A2(S1)	Pneumatic	Plastic	2"	3-1/4"	.113	.131	21°	64-70	No	Selective	7.9	65
NR83AA3 - NR83AA3(S)	Pneumatic	Paper	2"	3-1/4"	.113	.131	34°	86	No	Selective	8.4	66
NR90ADPR - NR90AD(S)	Pneumatic	Paper	2"	3-1/2"	.113	.148	35°	86	Yes	Selective	7.0	66
NR90AEPR - NR90AE(S)	Pneumatic	Plastic	2"	3-1/2"	.113	.148	21°	64	Yes	Selective	7.5	65
NR90AF - NR90AF(S)	Pneumatic	Wire	2"	3-1/2"	.113	.131	28°	100	Yes	Selective	7.3	67
NR90GC2	Gas	Paper	2"	3-1/2"	.120	.131	35°	37	No	Sequential	7.7	63
NR90GR2	Gas	Plastic	2"	3-1/2"	.113	.131	21°	32-35	No	Sequential	7.9	63

## COIL NAILER QUICK REFERENCE

Model	Application	Collation	Fastener Range				Magazine Angle	Magazine Capacity	Magazine Loading	Actuation	Weight (lbs)	Page
			Length		Diameter							
			Min	Max	Min	Max						
NV45AB2	Roofing	Wire	7/8"	1-3/4"	-	.120	16°	120	Side	Contact	5.5	67
NV45AB2S	Roofing	Wire	7/8"	1-3/4"	-	.120	16°	120	Bottom	Contact	5.5	67
NV45AE	Roofing	Wire	7/8"	1-3/4"	-	.120	16°	120	Side	Selective	5.5	67
NV45AE2S	Roofing	Wire	7/8"	1-3/4"	-	.120	16°	120	Bottom	Selective	5.5	67
NV50AP3	Plastic/Steel Caps	Wire	7/8"	2"	-	.083	16°	350 Nails /Caps	Side	Selective	5.5	69
NV50AA	Utility Nailer	Plastic	1-1/4"	2"	-	.083	21°	358	Bottom	Contact	4.2	68
NV50A1	Utility Nailer	Wire	1-1/4"	2"	-	.083	16°	400	Bottom	Contact	4.2	68
NV65AH	Siding Nailer	Wire / Plastic	1-1/2"	2-1/2"	.090	.099	16° / 15°	200-300	Bottom	Contact	4.6	68
NV75AG	Siding/Framing	Wire / Plastic	1-3/4"	3"	.090	.131	16° / 15°	200-300	Side	Contact	5.5	68
NV83A2	Framing	Wire	2"	3-1/4"	.099	.131	16°	200-300	Bottom	Contact	8.2	69

## STAPLER QUICK REFERENCE

Model	Staple Crown	Fastener Range			Weight (lbs)	Page
		Min	Max	Ga		
N3804AB3 - N3804AB3(S)	1/4"	1/2"	1-1/2"	18	2.3	72
N5008AC2	7/16"	1"	2"	16	4.4	72
N5010A	1/2"	3/4"	2"	16	4.4	72
N5021A	15/16"	5/8"	2"	16	4.7	73
N5024A2	1"	1"	2"	16	4.7	73

## FLOORING NAILER & STAPLER QUICK REFERENCE

Model	Fastener Type	Fastener Range				Page
		Crown	Min	Max	Ga	
N2503AF	Staple	3/16"	-	1"	20	73
N5009AF	Staple	1/2"	1-1/2"	2"	15-1/2	73
NT50AF	T or L Cleat	n/a	1-3/16"	2"	16	74
NT50AGF	T Cleat	n/a	1-3/16"	2"	16	74
NT50YF	T Cleat	n/a	1-3/16"	2"	16	74

## FINISH NAILER QUICK REFERENCE

Model	Type	Fastener Range			Angle	Page
		Min	Max	Ga		
NP35A	Pneu.	5/8"	1-3/8"	23	Straight	71
NT32AE2 - NT32AE2(S)	Pneu.	5/8"	1-1/4"	18	Straight	71
NT50AE2 - NT50AE2(S)	Pneu.	5/8"	2"	18	Straight	70, 71
NT50GS	Gas	5/8"	2"	18	Straight	64
NT65GS	Gas	1"	2-1/2"	16	Straight	64
NT65M2 - NT65M2(S)	Pneu.	1"	2-1/2"	16	Straight	70
NT65GB	Gas	1-1/4"	2-1/2"	16	20°	64
NT65GA	Gas	1-1/4"	2-1/2"	15	34°	63
NT65MA4 - NT65MA4(S)	Pneu.	1-1/4"	2-1/2"	15	34°	69, 70

## COMPRESSOR QUICK REFERENCE

Model	Type	Motor	Gal	Max PSI	CFM @ 90	Page
EC89	Electric	Induction	4	135	3.0	75
EC12	Electric	Induction	4	135	4.0	75
EC119SA	Electric	Induction	4	135	4.4	75
EC25E	Gas	Honda GX	8	125	9.6	76
EC2510E	Gas	Honda GX	8	145	9.3	76
EC1110	Electric	Induction	5	145	4.4	76

### Specifications

Nail Capacity	37
Magazine Angle	35°
Battery	7.2V NiCd, 1.4 Ah
Battery Life	4,000 Nails
Fuel Cell Life	1,200 Nails
Weight	7.7 lbs

### Includes

1.4Ah NiCd Battery (EB714S)	325292
1 Hour Charger	UC18YGL2
Safety Glasses	875769
Hex Bar Wrench (4mm)	944458
Carrying Case	886146

### Optional

Fuel Cell	728982D
Degreaser/Cleaner	728985B8
Gas Nailer Lubricant	728986B12

### Features

- Operates on fuel rod and cordless battery offering complete portability through elimination of air hose and compressor
- Drives up to 2 nails per second and 1000 nails per hour
- Adjustable depth of drive nose piece assures proper nail down with varying materials

Paper Strip Collation.  
Clipped Head, 35°  
.120 - .131

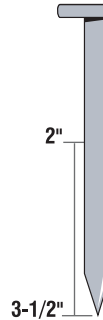

## NR90GC2

3-1/2" Gas Powered Paper Collated Framing Nailer



### Specifications

Nail Capacity	32-35
Magazine Angle	21°
Battery	7.2V NiCd, 1.4 Ah
Battery Life	4,000 Nails
Fuel Cell Life	1,200 Nails
Weight	7.9 lbs

### Includes

1.4Ah NiCd Battery (EB714S)	325292
1 Hour Charger	UC18YGL2
Safety Glasses	875769
Hex Bar Wrench (4mm)	944458
Carrying Case	886146

### Optional

Fuel Cell	728982D
Degreaser/Cleaner	728985B8
Gas Nailer Lubricant	728986B12

### Features

- Operates on fuel rod and cordless battery offering complete portability through elimination of air hose and compressor
- Drives up to 2 nails per second and 1,000 nails per hour
- Adjustable depth of drive nose piece assures proper nail down with varying materials

Plastic Strip Collation  
.113 - .131

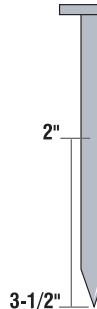

## NR90GR2

3-1/2" Gas Powered Plastic Strip Collated Framing Nailer



### Specifications

Nail Capacity	40
Magazine Angle	Straight
Battery	7.2V NiCd, 1.4 Ah
Battery Life	3,000 Nails
Fuel Cell Life	1,200 Nails
Weight	8.2 lbs

### Includes

1.4Ah NiCd Battery (EB714S)	325292
1 Hour Charger	UC18YGL2
Safety Glasses	875769
Hex Bar Wrench (4mm)	944458
Carrying Case	886485

### Optional

Fuel Cell	728982D
Degreaser/Cleaner	728985B8
Gas Nailer Lubricant	728986B12

### Features

- Operates on fuel rod and cordless battery offering complete portability through elimination of air hose and compressor
- Dry-fire lock out prevents blank drives
- Two-step nail feeder for quick and easy loading

Plastic Strip Collation  
.102

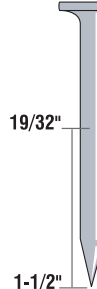

## NC40G

1-1/2" Gas Powered Concrete Nailer



### Specifications

Nail Capacity	100
Magazine Angle	34°
Battery	3.6V Li-Ion 1.5 Ah
Battery Life	2,000 Nails
Fuel Cell Life	1,200 Nails
Weight	4.4 lbs

### Includes

1.5Ah 3.6V Li-Ion Battery (X 2)	326263
AC/DC Charger	UC3SML
No Mar Nose Cap	886349
Safety Glasses	875769
4mm Hex Bar Wrench	944458
3mm Hex Bar Wrench	943277
Carrying Case	886608

### Optional

Fuel Cell	728981
Degreaser/Cleaner	728985B8
Gas Nailer Lubricant	728986B12

### Features

- Operates on fuel rod and cordless battery offering complete portability through elimination of air hose and compressor
- Double action nail feed and reciprocating piston system drive up to 1 nail per second or 900 per hour
- Quick clear nose with tool-less jam release for easy maintenance and reduced downtime

15-Gauge, 34°

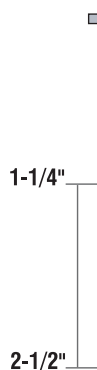

## NT65GA

2-1/2" Gas Powered 15-Gauge Angled Finish Nailer



## NT65GB

2-1/2" Gas Powered 16-Gauge Angled Finish Nailer



### Features

- Operates on fuel rod and cordless battery offering complete portability through elimination of air hose and compressor
- Quick clear nose with tool-less jam release for easy maintenance and reduced downtime
- Tool-less depth of drive adjustment for flush drives into various materials

16-Gauge, 20°

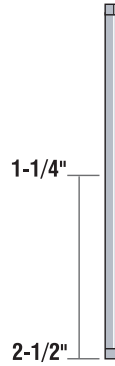

### Specifications

Nail Capacity	100
Magazine Angle	20°
Battery	3.6V Li-Ion 1.5 Ah
Battery Life	2,000 Nails
Fuel Cell Life	1,200 Nails
Weight	4.0 lbs

### Includes

1.5Ah 3.6V Li-ion Battery (X 2)	326263
AC/DC Charger	UC3SML
No Mar Nose Cap	886349
Safety Glasses	875769
4mm Hex Bar Wrench	944458
3mm Hex Bar Wrench	943277
Carrying Case	886608

### Optional

Fuel Cell	728981
Degreaser/Cleaner	728985B8
Gas Nailer Lubricant	728986B12

## NT65GS

2-1/2" Gas Powered 16-Gauge Straight Finish Nailer



### Features

- Operates on fuel rod and cordless battery offering complete portability through elimination of air hose and compressor
- Quick clear nose with tool-less jam release for easy maintenance and reduced downtime
- Tool-less depth of drive adjustment for flush drives into various materials

16-Gauge



### Specifications

Nail Capacity	100
Magazine Angle	Straight
Battery	3.6V Li-Ion 1.5 Ah
Battery Life	2,000 Nails
Fuel Cell Life	1,200 Nails
Weight	4.0 lbs

### Includes

1.5Ah 3.6V Li-ion Battery (X 2)	326263
AC/DC Charger	UC3SML
No Mar Nose Cap	886349
Safety Glasses	875769
4mm Hex Bar Wrench	944458
3mm Hex Bar Wrench	943277
Carrying Case	886348

### Optional

Fuel Cell	728981
Degreaser/Cleaner	728985B8
Gas Nailer Lubricant	728986B12

## NT50GS

2" Gas Powered 18-Gauge Finish Nailer



### Features

- Operates on fuel rod and cordless battery offering complete portability through elimination of air hose and compressor
- Double action nail feed and reciprocating piston system drive up to 2 nails per second or 1,000 per hour
- Quick clear nose with tool-less jam release for easy maintenance and reduced downtime

18-Gauge

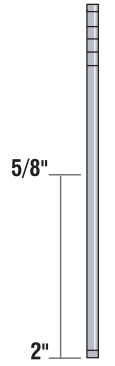

### Specifications

Nail Capacity	100
Magazine Angle	Straight
Battery	3.6V Li-Ion 1.5 Ah
Battery Life	2,000 Nails
Fuel Cell Life	1,200 Nails
Weight	4.0 lbs

### Includes

1.5Ah 3.6V Li-ion Battery (X 2)	326263
AC/DC Charger	UC3SML
No Mar Nose Cap	886846
Safety Glasses	875769
4mm Hex Bar Wrench	944458
3mm Hex Bar Wrench	943277
Carrying Case	886857

### Optional

Fuel Cell	728981
Degreaser/Cleaner	728985B8
Gas Nailer Lubricant	728986B12

## KNR90AE

Round Head Framing Combo Kit



NR90AEPR



EC89 Compressor

### Includes

3-1/2" Plastic Strip Collated Framing Nailer	NR90AEPR
Portable 4 Gal Twin Stack Air Compressor	EC89
25' X 1/4" PVC Air Hose	725969
Safety Glasses	875769
Synthetic Oil (SAE5W 8oz)	192108

### Specifications

Nail Capacity	64-70
Magazine Angle	21°
Air Inlet	3/8"
Operating Pressure	70-120 psi
Weight	7.9 lbs

### Includes

Safety Glasses	875769
----------------	--------

### Optional

Sequential Trip Mechanism	884069
Plastic Case	878898
No Mar Nose Cap	884080

### Features

- Tool-less depth adjustment controls depth of drive
- Lightweight and well-balanced for easy maneuverability
- Open nose design for easy extraction of a jammed nail
- Selective actuation for either sequential or "bump" fire nailing with a simple flip of a switch for tool-less transitions

Plastic Strip Collation

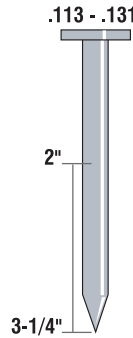

### NR83A2 - NR83A2(S)

3-1/4" Plastic Strip Collated Framing Nailer



NR83A2(S)  
Without Depth Adjustment



### Specifications

Nail Capacity	64-70
Magazine Angle	21°
Air Inlet	3/8"
Operating Pressure	70-120 psi
Weight	7.9 lbs

### Includes

Safety Glasses	875769
----------------	--------

### Optional

Sequential Trip Mechanism	884069
Plastic Case	878898
No Mar Nose Cap	884080

### Features

- Equipped with a new, more secure selective actuation switch
- Tool-less depth adjustment controls depth of drive
- Lightweight and well-balanced for easy maneuverability
- Open nose design for easy extraction of a jammed nail
- Selective actuation for either sequential or "bump" fire nailing with a simple flip of a switch for tool-less transitions

Plastic Strip Collation

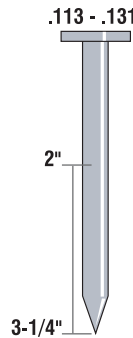

### NR83A2(Y) - NR83A2(S1)

3-1/4" Plastic Strip Collated Framing Nailer



NR83A2(S1)  
Without Depth Adjustment



### Specifications

Nail Capacity	64
Magazine Angle	21°
Air Inlet	3/8"
Operating Pressure	70-120 psi
Weight	7.5 lbs

### Includes

Safety Glasses	875769
----------------	--------

### Optional

Sequential Trip Mechanism	884992
No Mar Nose Cap	886401

### Features

- Lightweight and well-balanced for easy maneuverability
- Tool free depth of drive adjustment to flush drive or countersink into varying material
- Selective actuation for either sequential or "bump" fire nailing with a simple flip of a switch for tool-less transitions

Plastic Strip Collation, 21°

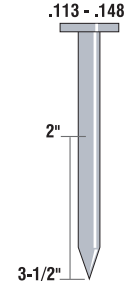

### NR90AEPR

3-1/2" Plastic Strip Collated Framing Nailer



### Specifications

Nail Capacity	64
Magazine Angle	21°
Air Inlet	3/8"
Operating Pressure	70-120 psi
Weight	7.5 lbs

### Includes

Safety Glasses	875769
----------------	--------

### Optional

Sequential Trip Mechanism	884992
No Mar Nose Cap	886401

### Features

- Equipped with a non-slip elastomer grip trigger and ergonomically designed simple flip actuation switch
- Lightweight and well-balanced for easy maneuverability
- Tool free depth of drive adjustment to flush drive or countersink into varying material
- Selective actuation for either sequential or "bump" fire nailing with a simple flip of a switch for tool-less transitions

Plastic Strip Collation, 21°

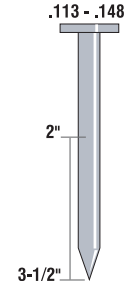

### NR90AE(S)

3-1/2" Plastic Strip Collated Framing Nailer



## NR83AA3

3-1/4" Paper Collated Framing Nailer



### Features

- Driving port suited for a wide range of available nails
- Lightweight and well-balanced for easy maneuverability
- Open nose design for easy extraction of a jammed nail
- Selective actuation for either sequential or "bump" fire nailing with a simple flip of a switch for tool-less transitions

Paper Strip Collation.  
Clipped Head, 34°  
.113 - .131

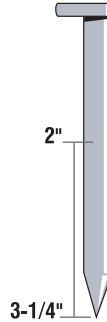

### Specifications

Nail Capacity	86-94
Magazine Angle	34°
Air Inlet	3/8"
Operating Pressure	70-120 psi
Weight	8.4 lbs

### Includes

Safety Glasses	875769
----------------	--------

### Optional

Sequential Trip Mechanism	884069
Nose Cap	882981

## NR83AA3(S)

3-1/4" Paper Collated Framing Nailer



### Features

- Equipped with a new, more secure selective actuation switch
- Driving port suited for a wide range of available nails
- Lightweight and well-balanced for easy maneuverability
- Open nose design for easy extraction of a jammed nail
- Selective actuation for either sequential or "bump" fire nailing with a simple flip of a switch for tool-less transitions

Paper Strip Collation.  
Clipped Head, 34°  
.113 - .131

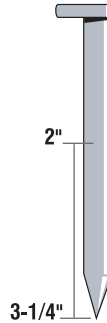

### Specifications

Nail Capacity	86-94
Magazine Angle	34°
Air Inlet	3/8"
Operating Pressure	70-120 psi
Weight	8.4 lbs

### Includes

Safety Glasses	875769
----------------	--------

### Optional

Sequential Trip Mechanism	884069
Nose Cap	882981

## NR90ADPR

3-1/2" Paper Collated Framing Nailer



### Features

- Lightweight and well-balanced for easy maneuverability
- Tool free depth of drive adjustment to flush drive or countersink into varying material
- Selective actuation for either sequential or "bump" fire nailing with a simple flip of a switch for tool-less transitions

Paper Strip Collation  
Clipped Head  
.113 - .148

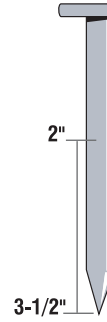

### Specifications

Nail Capacity	50-74
Magazine Angle	35°
Air Inlet	3/8"
Operating Pressure	70-120 psi
Weight	7.0 lbs

### Includes

Safety Glasses	875769
----------------	--------

### Optional

Sequential Trip Mechanism	884992
No Mar Nose Cap	886401

## NR90AD(S)

3-1/2" Paper Collated Framing Nailer



### Features

- Equipped with a non-slip elastomer grip trigger and ergonomically designed simple flip actuation switch
- Lightweight and well-balanced for easy maneuverability
- Tool free depth of drive adjustment to flush drive or countersink into varying material
- Selective actuation for either sequential or "bump" fire nailing with a simple flip of a switch for tool-less transitions

Paper Strip Collation  
Clipped Head  
.113 - .148

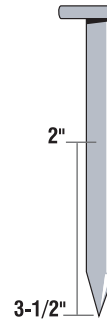

### Specifications

Nail Capacity	50-74
Magazine Angle	35°
Air Inlet	3/8"
Operating Pressure	70-120 psi
Weight	7.0 lbs

### Includes

Safety Glasses	875769
----------------	--------

### Optional

Sequential Trip Mechanism	884992
No Mar Nose Cap	886401

### Specifications

Nail Capacity	100
Magazine Angle	28°
Air Inlet	3/8"
Operating Pressure	70-120 psi
Weight	7.3 lbs

### Includes

Safety Glasses	875769
----------------	--------

### Optional

Sequential Trip Mechanism	886283
No Mar Nose Cap	886401

### Features

- Selective actuation for either sequential or "bump" fire nailing with a simple flip of a switch for tool-less transitions
- Tool-free depth of drive adjustment provides simplicity and flexibility for perfectly flush fastening in various materials
- Open nose design for easy extraction of a jammed nail

Wire Weld Collation,  
Offset Round Head, 28°

.113 - .131



## NR90AF

3-1/2" Wire Weld Framing Nailer



### Specifications

Nail Capacity	100
Magazine Angle	28°
Air Inlet	3/8"
Operating Pressure	70-120 psi
Weight	7.3 lbs

### Includes

Safety Glasses	875769
----------------	--------

### Optional

Sequential Trip Mechanism	886283
No Mar Nose Cap	886401

### Features

- Equipped with a non-slip elastomer grip trigger and ergonomically designed simple flip actuation switch
- Selective actuation for either sequential or "bump" fire nailing with a simple flip of a switch for tool-less transitions
- Tool-free depth of drive adjustment provides simplicity and flexibility for perfectly flush fastening in various materials
- Open nose design for easy extraction of a jammed nail

Wire Weld Collation,  
Offset Round Head, 28°

.113 - .131



## NR90AF(S)

3-1/2" Wire Weld Framing Nailer



### Specifications

Nail Capacity	120
Magazine Angle	16°
Air Inlet	3/8"
Operating Pressure	70-120 psi
Weight	5.5 lbs

### Includes

Safety Glasses	875769
Magazine Shingle Guide Assembly	883370

### Optional

Sequential Trip Mechanism	878226
Power Pack Set	877908

### Features

- Side loading magazine, convenient and easy for quick replenishment
- Tool-less depth of drive adjustment for precision nailing/flush driving
- Carbide tipped push lever reduces wear
- Pneumatic nail feed mechanism powers both the nail advance and return for consistent operation even in the harshest of conditions

Coil, Wire Collation  
.120

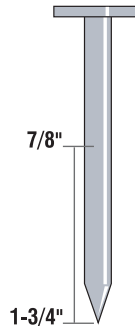

## NV45AB2 - NV45AB2S

1-3/4" Coil Roofing Nailer



NV45AB2S  
Bottom Load Magazine



### Specifications

Nail Capacity	120
Magazine Angle	16°
Air Inlet	3/8"
Operating Pressure	70-120 psi
Weight	5.5 lbs

### Includes

Safety Glasses	875769
Hex Bar Wrench (4mm)	944458
Hex Bar Wrench (5mm)	944459

### Optional

Sequential Trip Mechanism	878226
---------------------------	--------

### Features

- Pneumatic nail feed mechanism powers both the nail advance and return for consistent operation even in the harshest of conditions
- 30% less recoil for optimized kick back to propel nailer across the course
- Improved push lever design has integrated holes to expel excess tar and grime build-up
- Tool-less depth of drive adjustment for precision nailing/flush driving

Coil, Wire Collation  
.120

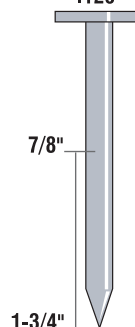

## NV45AE - NV45AES

1-3/4" Coil Roofing Nailer



NV45AES  
Bottom Load Magazine



## NV50AA

2" Light Duty Coil Utility Nailer



### Features

- High capacity canister holds up to 358 nails for less downtime
- Open magazine canister to quickly check nail quantity
- Angled magazine for ease of use in corner applications

Coil, Plastic Collation, 21°

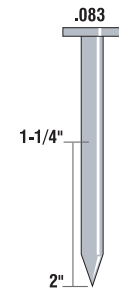

### Specifications

Nail Capacity	358
Magazine Angle	21°
Air Inlet	3/8"
Operating Pressure	70-120 psi
Weight	4.2 lbs

### Includes

Safety Glasses	875769
Hex Bar Wrench (3mm)	943277
Hex Bar Wrench (4mm)	944458

### Optional

Sequential Trip Mechanism	876762
Power Pack Set	877908

## NV50A1

2" Coil Utility Nailer



### Features

- High capacity canister holds up to 400 nails for less downtime
- Open magazine canister to quickly check nail quantity
- Angled magazine for ease of use in corner applications
- Plastic shield deflects wire collation for added safety

Coil, Wire Collation, 16°

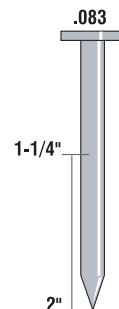

### Specifications

Nail Capacity	400
Magazine Angle	16°
Air Inlet	3/8"
Operating Pressure	70-120 psi
Weight	4.2 lbs

### Includes

Safety Glasses	875769
Hex Bar Wrench (3mm)	943277
Hex Bar Wrench (4mm)	944458

### Optional

Sequential Trip Mechanism	876762
Power Pack Set	877908

## NV65AH

2-1/2" Coil Siding Nailer



### Features

- Drives both wire collated and plastic sheet collated nails for added flexibility
- Tool-less depth of drive adjustment for precision nailing/flush driving
- Plastic shield deflects wire collation for added safety
- Adjustable air deflector directs the air exhaust in any direction

Coil, Wire-16°/Plastic-15° Sheet Collation

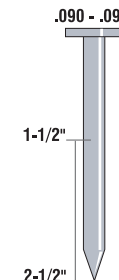

### Specifications

Nail Capacity	200-300
Magazine Angle	16° (Wire) / 15° (Plastic)
Air Inlet	3/8"
Operating Pressure	70-120 psi
Weight	4.6 lbs

### Includes

Safety Glasses	875769
No Mar Nose Cap	878344
Hex Bar Wrench (3mm)	943277
Hex Bar Wrench (4mm)	944458
Hex Bar Wrench (5mm)	944459

### Optional

Sequential Trip Mechanism	881973
Plastic Case	880517

## NV75AG

3" Coil Siding/Framing Nailer



### Features

- Drives both wire collated and plastic sheet collated nails for added flexibility
- Tool-less depth of drive adjustment for precision nailing/flush driving
- Side load magazine to quickly and easily replenish nails
- Plastic shield deflects wire collation for added safety

Coil, Wire-16°/Plastic-15° Sheet Collation

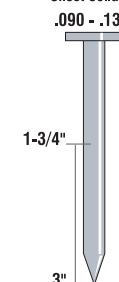

### Specifications

Nail Capacity	200-300
Magazine Angle	16° (Wire) / 15° (Plastic)
Air Inlet	3/8"
Operating Pressure	70-120 psi
Weight	5.5 lbs

### Includes

Safety Glasses	875769
----------------	--------

### Optional

Sequential Trip Mechanism	883991
Plastic Case	883323



### Specifications

Nail Capacity	200-300
Magazine Angle	16°
Air Inlet	3/8"
Operating Pressure	70-120 psi
Weight	8.2 lbs

### Includes

Safety Glasses	875769
----------------	--------

### Optional

Sequential Trip Mechanism	876762
---------------------------	--------

### Features

- Hardened toenail push lever resists wear for prolonged life
- Tool-less depth of drive adjustment for precision nailing/flush driving
- Open nose design for easy extraction of a jammed nail
- Plastic shield deflects wire collation for added safety

Coil, Wire Collation  
.099 - .131

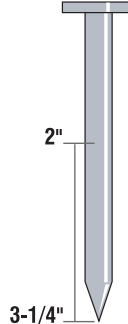

### NV83A2

3-1/4" Coil Framing Nailer



### Specifications

Nail Capacity	44
Nail Capacity (NR65AKS)	22
Magazine Angle	36°
Air Inlet	3/8"
Operating Pressure	80-120 psi
Weight	6.4 lbs
Weight (NR65AKS)	5.7 lbs

### Includes

Safety Glasses	875769
----------------	--------

### Optional

Long Magazine Assembly	883456
Short Magazine Assembly	883469

### Features

- Narrow design for ease of use in tight spaces
- Sequential firing mechanism ensures precision nail placement
- Unique positive safety allows tool to use nails as a guide without damaging collation

Paper Strip Collation, 36°  
.131 - .162

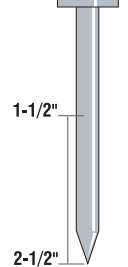

### NR65AK - NR65AKS

2-1/2" Strap-Tite® Fastening System Strip Nailer



STRAP-TITE  
Advanced Fastening System



### Specifications

Nail Capacity	350
Cap Capacity	350
Magazine Angle	16°
Air Inlet	3/8"
Operating Pressure	70-120 psi
Weight	5.5 lbs

### Includes

Safety Glasses	875769
----------------	--------

### Features

- Drives nail and metal or plastic caps in tandem for better hold
- Selective actuation, a simple flip of the switch allows for either sequential or bump fire nailing—no additional parts or tools required
- Tool-free depth adjustment, simple adjustment provides flexibility when fastening various materials

Coil / Wire Collation  
.083

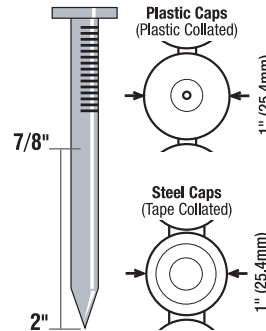

### NV50AP3

2" Coil Cap Nailer



### Specifications

Nail Capacity	100
Magazine Angle	34°
Air Inlet	1/4"
Operating Pressure	70-120 psi
Weight	4.2 lbs

### Includes

Safety Glasses	875769
1/4" NPT Male Plug	190001
No Mar Tip	881751
Carrying Case	884340

### Features

- Integrated air duster button allows air from the compressor to clear away dust and debris from the work surface in preparation for the nail
- Selective actuation switch lets the user easily select bump fire or sequential fire modes
- Tool-less, easy-to-clear nose for quick and simple nail extraction should a nail jam during use
- Depth of drive adjustment for accurate nail depth in varying materials

15-Gauge, 34°

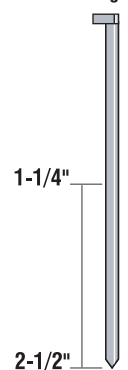

2-1/2" 15-Gauge Angled Finish Nailer with Air Duster



## NT65MA4(S)

2-1/2" 15-Gauge Angled Finish Nailer with Air Duster



### Features

- Equipped with a non-slip elastomer grip trigger and ergonomically designed simple flip actuation switch
- Integrated air duster button allows air from the compressor to clear away dust and debris from the work surface in preparation for the nail
- Selective actuation switch lets the user easily select bump fire or sequential fire modes
- Tool-less, easy-to-clear nose for quick and simple nail extraction should a nail jam during use
- Depth of drive adjustment for accurate nail depth in varying materials

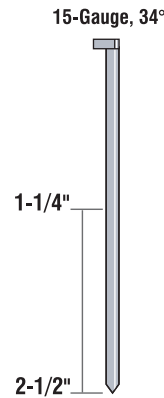

### Specifications

Nail Capacity	100
Magazine Angle	34°
Air Inlet	1/4"
Operating Pressure	70-120 psi
Weight	4.2 lbs

### Includes

Safety Glasses	875769
1/4" NPT Male Plug	190001
No Mar Tip	881751
Carrying Case	884340

## NT65M2

2-1/2" 16-Gauge Finish Nailer with Air Duster



### Features

- Integrated air duster button allows air from the compressor to clear away dust and debris from the work surface in preparation for the nail
- Selective actuation switch lets the user easily select bump fire or sequential fire modes
- Tool-less, easy-to-clear nose for quick and simple nail extraction should a nail jam during use
- Depth of drive dial allows the user to easily adjust the drive depth for a professional finish

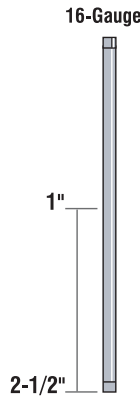

### Specifications

Nail Capacity	100
Magazine Angle	Straight
Air Inlet	1/4"
Operating Pressure	70-120 psi
Weight	3.7 lbs

### Includes

Safety Glasses	875769
1/4" NPT Male Plug	190001
No Mar Tip	881751
Carrying Case	885676

## NT65M2(S)

2-1/2" 16-Gauge Finish Nailer with Air Duster



### Features

- Equipped with a non-slip elastomer grip trigger and ergonomically designed simple flip actuation switch
- Integrated air duster button allows air from the compressor to clear away dust and debris from the work surface in preparation for the nail
- Selective actuation switch lets the user easily select bump fire or sequential fire modes
- Tool-less, easy-to-clear nose for quick and simple nail extraction should a nail jam during use
- Depth of drive dial allows the user to easily adjust the drive depth for a professional finish

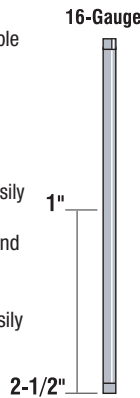

### Specifications

Nail Capacity	100
Magazine Angle	Straight
Air Inlet	1/4"
Operating Pressure	70-120 psi
Weight	3.7 lbs

### Includes

Safety Glasses	875769
1/4" NPT Male Plug	190001
No Mar Tip	881751
Carrying Case	885676

## NT50AE2

2" 18-Gauge Finish Nailer



### Features

- Selective actuation switch lets the user easily select bump fire or sequential fire modes
- Tool-less, easy-to-clear nose for quick and simple nail extraction should a nail jam during use
- Depth of drive dial allows the user to easily adjust the drive depth for a professional finish

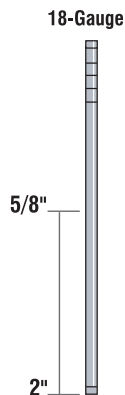

### Specifications

Nail Capacity	100
Magazine Angle	Straight
Air Inlet	1/4"
Operating Pressure	70-120 psi
Weight	2.2 lbs

### Includes

Safety Glasses	875769
1/4" NPT Male Plug	190001
No Mar Tip	885887
Carrying Case	885902

### Specifications

Nail Capacity	100
Magazine Angle	Straight
Air Inlet	1/4"
Operating Pressure	70-120 psi
Weight	2.2 lbs

### Includes

Safety Glasses	875769
1/4" NPT Male Plug	190001
No Mar Tip	885887
Carrying Case	885902

### Features

- Equipped with a non-slip elastomer grip trigger and ergonomically designed simple flip actuation switch
- Selective actuation switch lets the user easily select bump fire or sequential fire modes
- Tool-less, easy-to-clear nose for quick and simple nail extraction should a nail jam during use
- Depth of drive dial allows the user to easily adjust the drive depth for a professional finish

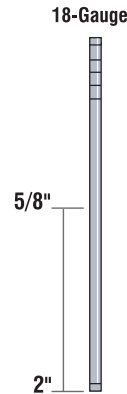

### NT50AE2(S) 2" 18-Gauge Finish Nailer



### Specifications

Nail Capacity	100
Magazine Angle	Straight
Air Inlet	1/4"
Operating Pressure	70-120 psi
Weight	2.0 lbs

### Includes

Safety Glasses	875769
1/4" NPT Male Plug	190001
No Mar Tip	885887
Carrying Case	885902

### Features

- Selective actuation switch lets the user easily select bump fire or sequential fire modes
- Tool-less, easy-to-clear nose for quick and simple nail extraction should a nail jam during use
- Depth of drive dial allows the user to easily adjust the drive depth for a professional finish

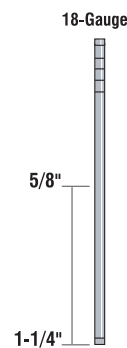

### NT32AE2 1-1/4" 18-Gauge Finish Nailer



### Specifications

Nail Capacity	100
Magazine Angle	Straight
Air Inlet	1/4"
Operating Pressure	70-120 psi
Weight	2.0 lbs

### Includes

Safety Glasses	875769
1/4" NPT Male Plug	190001
No Mar Tip	885887
Carrying Case	885902

### Features

- Equipped with a non-slip elastomer grip trigger and ergonomically designed simple flip actuation switch
- Selective actuation switch lets the user easily select bump fire or sequential fire modes
- Tool-less, easy-to-clear nose for quick and simple nail extraction should a nail jam during use
- Depth of drive dial allows the user to easily adjust the drive depth for a professional finish

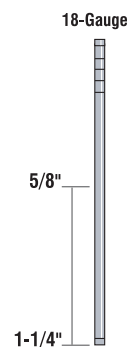

### NT32AE2(S) 1-1/4" 18-Gauge Finish Nailer



### Specifications

Nail Capacity	100
Magazine Angle	Straight
Air Inlet	1/4"
Operating Pressure	65-100 psi
Weight	2.0 lbs

### Includes

Safety Glasses	875769
1/4" NPT Male Plug	190001
No Mar Tip (X 2)	
Hex Bar Wrench	
Carrying Case	887572

### Features

- Large fastener capacity for fewer reloads
- Dual trigger for safe & accurate placement of pins
- Depth of drive adjustment for flush drives into a variety of materials

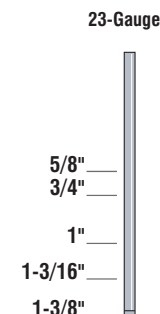

### NP35A 1-3/8" 23-Gauge Pin Nailer



Nailers & Staplers

**UG50Y**  
Digital Laser Meter  
Details on page 24



## N3804AB3

1/4" Narrow Crown Stapler



### Features

- Selective actuation allows transition from single actuation to contact actuation
- Tool free depth adjustment allows for a professional finish with varying materials—simply dial in the desired depth and efficiently finish the job
- Tool-less, easy to clear nose for quick and simple staple extraction

18-Gauge

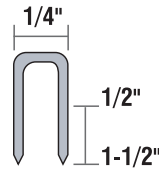

### Specifications

Staple Gauge	18
Staple Capacity	100
Magazine Angle	Straight
Air Inlet	1/4"
Operating Pressure	70-120 psi
Weight	2.3 lbs

### Includes

Safety Glasses	875769
1/4" NPT Male Plug	190001
No Mar Tip	885969
Carrying Case	885902

## N3804AB3(S)

1/4" Narrow Crown Stapler



### Features

- Equipped with a non-slip elastomer grip trigger and ergonomically designed simple flip actuation switch
- Selective actuation allows transition from single actuation to contact actuation
- Tool free depth adjustment allows for a professional finish with varying materials—simply dial in the desired depth and efficiently finish the job
- Tool-less, easy to clear nose for quick and simple staple extraction

18-Gauge

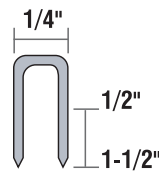

### Specifications

Staple Gauge	18
Staple Capacity	100
Magazine Angle	Straight
Air Inlet	1/4"
Operating Pressure	70-120 psi
Weight	2.3 lbs

### Includes

Safety Glasses	875769
1/4" NPT Male Plug	190001
No Mar Tip	885969
Carrying Case	885902

## N5008AC2

7/16" Standard Crown Stapler



### Features

- High capacity magazine allows for fewer staple replenishments
- Quick-clear jam release increases user efficiency
- Cylinder Valve firing mechanism provides quick response and rapid driving
- Depth of drive adjustment to countersink or flush drive staples

16-Gauge  
7/16"

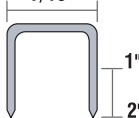

### Specifications

Staple Gauge	16
Staple Capacity	157
Magazine Angle	Straight
Air Inlet	1/4"
Operating Pressure	70-120 psi
Weight	4.4 lbs

### Includes

Safety Glasses	875769
Hex Bar Wrench (4mm)	944458

### Optional

Sequential Trip Mechanism	876762
---------------------------	--------

## N5010A

1/2" Standard Crown Stapler



### Features

- High capacity magazine allows for fewer staple replenishments
- Cylinder valve firing mechanism provides a quick response and powerful driving – up to 3 staples per second
- Depth of drive control for flush drives into various materials
- Tool-less, easy to clear nose for quick and simple staple extraction

16-Gauge  
1/2"

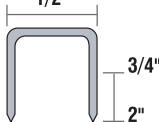

### Specifications

Staple Gauge	16
Staple Capacity	150
Magazine Angle	Straight
Air Inlet	3/8"
Operating Pressure	70-120 psi
Weight	4.4 lbs

### Includes

Safety Glasses	875769
Hex Bar Wrench (4mm)	944458

### Optional

Sequential Trip Mechanism	876762
---------------------------	--------

### Specifications

Staple Gauge	16
Staple Capacity	150
Magazine Angle	Straight
Air Inlet	3/8"
Operating Pressure	70-120 psi
Weight	4.7 lbs

### Includes

Safety Glasses	875769
----------------	--------

### Optional

Sequential Trip Mechanism	876762
---------------------------	--------

### Features

- High capacity magazine allows for fewer staple replenishments
- Cylinder valve firing mechanism provides a quick response and powerful driving – up to 3 staples per second
- Depth of drive control for flush drives into various materials
- Tool-less, easy to clear nose for quick and simple staple extraction

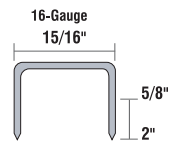

**N5021A**  
15/16" Wide Crown Stapler



### Specifications

Staple Gauge	16
Staple Capacity	157
Magazine Angle	Straight
Air Inlet	1/4"
Operating Pressure	70-120 psi
Weight	4.7 lbs

### Includes

Safety Glasses	875769
----------------	--------

### Optional

Sequential Trip Mechanism	876762
---------------------------	--------

### Features

- High capacity magazine allows for fewer staple replenishments
- Cylinder valve firing mechanism provides a quick response and rapid driving
- Depth of drive control for flush drives into various materials
- Tool-less, easy to clear nose for quick and simple staple extraction

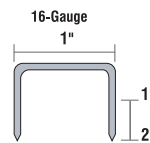

**N5024A2**  
1" Wide Crown Stapler



### Specifications

Staple Gauge	20
Staple Capacity	100
Air Inlet	1/4"
Operating Pressure	70-120 psi
Weight	3.2 lbs

### Includes

Safety Glasses	875769
1/4" NPT Male Plug	190001
Wrench Set (2.5mm, 3mm)	330556
Carrying Case	330555

### Features

- Dual trigger design for comfortable operations when working in a variety of positions
- Tool-free adjustable shoe provides easy adjustments to flooring thicknesses of 1/4" to 7/16"
- Lightweight design allows users to get into tight spaces with ease

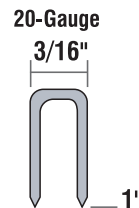

**N2503AF**  
1" Flooring Stapler



### Specifications

Staple Gauge	15-1/2
Staple Capacity	150
Air Inlet	3/8"
Operating Pressure	70-90 psi
Weight	9.1 lbs

### Includes

Safety Glasses	875769
3/8" NPT Male Plug	190051
1/2" Shoe Pad	330387
3/4" Shoe Pad	330381
Non-Marring Hammer	330631
Wrench Set (4mm, 5mm, 6mm, Box)	330386
Carrying Case	330388

### Optional

Prefinished (Wide Profile) Shoe	330389
---------------------------------	--------

### Features

- Mallet activated flooring stapler features a preferred seating system which provides accurate placement of staples at the appropriate angle and depth
- High capacity magazine reduces the frequency of staple re-loads
- High strength aluminum housing reduces overall weight and adds durability

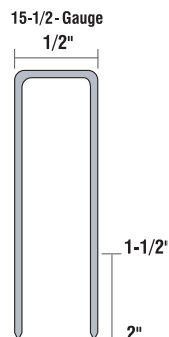

**N5009AF**  
2" Flooring Stapler



## NT50AF

2" Flooring Cleat Nailer



### Features

- Accepts both T & L nails for maximum flexibility
- Mallet activated flooring nailer features a preferred seating system which provides accurate placement of nails at the appropriate angle and depth
- High capacity magazine reduces the frequency of nail re-loads

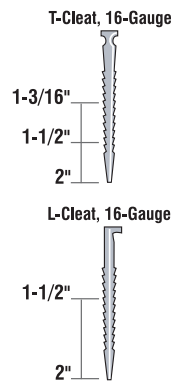

### Specifications

Nail Capacity	150
Nail Type	T or L Nails
Air Inlet	3/8"
Operating Pressure	70-90 psi
Weight	9.0 lbs

### Includes

Safety Glasses	875769
3/8" NPT Male Plug	190051
1/2" Shoe Pad	330387
3/4" Shoe Pad	330381
Non-Marring Hammer	330631
Wrench Set (4mm, 5mm, 6mm, Box)	330386
Carrying Case	330388

### Optional

Prefinished (Wide Profile) Shoe	330389
Nail Set for T and L Nails	330328

## NT50AGF

2" Oil-Less Flooring Cleat Nailer



### Features

- Mallet activated flooring nailer features a preferred seating system which provides accurate placement of staples at the appropriate angle and depth
- Oil-less design provides maintenance free operation
- Converts easily to a face nailer by simply changing the shoe
- Quick release gate allows for easy clearing of jammed fasteners without needing to remove the shoe for added convenience

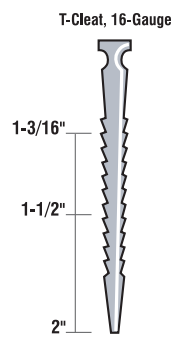

### Specifications

Nail Capacity	175
Nail Type	T Nails
Air Inlet	3/8"
Operating Pressure	90-115 psi
Weight	13.0 lbs

### Includes

Safety Glasses	875769
3/8" NPT Male Plug	190051
Face Nailing Shoe	330438
Face Nailing Shoe Pad	330451
Non-Marring Hammer	330454
Wrench Set	330455
Grease	930035
Carrying Case	330456

### Optional

Shoe Base and Pad - 9/16" Flooring	330458
Shoe Base and Pad - 33/32" Flooring	330459
15-17mm Bamboo Flooring Shoe	330389
Nail Set for T and L Nails	330328

## NT50YF

2" Manual Cleat Nailer



### Features

- Mallet activated flooring nailer features a preferred seating system which provides accurate placement of staples at the appropriate angle and depth
- High strength aluminum housing reduces overall weight and adds durability
- Non-marking accessory shoe prevents damage to the floor
- Ratcheting ram guarantees nails are set

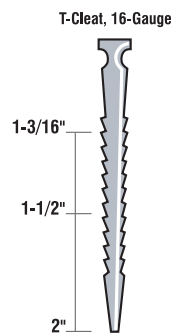

### Specifications

Nail Capacity	150
Nail Type	T Nails
Air Inlet	N/A
Operating Pressure	N/A
Weight	7.6 lbs

### Includes

Safety Glasses	875769
Non-Marring Hammer	330319
Extension Handle	330278
Service Parts Kit	330324
Carrying Case	330325

### Optional

Thin Flooring Shoe (3/8"-9/16")	330318
Face Nailing Shoe	330317
3/8"-3/4" Bamboo Flooring Shoe	330327
Nail Set for T and L Nails	330328
Shim Pack	330629

### Specifications

Power Output	1.3 Run/1.9 Peak HP
Tank Capacity	4 Gallon
Amps	13
Motor RPM	3,450 RPM
Max Pressure	135 PSI
CFM	3.0 @ 90 PSI
Weight	57.7 lbs

### Features

- Direct drive electric motor provides durability and long life
- Overload protection with manual reset
- Line regulator with gauge for immediate use at worksite
- Oil lubricated pump improves efficiency and ensures smooth use

### Includes

Quick Connect Coupler	885447
Synthetic Oil (SAE5W50 8oz)	19210B
Oil Dipstick	881469

### Specifications

Power Output	1.5 Run/2.0 Peak HP
Tank Capacity	4 Gallon
Amps	14.5
Motor RPM	3,450 RPM
Max Pressure	125 PSI
CFM	4.0 @ 90 PSI
Weight	60 lbs

### Features

- Direct drive electric motor provides durability and long life
- Line regulator with gauge for immediate use at worksite
- Oil lubricated pump improves efficiency and ensures smooth use
- All metal inner construction and fan to withstand rugged use

### Includes

Pressure Gauge	881508
Synthetic Oil (SAE5W50 8oz)	19210B
Oil Dipstick	881469

### Specifications

Power Output	1.6 Run/2.5 Peak HP
Tank Capacity	4 Gallon
Amps	15
Motor RPM	3,450 RPM
Max Pressure	135 PSI
CFM	4.4 @ 90 PSI
Weight	63.7 lbs

### Features

- Oil lubricated pump utilizes oversized bearings for quiet and dependable service
- Locking regulator and 105 on/135 off psi means no worries about pressure wander or pressure starved tools on the job
- Custom integrated control panel protects the gauge, regulator and plumbing, while centralizing controls for ease of use

### Includes

Industrial Couplers (X 2)	191171
Synthetic Oil (SAE5W50 8oz)	19210B
Oil Dipstick	881469

### EC89

Portable 4 Gallon Twin Stack Air Compressor



### EC12

Portable 4 Gallon Twin Stack Air Compressor



### EC119SA

Portable 4 Gallon Twin Stack Air Compressor



## EC2510E

8 Gallon Gas Powered Wheeled Air Compressor



### Features

- Powered by a professional grade Honda GX engine
- Solid cast iron cylinder provides industry recognized premium material for long life, consistent compression and low oil carryover
- Oversized oil level site glass allows everyone to monitor the oil level for the pump avoiding pump damage due to lock up from inadequate oil supply

\* The power rating of the engine indicated in this document is the net power output tested on a production engine for the engine model and measured in accordance with SAE J1349 at a specified rpm. Mass production engines may vary from this value. Actual power output for the engine installed in the final machine will vary depending on numerous factors, including the operating speed of the engine in application, environmental conditions, maintenance, and other variables.

### Specifications

Power Output	..... 5.5 Net HP* @ 3,600 RPM
Tank Capacity	..... 8 Gallon
Displacement	..... 196 cc
Motor RPM	..... 3,200 RPM
Max Pressure	..... 145 PSI
CFM	..... 9.3 @ 90 PSI
Weight	..... 144 lbs

### Includes

Synthetic Oil (SAE5W50 8oz)	..... 19210B
Breather Pipe Plug	..... 885483
Wheel	..... 885423
Pressure Gauge	..... 885446
Drive Belt	..... 885444
Filter	..... 881553

## EC25E

8 Gallon Gas Powered Wheeled Air Compressor



### Features

- Powered by a professional grade Honda GX engine
- Cast iron pump with oil splash lubrication and ball bearing mounted crank shaft for durability
- 10" fly cooling wheel, coupled with a shroud to direct air over compressor coils, allows continuous use without the threat of overheating
- Belt drive lowers pump RPM for longer life

\* The power rating of the engine indicated in this document is the net power output tested on a production engine for the engine model and measured in accordance with SAE J1349 at a specified rpm. Mass production engines may vary from this value. Actual power output for the engine installed in the final machine will vary depending on numerous factors, including the operating speed of the engine in application, environmental conditions, maintenance, and other variables.

### Specifications

Power Output	..... 6.5 Net HP* @ 3,600 RPM
Tank Capacity	..... 8 Gallon
Displacement	..... 196 cc
Motor RPM	..... 1,380 RPM
Max Pressure	..... 125 PSI
CFM	..... 9.6 @ 90 PSI
Weight	..... 170 lbs

### Includes

Synthetic Oil (SAE5W50 8oz)	..... 19210B
Oil Dipstick	..... 724119
Intake Filter	..... 724044
Wheel	..... 724005
Pressure Gauge	..... 724088
Drive Belt	..... 724050
Regulator	..... 724065

## EC1110

5-Gallon Wheelbarrow Air Compressor



### Features

- Two air outlets
- Retractable handles
- Integrated control panel
- Easy to start at low voltage supply
- Oil lubricated pump

### Specifications

Power Output	..... 1.6 Run HP
Tank Capacity	..... 5 Gallon
Amps	..... 15
Motor RPM	..... 3,450 RPM
Max Pressure	..... 145 PSI
CFM	..... 4.2 @ 90 PSI
Weight	..... 90 lbs

### Includes

Synthetic Oil (SAE5W50 8oz)	..... 19210B
Oil Dipstick	..... 881460



Item Code	Description	M's Box	M's Ctn.	Ctns/Skid	Wt/lbs/Skid	Item Code	Description	M's Box	M's Ctn.	Ctns/Skid	Wt/lbs/Skid
<b>NR83A, NR83A2, NR90AC, NR90AC2, NR90AC3, NR90GR, NR90GR2, NR90AE</b>						<b>NR83A, NR83A2, NR90AC, NR90AC2, NR90AC3, NR90GR, NR90GR2, NR90AE</b>					
Full Round Head Brite Basic Plastic Strip Framing Nails						Full Round Head Heat Treated Plastic Strip Nails					
10100	2" x .113 SM		6	48	1810	10199	2-1/4" x .120 SM		5	48	1950
10122	2" x .113 RG		6	48	1810	10198	2-1/4" x .120 SC		5	48	1950
10102	2-3/8" x .113 SM		5	48	1860	<b>NR83A, NR83A2, NR83A2(S), NR90AC, NR90AC2, NR90AC3, NR90GR, NR90GR2, NR90AE</b>					
10102M	2-3/8" x .113 SM BS FRH		2	48		Full Round Electro Galvanized Plastic Strip Ballistic Fasteners					
10103	2-3/8" x .113 RG		5	48	1860	17640	8 x 1-3/4" Threaded SC EG	1	4	48	1235
10103M	2-3/8" x .113 RG BS FRH		2	48		17641	8 x 2" Threaded SC EG	1	4	48	1430
10203	2-3/8" x .113 SC		5	48	1860	17644	8 x 2-1/4" Threaded SC EG	1	4	48	1530
10105	3" x .120 SM		4	48	2005	17642	8 x 2-1/2" Threaded SC EG	1	4	48	1715
10133	3" x .120 RG		4	48	2005	17643	8 x 2-3/4" Threaded SC EG	1	4	48	1910
10124	3" x .120 SC		4	48	2003	17645	8 x 3" Threaded SC EG	1	4	48	2005
10107	3-1/4" x .120 SM		4	48	2195	<b>N3804AB, N3804AB2, N3804AB3</b>					
10132	2-1/2" x .131 SM		5	48	2435	18 Gauge Electro Galvanized Finish Staples					
10132M	2-1/2" x .131 SM BS FRH		2	48		11099S	1/4" x 1/2" - 18 GA EG	5	50	69	
10131	2-1/2" x .131 RG		5	48	2435	11100S	1/4" x 5/8" 18 GA EG	5	50	60	
10110	3" x .131 SM		4	48	2340	11101S	1/4" x 3/4" - 18 GA EG	5	30	84	
10110M	3" x .131 SM BS FRH		2	28		11102S	1/4" x 7/8" - 18 GA EG	5	50	44	
10186	3" x .131 RG		4	48	2340	11103S	1/4" x 1" - 18 GA EG	5	30	69	
10111	3-1/4" x .131 SM		4	48	2535	21103S	1/4" x 1" - 18 GA EG	1	10	150	
10111M	3-1/4" x .131 SM BS FRH		2	48		11104S	1/4" x 1-1/8" - 18 GA EG	5	30	60	
10109	3-1/4" x .131 SC		4	48	2535	11105S	1/4" x 1-1/4" - 18 GA EG	5	50	36	
10120	3-1/2" x .131 SM		4	48	2580	11107S	1/4" x 1-1/2" - 18 GA EG	5	30	48	
10000	1-1/2" x .148 SM		5	48	2100	<b>N5008AA, N5008AB, N5008AC, N5008AC2</b>					
10143M	2-3/8" x .148 SM BS FRH		2	48		16 Gauge Standard Crown Staples					
10136	3" x .148 SM		4	48	2970	11200	7/16" x 1"		10	60	1115
10138M	3-1/4" x .148 SM BS FRH		2	48		11201	7/16" x 1-1/4"		10	60	1386
10140	3-1/2" x .162 SM		3	48	3110	11203	7/16" x 1-1/2"		10	60	1655
<b>NR83A, NR83A2, NR90AC, NR90AC2, NR90AC3, NR90GR, NR90GR2, NR90AE</b>						<b>NR824A, N5024A, N5024A2</b>					
Full Round Head Electro Galvanized Plastic Strip Framing Nails						16 Gauge Roofing Staples					
10123	2" x .113 RG		6	48	1810	11300	1" x 5/8"		10	60	1086
10104	2-3/8" x .113 SM		5	48	1860	11301	1" x 7/8"		10	60	1235
10112	2-3/8" x .113 RG		5	48	1860	11305	1" x 3/4"		10	60	1175
10113	3" x .120 SM		4	48	2005	11302	1" x 1"		10	60	1355
10117	3" x .120 RG		4	48	2005	11303	1" x 1-1/4"		10	60	1655
10106	3" x .120 SC		4	48	2005	11304	1" x 1-1/2"		10	60	1895
10114	3-1/4" x .120 SM		4	48	2195	<b>OTHER BRANDS</b>					
10119	3-1/4" x .120 SC		4	48	2195	Medium Crown and Wide Crown Staples					
10155	2-1/2" x .131 SM		5	48	2435	11403	1" x 1-1/4" 16 GA GS Paslode Style		10	60	1690
10115	3" x .131 SM		4	48	2340	11404	1" x 1-1/2" 16 GA GS Paslode Style		10	60	1835
10116	3-1/4" x .131 SM		4	48	2535	11506	1/2" x 1-1/4" 16 GA GS Paslode Style		10	60	1355
<b>NR83A, NR83A2, NR90AC, NR90AC2, NR90AC3, NR90GR, NR90GR2, NR90AE</b>						Wire Coil Electro Galvanized Roofing Nails					
Full Round Head Hot Dipped Galvanized Plastic Strip Framing Nails						12100 1" x .120 SM 7.2 48 1335					
10171M	2" x .113 RG HDG FRH		2	48		12101 1-1/4" x .120 SM 7.2 48 1575					
10159	2-3/8" x .113 SC DP HDG-FRH		5	48		12102 1-1/2" x .120 SM 7.2 40 1515					
10160	2-3/8" x .113 SM HDG FRH		5	48		12103 1-3/4" x .120 SM 7.2 40 1755					
10161	2-3/8" x .113 RG HDG FRH		5	48		<b>NV45AB, NV45AB2, NV45AB2S, NV45AC, NV45AE, NV45AES</b>					
10161M	2-3/8" x .113 RG HDG FRH		2	48		Wire Coil Electro Galvanized Roofing Nails					
20161S	2-3/8" x .113 RG HDG FRH	1	4	48		12100 1" x .120 SM 7.2 48 1335					
10162	3" x .131 SM HDG FRH		4	48		12101 1-1/4" x .120 SM 7.2 48 1575					
10162M	3" x .131 SM HDG FRH		2	48		12102 1-1/2" x .120 SM 7.2 40 1515					
10163	3-1/4" x .131 SM HDG FRH		4	48		12103 1-3/4" x .120 SM 7.2 40 1755					
10163M	3-1/4" x .131 SM HDG FRH		2	48		<b>NV45AB, NV45AB2, NV45AB2S, NV45AC, NV45AE, NV45AES</b>					
10164	3-1/2" x .131 SM HDG FRH		4	48		Wire Coil Stainless Steel Roofing Nails					
10165	3" x .120 SC DP HDG FRH		4	48		12120 1-1/4" x .120 SM 304 SS 7.2 48 1650					
10165M	3" x .120 SC DP HDG FRH		2	48		<b>NV83A, NV83A2, NV65AC</b>					
10166	3-1/4" x .120 SC DP HDG FRH		4	48		Full Round Head Brite Basic Wire Coil Framing Nails					
10166M	3-1/4" x .120 SC DP HDG FRH		2	48		12200 2" x .099 SM 9 40 1835					
10168	2-1/2" x .131 SM HDG FRH		4	48		12201 2" x .099 RG 9 40 1835					
10300	3" x .120 SM HDG FRH		4	48		12205 2" x .099 SC BL CHS 9 40 1835					
10301	2-1/4" x .148 SM HDG FRH		4	48		12206 2-1/4" x .099 SC BL CHS 9 40 1955					
10302	3" x .120 RG HDG FRH		4	48		12219 2-3/8" x .099 RG 9 40 2005					
10302M	3" x .120 RG HDG FRH		2	48		12218 2-1/2" x .099 SC BL CHS 9 40 2075					
20302S	3" x .120 RG HDG FRH	1	4	48		12203 2" x .113 SM 5 56 1775					
10303	3-1/2" x .162 SM HDG FRH		3	48		12226 2" x .113 RG 5 56 1775					
10305	3-1/4" x .148 SM HDG FRH		3	48		12221 2-3/8" x .113 SM 5 48 1860					
10306	3-1/4" x .131 SC HDG FRH		4	48		12211 2-3/8" x .113 RG 5 48 1860					
10307	2-3/8" x .148 SM HDG FRH		4	48		12213 3" x .120 SM 4 45 1925					
10308	3" x .131 SM 304 SS FRH		4	48		12231 3" x .120 SC 4 45 1925					
10309	3-1/4" x .120 RG HDG FRH		4	48		12215 3-1/4" x .120 SM 4 45 2000					
10309M	3-1/4" x .120 RG HDG FRH		2	48		12214 3-1/4" x .120 SC 4 45 2000					
<b>NR83A, NR83A2, NR90AC, NR90AC2, NR90AC3, NR90GR, NR90GR2, NR90AE</b>						12236 2-1/2" x .131 SM 4.5 48 2000					
Full Round Head 304 Stainless Steel Plastic Strip Framing Nails						12236H 2-1/2" x .131 SM BS FRH 2.4 72					
10150	2-3/8" x .113 RG 304 SS		1	5	48	1860	12216 3" x .131 SM 4 45 2240				
10152	3" x .131 RG 304 SS		1	4	48	2340	12216H 3" x .131 SM BS FRH 2.4 60				
10153	3-1/4" x .120 RG 304 SS		1	4	48	2195	12217 3-1/4" x .131 SM 4 45 2330				
<b>NR83A, NR83A2, NR90AC, NR90AC2, NR90AC3, NR90GR, NR90GR2, NR90AE</b>						12217H 3-1/4" x .131 SM BS FRH 2.4 60					
Full Round Head Hot Dipped Galvanized Plastic Strip Fiber Cement Nails											
10172	2-5/8" x .113 SM		5	48	1960						
10174	2-1/2" x .113 SM		5	48	2100						
10173	3" x .120 SM		4	48	2195						

Item Code	Description	M's Box	M's Ctn.	Ctns/Skid	Wt/lbs/Skid	Item Code	Description	M's Box	M's Ctn.	Ctns/Skid	Wt/lbs/Skid	
<b>NV83A, NV83A2, NV65AC</b>												
Full Round Head Electro Galvanized Wire Coil Framing Nails												
12202	2" x .099 RG		9	40	1585							
12207	2-3/8" x .099 RG		9	40	2075			2.8	75	1150		
12227	2" x .113 RG		5	56	1705	12344	1-1/4" x .083 RG	2.8	75	1250		
12228	2-3/8" x .113 RG		5	48	1860	12345	2" x .083 RG	2.8	75	1400		
12235	3" x .120 RG		4	45	1920	<b>NV65AC</b>						
12232	3" x .120 SC		4	45	1920	Plastic Sheet Concrete Coil Nails						
12220	3-1/4" x .120 SM		4	45	2000	CV3838	1-1/2" x .150 SM	0.54	2.16	30	680	
12222	3-1/4" x .120 SC		4	45	2000	CV3850	2" x .150 SM	0.54	2.16	30	875	
12237	2-1/2" x .131 SM		4	48	2000	CV3865	2-1/2" x .150 SM	0.54	2.16	30	1085	
12233	2-1/2" x .131 RG		4.5	48	2000	<b>VH650</b>						
12229	3" x .131 SM		4	45	2070	Electro Galvanize Plastic Coil Nails						
12230	3-1/4" x .131 SM		4	45	2330	13260	1-7/8" x .086 SM		9	30	895	
<b>NV83A, NV83A2, NV65AC</b>												
Full Round Head Hot Dipped Galvanized Wire Coil Framing Nails												
12700	2" x .099 RG		5	48	1915	13261	1-7/8" x .086 RG		9	30	895	
12701	2-3/8" x .099 RG		5	48	1525	13262	2-1/4" x .092 SM		7.2	30	1014	
12703	2" x .113 RG		4	48	1605	13263	2-1/4" x .092 RG		7.2	30	1014	
12705	2-3/8" x .113 RG		4	48	1955	<b>VH650</b>						
12705H	2-3/8" x .113 RG HDG FRH		2.7	72		Brite Basic Plastic Coil Nails						
12707	3" x .120 RG		4	45	2015	13280	2" x .086 SM		7.2	30	820	
12707H	3" x .120 RG HDG FRH		2.4	60		<b>NV65AH, NV75AG</b>						
12708	3" x .120 SC		4	45	2015	Plastic Sheet Aluminum Coil Nails						
12709	3-1/4" x .120 SM		4	45	2150	13310	1-7/8" x .092 RG		6	30	335	
12710	3-1/4" x .120 SC		4	45	2150	<b>NV65AH, NV75AG</b>						
12711	2-1/2" x .131 SM		4	48	2005	Plastic Sheet Electro Galvanized Coil Nails						
12712	2-1/2" x .131 RG		4	48	2005	13304	1-3/4" x .086 RG		6	30	650	
12713	3" x .131 SM		4	45	2240	13313	2" x .092 RG		6	30	845	
12714	3-1/4" x .131 SM		4	45	2510	13321	2-1/4" x .092 SM		4.8	30	755	
12714H	3-1/4" x .131 SM HDG FRH		2.4	60		13320	2-1/4" x .092 RG		4.8	30	755	
<b>NV83A, NV83A2, NV65AC</b>												
Heat Treated Brite Basic Coil Nails												
12400	1-1/2" x .099 SM HT		4.5	48	870	13306	1-7/8" x .099 SM		6	30	838	
12400H	1-1/2" x .099 SM BS HT FRH		3	96		13307	1-7/8" x .099 RG		6	30	850	
12406	2-1/4" x .099 SM HT		4.5	48	1205	13326	2" x .099 SM		6	30	877	
12406H	2-1/4" x .099 SM HT BS FRH		3	72		<b>NV65AH, NV75AG</b>						
12407	2-1/4" x .099 SC HT		4.5	48	1205	Plastic Sheet Hot Dipped Galvanized Coil Nails						
12410	1-1/2" x .113 SM HT		4.5	48	1105	13305	1-3/4" x .086 RG		6	30	755	
12416	2-1/4" x .113 SM HT		4.5	48	1540	13316	2" x .092 RG		6	30	845	
<b>NV83A, NV83A2, NV65AC</b>												
Full Round Head Stainless Steel Wire Coil Nails												
12600	2" x .099 RG 304 SS		9	40	1583	13328	2-1/4" x .092 SM		4.8	30	755	
12601	2-3/8" x .099 RG 304 SS		5	40	2485	13325	2-1/4" x .092 RG		4.8	30	755	
12604	2" x .113 RG 304 SS		5	48	1830	13331	2-1/2" x .092 SM		4.8	30	816	
12605	2-3/8" x .113 RG 304 SS		5	48	1860	13330	2-1/2" x .092 RG		4.8	30	816	
12605S	2-3/8" x .113 RG SS304		1	120		<b>NV65AH, NV75AG</b>						
12607	3" x .120 RG 304 SS		4	45	1925	Plastic Sheet Hot Dipped Galvanized Coil Fiber Cement Nails						
12608	3" x .120 SC 304 SS		4	45	1925	13375	2" x .092 SM		6	30	965	
12609	3-1/4" x .120 SM 304 SS		4	45	2060	13376	2" x .092 RG		6	30	965	
12610	3-1/4" x .120 SC 304 SS		4	45	2060	13388	2-1/4" x .092 SM		4.8	30	755	
12603	2-3/8" x .131 RG 304 SS		5	48	3240	13385	2-1/4" x .092 RG		4.8	30	755	
12611	2-1/2" x .131 SM 304 SS		4	45	1910	13389	2-1/2" x .092 SM		4.8	30	845	
12612	2-1/2" x .131 RG 304 SS		4	45	1910	13390	2-1/2" x .092 RG		4.8	30	845	
12613	3" x .131 SM 304 SS		4	45	2150	13391	3" x .113 SM		4.8	30	912	
12606	3" x .131 RG 304 SS		4	45	2150	<b>NV65AH, NV65AHS, NV75AG</b>						
12614	3-1/4" x .131 SM 304 SS		4	45	2420	Hot Dipped Galvanized Wire Coil Siding Nails						
12615	3-1/4" x .131 RG 304 SS		4	45	2420	13363	1-3/4" x .092 RG		3.6	60	995	
<b>NV50A1 &amp; NV50AE</b>												
Brite Basic Mini Wire Coil Nails												
12301	1-1/4" x .083 RG		16	40	1435	13364	2" x .092 SM		3.6	60	1115	
12305	1-1/2" x .083 SM		16	40	1634	13365	2" x .092 RG		3.6	60	1115	
12306	1-1/2" x .083 RG		16	40	1634	13366	2-1/4" x .092 SM		3.6	60	1235	
12311	1-3/4" x .083 RG		16	40	1875	13367	2-1/4" x .092 RG		3.6	60	1235	
12315	2" x .083 SM		12	40	1595	13369	2-1/2" x .092 RG		3.6	60	1415	
12316	2" x .083 RG		12	40	1595	<b>NV65AH, NV75AG</b>						
<b>NV50A1 &amp; NV50AE</b>												
Electro Galvanized Mini Wire Coil Nails												
12302	1-1/4" x .083 RG		16	40	1397	Plastic Sheet Stainless Steel Coil Fiber Cement Nails						
12307	1-1/2" x .083 RG		16	40	1634	13386	2-1/4" x .092 SM 304 SS		2.4	4.8	30	785
12312	1-3/4" x .083 RG		16	40	1907	13387	2-1/4" x .092 RG 304 SS		2.4	4.8	30	785
12317	2" x .083 RG		12	40	1599	<b>NV65AH, NV75AG</b>						
<b>NV50A1 &amp; NV50AE</b>												
Stainless Steel Mini Wire Coil Nails												
12322	1-1/2" x .083 RG 304 SS		5.6	36	560	Electro Galvanized Wire Coil Siding Nails						
12320	1-3/4" x .083 RG 304 SS		5.6	36	648	13334	1-3/4" x .092 RG		3.6	60	875	
12321	2" x .083 RG 304 SS		5.6	36	710	13333	2" x .092 SM		3.6	60	1055	
<b>NV50AP2, NV50AP3</b>												
Plasti-Cap Electro Galvanized Wire Coil Nails												
12359	7/8" x .083 RG		2.8	75	805	13335	2" x .092 RG		3.6	60	1055	
12343	1-1/4" x .083 RG		2.8	75	860	13339	2-1/4" x .092 SM		3.6	60	1175	
12358	2" x .083 RG		2.8	75	1060	13338	2-1/4" x .092 RG		3.6	60	1175	
						13340	2-1/2" x .092 RG		3.6	60	1295	

Item Code	Description	M's Box	M's Ctn.	Ctns/Skid	Wt/lbs/Skid	Item Code	Description	M's Box	M's Ctn.	Ctns/Skid	Wt/lbs/Skid
<b>NT45A, NT50AD, NT32AE, NT50AE, NT32AE2, NT50AE2</b>						<b>NR83AA, NR83AA2, NR90AA, NR83AA3, NR90AD, NR90GC, NR90GC2</b>					
18 Gauge Electro Galvanized Brad Nails						Hot Dipped Galvanized Clipped Head Paper Tape Framing Nails					
14100S	5/8" x 18 GA EG	5	100	48		15132	2-3/8" x .120 SM	4.8	80	2637	
14101S	3/4" x 18 GA EG	1	10	400		15133	2-3/8" x .120 RG	4.8	80	3155	
14102S	1" x 18 GA EG	5	100	48		25133S	2-3/8" x .120 RG HDG CLH	1	4	72	
14105S	1-3/4" x 18 GA EG	5	100	24		15136	3" x .120 SM	2.5	84	2191	
14106S	1-1/4" x 18 GA EG	5	100	24		15137	3" x .120 RG	2.5	84	2191	
14107S	1-1/2" x 18GA EG	5	50	48		25137S	3" x .120 RG HDG CLH	1	4	72	
14108S	2" x 18 GA EG	5	50	48		15140	3-1/4" x .120 SM	2.5	84	2359	
<b>NT65A, NT65A2, NT65A3, NT65M, NT65M2</b>						<b>NR65AK, NR65AKS</b>					
16 Gauge Finish Nails						Heat Treated Brite Basic Paper Tape Strap Tite Nails					
14200	1"	5	60	48	2485	15141	3-1/4" x .120 RG	2.5	84	2359	
14201	1-1/4"	5	40	48	2195	15138	3" x .131 SM	2.5	84	2470	
14202	1-1/2"	2.5	30	48	1955	15139	3" x .131 RG	2.5	84	2725	
14203	1-3/4"	2.5	30	48	2295	15142	3-1/4" x .131 SM	2.5	84	2849	
14204	2"	2.5	30	48	2435	15143	3-1/4" x .131 RG	2.5	84	2849	
14206	2-1/2"	2.5	20	48	2150	15144	3-1/2" x .131 SM	2.5	84	2849	
<b>NT65GB</b>						<b>NR65AK, NR65AKS</b>					
16 Gauge Galvanized Angle Finish Nails						Heat Treated Brite Basic Paper Tape Strap Tite Nails					
14412	1-1/4"	2	12	126		17121	1-1/2" x .131 SM	4	96	2630	
14413	1-1/2"	2	12	126		17124	1-1/2" x .148 SM	3	96	2535	
14414	1-3/4"	2	12	105		17126	2-1/2" x .131 SM	2.5	96	2535	
14415	2"	2	12	105		17127	2-1/2" x .148 SM	2.5	96	3205	
14418	2-1/2"	2	12	84		17130	2-1/2" x .162 SM	2	96	3110	
<b>NT65AA, NT65MA, NT65MA2, NT65MA3, NT65MA4</b>						<b>NR65AK, NR65AKS</b>					
15 Gauge Angled Finish Nails						Heat Treated Hot Dipped Galvanized Paper Tape Strap Tite Nails					
14302	1-1/4"	4	16	80	2035	17131	1-1/2" x .131 SM	4	96	2630	
14303	1-1/2"	4	16	80	2515	17134	1-1/2" x .148 SM	3	96	2535	
14304	1-3/4"	4	16	60	2075	17136	2-1/2" x .131 SM	2.5	96	2535	
14305	2"	4	16	60	2435	17137	2-1/2" x .148 SM	2.5	96	3205	
14306	2-1/4"	4	16	60	2675	17140	2-1/2" x .162 SM	2	96	3110	
14308	2-1/2"	3	12	60	2255	<b>NR65AK, NR65AKS</b>					
14307	2-1/2" 14 GA	3	12	60	2615	316 Stainless Steel Paper Tape Strap Tite Nails					
<b>NT65AA, NT65MA, NT65MA2, NT65MA3, NT65MA4</b>						<b>NR65AK, NR65AKS</b>					
15 Gauge Electro Galvanized Angled Finish Nails						316 Stainless Steel Paper Tape Strap Tite Nails					
24201S	1-1/4" x 15 GA EG	1	10	105		17151	1-1/2" x .131 SM	0.5	4	80	2115
14313	1-1/2"	4	16	60	1895	17154	1-1/2" x .148 SM	0.5	3	80	1955
24202S	1-1/2" x 15 GA EG	1	10	105		17156	2-1/2" x .131 SM	0.5	2.5	80	2115
24203S	1-3/4" x 15 GA EG	1	10	104		17157	2-1/2" x .148 SM	0.5	2.5	64	2085
14315	2"	4	16	60	2375	17160	2-1/2" x .162 SM	0.5	2	64	2020
24204S	2" x 15 GA EG	1	10	104		<b>NP35A</b>					
14318	2-1/2"	3	12	60	2315	23 Gauge Headless Pins					
24206S	2-1/2" x 15 GA EG	1	10	78		23000	5/8" x 23 GA Galv	2	120		
<b>NT65AA, NT65MA, NT65MA2, NT65MA3, NT65MA4</b>						<b>NT50AF, NT50AGF, NT50YF</b>					
15 Gauge Stainless Steel Angled Finish Nails						15 Gauge Flooring T-Cleat					
14334	2" 304 SS	4	16	60	2058	42629H	2" FLOOR T-CLEAT NAIL	1	10	62	
14335	2-1/4" 304 SS	4	16	60	2288	42640H	1-1/2" FLOOR T-CLEAT NAIL	1	5	144	
14336	2-1/2" 304 SS	3	12	60	2538	42646H	1-3/16" FLOOR T-CLEAT NAIL	1	5	144	
<b>NR90AF</b>						<b>NT50AF</b>					
Offset Round Head 28", Wire Weld, Basic						15 Gauge Flooring L-Cleat					
28002	2-3/8" x .113 SM		2	100		04702H	2" FLOOR L-CLEAT NAIL	1	5	128	
28003	2-3/8" x .113 RG		2	100		04704H	1-1/2" FLOOR L-CLEAT NAIL	1	5	128	
28008	3" x .120 SM		2	100		<b>N5009AF</b>					
28012	3-1/4" x .120 SM		2	100		15 Gauge Flooring Staple					
28016	3-1/2" x .131 SM		2	100		04722H	2" 15Ga FLOOR STAPLE	7.7	60		
<b>NR83AA, NR83AA2, NR90AA, NR83AA3, NR90AD, NR90GC, NR90GC2</b>						<b>04724H</b>					
Clipped Head Paper Tape Framing Nails						1-1/2" 15Ga FLOOR STAPLE					
15116	2" x .120 RG		4.8	80	2637	<b>N2503AF</b>					
15100	2-3/8" x .120 SM		4.8	80	3139	20 Gauge Flooring Staple					
15101	2-3/8" x .120 RG		4.8	80	3139	47592H	1" 20Ga FLOOR STAPLE	5	50	96	
15105	3" x .120 SM		2.5	84	2191						
15125	3" x .120 RG		2.5	84	2191						
15107	3-1/4" x .120 SM		2.5	84	2359						
15115	3-1/4" x .120 RG		2.5	84	2359						
15109	3" x .131 SM		2.5	84	2470						
15110	3-1/4" x .131 SM		2.5	84	2725						
15126	3-1/2" x .131 SM		2.5	84	2849						
<b>NR83AA, NR83AA2, NR90AA, NR83AA3, NR90AD, NR90GC, NR90GC2</b>											
Electro Galvanized Clipped Head Paper Tape Framing Nails											
15121	2-3/8" x .120 RG		4.8	80	3155						
15124	3" x .120 RG		2.5	84	2191						
15120	3" x .131 SM		2.5	84	2475						
15119	3-1/4" x .131 SM		2.5	84	2725						

## CHAIN SAW QUICK REFERENCE

Model	Type	Displacement cc	Engine Type	Bar Length	Optional Bar Lengths	Fuel Capacity fl. oz.	Starting System	Weight (lbs)	Page
CS33ET14	Top Handle	32.3	PureFire® Two-Stroke	14"	12"	11.2	S-Start	9.1	81
CS33EB16	Rear Handle	32.2	PureFire® Two-Stroke	16"	12", 14"	11.8	S-Start	8.6	81
CS40EA18	Rear Handle	39.6	PureFire® Two-Stroke	18"	14", 16"	12.8	S-Start	9.9	81
CS51EAP20	Rear Handle	50.1	PureFire® Two-Stroke	20"	18"	17.6	Standard	11.5	81

## GRASS TRIMMER / BRUSHCUTTER QUICK REFERENCE

Model	Type	Displacement cc	Engine Type	Shaft Length	Drive Shaft	Fuel Capacity fl. oz.	Starting System	Cutting Head	Weight (lbs)*	Page
CG22EABSLP	Curved	21.1	PureFire® Two-Stroke	54"	6mm Flex Cable	14.9	S-Start	4" Semi-Auto	10.1	82
CG22EASSLP	Straight	21.1	PureFire® Two-Stroke	60"	7mm Solid Steel	14.9	S-Start	4" Semi-Auto	11.0	82
CG22EADSLP	Split	21.1	PureFire® Two-Stroke	60"	7mm Solid Steel	14.9	S-Start	4" Semi-Auto	11.5	84
CG24EKSL	Straight	23.9	PureFire® Two-Stroke	60"	7mm Solid Steel	17.5	Standard	5" Semi-Auto	12.5	82
CG24EASPSL	Straight	23.9	PureFire® Two-Stroke	60"	7mm Solid Steel	17.6	S-Start	4" Semi-Auto	11.7	82
CG27EASPSL	Straight	26.9	PureFire® Two-Stroke	60"	7mm Solid Steel	17.6	S-Start	4" Semi-Auto	11.8	83
CG18DSDL	Straight	18V	Disc Motor	52"	Direct Drive	3.0Ah	Electric	4" Semi-Auto	9.5	83

\* Fully Assembled

## Specifications

Engine Type	2-Stroke
Displacement	32.3 cc
Fuel Tank Capacity	11.2 fl oz
Oil Tank Capacity	6.4 fl oz
Bar & Chain	Oregon® (Sprocket Nose)
Optional Bar Length	12"
Pitch	3/8" (Low Profile)
CARB Tier III Compliant	Yes
Dry Weight	9.1 lbs (Powerhead Only)

## Includes

Combi Box Spanner (10/19mm)	6685402
14" Chain Cover	6685439
14" Oregon Bar and Chain (assembled)	

## Optional

12" Bar/Chain 3/8" Sprocket Nose	6685294
Spike Set	6696329

## Features

- Features PureFire low emission 2-stroke engine technology
- Anti-vibration system increases comfort to get more done with less fatigue
- 14" Oregon bar and chain reduces kickback and provides excellent cutting performance
- Fuel primer bulb, auto-return choke and pull-force reduction result in quick and easy starts
- Side access chain tensioner provides quick and convenient chain adjustment
- Two bar mounting studs keep the chain at peak cutting efficiency
- Ideal for tree pruning with a top handle design that provides excellent balance and maneuverability
- Inertia activated chain break stops chain rotation for improved safety

**CS33ET14**  
14" Top Handle Chain Saw, 32.3 cc



## Specifications

Engine Type	2-Stroke
Displacement	32.2 cc
Fuel Tank Capacity	11.8 fl oz
Oil Tank Capacity	8.5 fl oz
Bar & Chain	Oregon®
Optional Bar Length	12", 14"
Pitch	3/8" (Low Profile)
CARB Tier III Compliant	Yes
Dry Weight	8.6 lbs (Powerhead Only)

## Includes

Combi Box Spanner (10/19mm)	6685402
16" Chain Cover	6685440
16" Oregon Bar and Chain (assembled)	

## Optional

12" Bar/Chain 3/8" Sprocket	6685294
14" Bar/Chain 3/8" Sprocket	6685295
Spike Set	6696329

## Features

- Features PureFire low emission 2-stroke engine technology
- Five point anti-vibration system provides maximum comfort to get more done with less fatigue
- 16" Oregon bar and chain reduces kickback and provides excellent cutting performance
- Inertia activated chain break stops chain rotation for improved safety
- Outstanding power-to-weight reduces fatigue resulting in higher productivity
- Side access chain tensioner provides for quick and easy chain adjustment
- Two bar mounting studs keep the chain at peak cutting efficiency
- Purge prime bulb for easy and reliable starts

**CS33EB16**  
16" Rear Handle Chain Saw, 32.2 cc



## Specifications

Engine Type	2-Stroke
Displacement	39.6 cc
Fuel Tank Capacity	12.8 fl oz
Oil Tank Capacity	8.1 fl oz
Bar & Chain	Oregon® (Sprocket Nose)
Optional Bar Length	14", 16"
Pitch	.325"
CARB Tier III Compliant	Yes
Dry Weight	9.9 lbs (Powerhead Only)

## Includes

Combi Box Spanner (10/19mm)	6685402
18" Chain Cover	
18" Oregon Bar and Chain (assembled)	

## Optional

14" Bar/Chain 3/8" Sprocket	6685295
16" Bar/Chain 3/8" Sprocket	6696520
Spike Set	6696329

## Features

- Features PureFire low emission 2-stroke engine technology
- S-Start pull-force reduction system and purge primer bulb gives quick and easy starts
- 18" Oregon bar and chain reduces kickback and provides excellent cutting performance
- Vibration dampening system for user comfort and less fatigue
- Side access chain tensioner provides quick and convenient chain adjustment
- Two bar mounting studs keep the chain at peak cutting efficiency
- Inertia activated chain brake stops chain rotation for improved safety
- Outstanding power to weight reduces fatigue resulting in higher productivity

**CS40EA18**  
18" Rear Handle Chain Saw, 39.6 cc



## Specifications

Engine Type	2-Stroke
Displacement	50.1 cc
Fuel Tank Capacity	17.6 fl oz
Oil Tank Capacity	9.1 fl oz
Bar & Chain	Oregon® (Sprocket Nose)
Optional Bar Length	18"
Pitch	.325"
CARB Tier III Compliant	Yes
Dry Weight	11.5 lbs (Powerhead Only)

## Includes

Combi Box Spanner (10/19mm)	6685402
20" Chain Cover	
20" Oregon Bar and Chain (assembled)	

## Optional

18" Bar/Chain 3/8" Sprocket	
Spike Set	6696329

## Features

- Features PureFire low emission 2-stroke engine technology
- Decompression valve reduces recoil pull force for easy starting
- 20" Oregon bar and chain reduces kickback and provides excellent cutting performance
- Vibration dampening system for user comfort and less fatigue
- Side access chain tensioner provides quick and convenient chain adjustment
- Two bar mounting studs keep the chain at peak cutting efficiency
- Inertia activated chain brake stops chain rotation for improved safety
- Outstanding power to weight reduces fatigue resulting in higher productivity

**CS51EAP20**  
20" Rear Handle Chain Saw, 50.1 cc



## CG22EABSLP

21.1 cc Curved Shaft Grass Trimmer



### Features

- Features PureFire low emission 2-stroke engine technology
- S-Start effortless & reliable starting system reduces the amount of pull force by 50%
- Anti-vibration system provides maximum comfort to get more done with less fatigue
- 4" semi-automatic trimmer head provides hassle-free operation and holds 13 feet of .095" co-polymer cutting line
- 54" drive shaft helps reduce fatigue
- Lightweight & well-balanced for ease of use and maneuverability
- Protective cover shields fuel tank from wear and tear

### Specifications

Engine Type	2-Stroke
Displacement	21.1 cc
Fuel Tank Capacity	14.9 fl oz
Starting System	S-Start
Drive Shaft	6mm Flex Cable
Drive Shaft Length	54"
Cutting Head	4" Semi-Automatic
CARB Tier III Compliant	Yes
Dry Weight	10.1 lbs (Fully Assembled)

### Includes

Box Wrench (Hex. Socket 17/19)	6684764
Hex Bar Wrench (4mm)	944458
Safety Glasses	875769

## CG22EASSLP

21.1 cc Straight Shaft Grass Trimmer



### Features

- Features PureFire low emission 2-stroke engine technology
- Extra long 60" solid steel drive shaft for maximum cutting performance and extended reach
- S-Start effortless & reliable starting system reduces the amount of pull force by 50%
- Anti-vibration system provides maximum comfort to get more done with less fatigue
- 4" semi-automatic trimmer head provides hassle-free operation and holds 13 feet of .095" co-polymer cutting line
- Lightweight & well-balanced for ease of use and maneuverability
- Protective cover shields the fuel tank from wear and tear

### Specifications

Engine Type	2-Stroke
Displacement	21.1 cc
Fuel Tank Capacity	14.9 fl oz
Starting System	S-Start
Drive Shaft	7mm Solid Steel
Drive Shaft Length	60"
Cutting Head	4" Semi-Automatic
CARB Tier III Compliant	Yes
Dry Weight	11.0 lbs (Fully Assembled)

### Includes

Box Wrench (Hex. Socket 17/19)	6684764
Hex Bar Wrench (4mm)	944458
Safety Glasses	875769

## CG24EKSL

23.9 cc Straight Shaft Grass Trimmer



### Features

- Features PureFire low emission 2-stroke engine technology
- Honeycomb design outer engine housing provides added engine protection for maximum durability
- Extra long 60" solid steel drive shaft for maximum cutting performance and extended reach
- Professional grade dual-line trimmer head holds 25 feet of line for more productivity
- Lightweight and well-balanced for ease of use and maneuverability
- Protective cover shields the fuel tank from wear and tear
- Blade capable (sold separately) to tackle thick brush and weeds with ease
- Anti-vibration system provides maximum comfort to get more done with less fatigue
- Extra large fuel tank results in extended use

### Specifications

Engine Type	2-Stroke
Displacement	23.9 cc
Fuel Tank Capacity	17.5 fl oz
Starting System	Standard Recoil
Drive Shaft	7mm Solid Steel
Drive Shaft Length	60"
Cutting Head	5" Semi-Automatic
CARB Tier III Compliant	Yes
Dry Weight	12.5 lbs (Fully Assembled)

### Includes

Box Wrench (Hex. Socket 17/19)	6684764
Hex Bar Wrench (4mm)	944458
Safety Glasses	875769

## CG24EASPSL

23.9 cc Straight Shaft Grass Trimmer



### Features

- Features PureFire low emission 2-stroke engine technology
- Extra long 60" solid steel shaft for maximum cutting performance and extended reach
- S-Start effortless & reliable starting system reduces pull force up to 50%
- Anti-vibration system to maximize comfort and productivity with less fatigue
- 4" semi-automatic trimmer head for hassle free operation and easy loading
- Protective cover shields the fuel tank from wear and tear
- Blade capable (not included) for clearing thick brush and weeds

### Specifications

Engine Type	2-Stroke
Displacement	23.9 cc
Fuel Tank Capacity	17.6 fl oz
Starting System	S-Start
Drive Shaft	7mm Solid Steel
Drive Shaft Length	60"
Cutting Head	4" Semi-Automatic
CARB Tier III Compliant	Yes
Dry Weight	11.7 lbs (Fully Assembled)

### Includes

Box Wrench (Hex. Socket 17/19)	6684764
Hex Bar Wrench (4mm)	944458
Safety Glasses	875769

## PureFire® 2-Stroke Engines

Hitachi's PureFire series achieve lower emissions and lower fuel consumption, moreover less CO<sub>2</sub> exhausted compared with our traditional engine products. They are environmentally friendly and healthy, suitable for prolonged use.



**2-STROKE ENGINE FOR MEETING EMISSIONS STANDARDS**



### EMISSIONS DURABILITY PERIOD (EDP\*)

Most Hitachi PureFire® Engines are rated to 300 hour EDP as indicated by the icon.

\* EDP is defined by the U.S. Environmental Protection Agency as "Emissions Durability Period." EPA uses the term "useful life", which is defined as "...when engine performance depreciates to the point where usefulness and/or reliability is impacted to a degree sufficient to necessitate overhaul or replacement..." (U.S. Government, Code of Federal Regulations, Vol. 40, Chapter 1, Sec. 90.105, par. , §ii).

#### Specifications

Engine Type	2-Stroke
Displacement	26.9 cc
Fuel Tank Capacity	17.6 fl oz
Starting System	S-Start
Drive Shaft	7mm Solid Steel
Drive Shaft Length	60"
Cutting Head	4" Semi-Automatic
CARB Tier III Compliant	Yes
Dry Weight	11.8 lbs (Fully Assembled)

#### Features

- Features PureFire low emission 2-stroke engine technology
- Extra long 60" solid steel shaft for maximum cutting performance and extended reach
- S-Start effortless & reliable starting system reduces pull force up to 50%
- Anti-vibration system with padded handle to maximize comfort and productivity with less fatigue
- 4" semi-automatic trimmer head for hassle free operation and easy loading
- Protective cover shields the fuel tank from wear and tear
- Blade capable (not included) for clearing thick brush and weeds

#### Includes

Box Wrench (Hex. Socket 17/19)	6684764
Hex Bar Wrench (4mm)	944458
Safety Glasses	875769

#### Specifications

Engine Type	Disc Motor
Volts	18
Starting System	Electric
Drive Shaft	Direct Drive
Cutting Head	4" Semi-Automatic
Battery Amp Hour	3.0
Battery Type	Lithium Ion Slide
CARB Tier III Compliant	Yes (Emission Free)
Dry Weight	9.5 lbs (Fully Assembled)

#### Features

- Features Hitachi Disc Motor technology with motor located at trimmer head
- 52 inch straight shaft for maximum cutting performance and reach
- Hitachi High Capacity 18V, 3.0Ah Li-ion battery and charger
- Extremely low 69 dbA sound level compared to 95 dbA of gas trimmers
- Sealed, dust proof and water resistant motor
- Lightweight, low vibration and well balanced for comfort and productivity
- Compatible with Hitachi 18V slide battery power tools
- Zero emission trimmer

#### Includes

3.0Ah 18V Li-Ion Slide Battery BSL1830 (X 1)	330067
14.4V- 18V LI Universal Battery Charger	UC18YGSL
Safety Glasses	875769

#### CG27EASPSL

26.9 cc Straight Shaft Grass Trimmer



#### CG18DSDL

18V Lithium Ion Grass Trimmer (3.0Ah)

*Lithium-ion*

zero emission

DISC MOTOR



## CG22EADSLP

21.1 cc Split Shaft Grass Trimmer



### Features

- Features PureFire low emission 2-stroke engine technology
- Quickly and easily converts to one of four optional Hitachi attachments (edger tool, articulating hedge trimmer tool, pole saw tool and mini-cultivator)
- S-Start effortless and reliable starting system reduces the amount of pull force by 50%
- Anti-vibration system provides maximum comfort to get more done with less fatigue
- 4" semi-automatic trimmer head provides hassle-free operation and holds 13 feet of .095" co-polymer cutting line
- Lightweight & well-balanced for ease of use and maneuverability
- Protective cover shields the fuel tank from wear and tear

### Specifications

Engine Type	2-Stroke
Displacement	21.1 cc
Fuel Tank Capacity	14.9 fl oz
Starting System	S-Start
Drive Shaft	7mm Solid Steel
Drive Shaft Length	60"
Cutting Head	4" Semi-Automatic
CARB Tier III Compliant	Yes
Dry Weight	11.5 lbs (Fully Assembled)

### Includes

Box Wrench (Hex. Socket 17/19)	6684764
Shoulder Belt Single	6696448
Hex Bar Wrench (4mm)	944458
Safety Glasses	875769

### Optional

Articulating Hedge Trimmer Attachment	CGHT
Mini-Cultivator Attachment	CGMC
Portable Edger Attachment	CGPE
Pole Saw Attachment	CGPS

## CGHT

Articulating Hedge Trimmer Attachment



## CGMC

Mini-Cultivator Attachment



### Features

- Articulates up to 135 Degrees
- Great for Tall Hedges or Tough Ground Cover

### Specifications

Drive Shaft	7mm Solid Steel
Articulating Blade Angle Range	0-135°
Blade Length	21.6"
Blade Type	Double-sided, dual reciprocating
Overall Length	56"
Weight	5.3 lbs

### Features

- 2.6" Digging Depth
- 5.8" Digging Width

### Specifications

Drive Shaft	7mm Solid Steel
Digging Depth	2.6"
Digging Width	5.8"
Teeth	12 Times
Overall Length	34"
Weight	6.1 lbs

## CGPE

Portable Edger Attachment



## CGPS

Pole Saw Attachment



### Features

- Height Adjustment System

### Specifications

Drive Shaft	Heavy-Duty, 8 Layer Cable
Cutting Depth	2.6"
Cutting Blade Length	7.8"
Wheel	5.9" Solid Rubber
Overall Length	33"
Weight	4.6 lbs

### Features

- 10" Oregon® Bar and Chain
- Cuts Branches up to 8" in Diameter

### Specifications

Drive Shaft	7mm Solid Steel
Bar & Chain	Oregon® 10"
Oil Capacity	5.4 fl. oz.
Max Branch Diameter	8"
Oiling System	Crankshaft Driven, Adjustable, Automatic
Overall Length	57"
Weight	3.7 lbs



### Specifications

Engine Type	2-Stroke
Displacement	23.9 cc
Fuel Tank Capacity	17.6 fl oz
Air Volume	441 CFM
Air Velocity	170 MPH
CARB Tier III Compliant	Yes
Dimensions (W x H)	8-5/64" x 13-25/64"
Dry Weight	8.6 lbs

### Features

- Lightweight (only 8.6 lbs) & well-balanced for comfortable use and less fatigue
- Class leading air volume at 441 CFM for excellent debris movement
- Produces an impressive air velocity of 170 MPH (with taper nozzle)
- Large two-finger throttle lever for easier operation
- Features PureFire low emission 2-stroke engine technology for a better environment
- Auto-return stop switch automatically resets to the ON position for easier starting

### RB24EAP 23.9 cc Handheld Blower



### Specifications

Max Power Output	4,300W
Rated Power Output	3,800W
Engine Type	Honda GX
Max Current @ 120V	35.8 Amps
Max Current @ 240V	17.9 Amps
Starting System	Recoil
Fuel Tank Capacity	5 Gallons
Dry Weight	157 lbs

### Features

- Maintenance-free, brushless alternator provides consistent, dependable power with no maintenance
- Integrating a cart with oversized tires into the design of the generator maximizes portability allowing for single person transport
- A safe worksite is the first priority and the GFCI outlets allow for safe operation in outdoor environments
- The 120V, 30 Amp twist lock outlet provides flexibility, while avoiding interrupted power supply
- Moving the generator with on-site equipment is convenient and safe with the included lift hook

### E43 8 HP 4,300 Watt Generator



### Includes

Tank Cap	683726
Fuel Filter	683728
Wheel (X 2)	683751

Accessories



## Saw Blade Information Guide

### Tooth Geometry

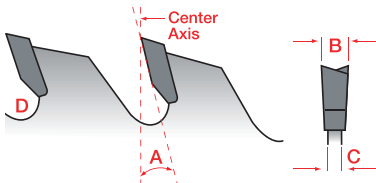

- Hook (A)** Angle of tooth relative to blade radius, which determines aggressiveness of cut and workpiece finish.
- Kerf (B)** Carbide tooth width. Thin kerf blades are useful for low powered (1-1/2 HP and down) saws in rip cuts, and for larger blades in crosscuts.
- Plate (C)** Blade body thickness varies from 0.031" to 0.098". Thicker plates need more power than thinner plates and are more stable; therefore have less vibration.
- Gullet (D)** Cutaway area between teeth for efficient chip removal.

### Grind Configuration: Shape and pattern of teeth, which determines application and performance

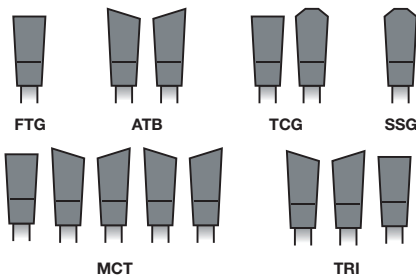

Grind Type	Primary Application
Flat Top Grind (FTG)	Ripping, grooving and joints
Alternate Top Bevel (ATB)	Crosscutting, cutoff and trim of wood & plywood
Triple Chip Grind (TCG)	Hardwood, non-ferrous metals, plastics
Solid Surface Grind (SSG)	Optimized for clean cuts and long life in dense synthetic materials
Multi-Purpose Carbide Tip (MCT)	Combination tooth grind. Ripping and crosscutting of wood and composites.
Tri-Grind (TRI)	Combined ATB and FTG - Fast, clean rip and crosscuts.

## Circular Saw Blades

### Shock Resistant Brazing and Aggressive Hook Angle

Extremely durable brazing of carbide tips allows the tips to withstand shocking impact for maximum durability, fast cuts and long-lasting performance.



### Precision Ground Ultra Thin Kerf Teeth

Hitachi's kerf thickness allows for tight, clean, precise and fast cuts.



### Industrial High Performance Micrograin Carbide

Micrograin structure provides extreme impact resistance, durability and longevity.

### Diamond Knockout Arbor

Precision punched arbor insures rotation accuracy and less vibration which prolongs life of the blade and allows use of blade on both circular and worm drive saws.

### Premium Steel Plate

Thin and strong high grade precision pressed HRC41-49 plate keeps blade flat and true for long lasting performance.

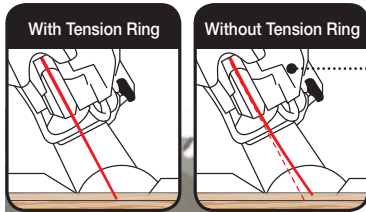

## Miter & Table Saw Blades

### Precision Balancing and Tensioning

Adds strength, stiffness and stability to the blade and gives the blade the capability to withstand heat and side loads without warping or deflection.



### Tri-Metal Shock Resistant Brazing

Brazing the carbide tips with three metals allows the tips to withstand extreme impact for maximum durability.



### Precision Ground Thin Kerf Teeth

Hitachi's kerf thickness allows for tight, clean, precise and fast cuts.



### Industrial High Performance Selected Micrograin Carbide

Micrograin structure provides extreme impact resistance, durability and longevity.



### Laser Cut Sound Damping Channels

Allows the blade to expand during heat build-up, keeping the cut true and straight.



### Premium Laser Cut Steel Plate

Thin and strong high grade laser cut HRC44 plate keeps blade flat and true for long lasting performance.



## Metal Cutting Blades



### Selected Micrograin Carbide Tip

Specially formulated C-6 carbide grade resist breakage on impact and lasts much longer than standard carbides.

### Hand Balancing and Tensioning

Individually hand hammer tensioned plates for true and flat blade body assures proper balancing with tolerance for run-out.

### Unique Triple Chip Grind Tooth Configuration

Specially designed tooth geometry delivers smooth low resistance and faster cuts. Reduces spark production and eliminates abrasive wheel dust.

### Unique inserted Tooth Design with Chip Limiting Steel Support

Special tooth geometry with "inserted" tooth design greatly improves efficiency, durability and security of the tip. High quality cuts without the clouds of dust and scorch marks associated with friction blades. Cool cuts leave the work piece edge with fewer burrs than other brands.

### Cost Effective

Reduced cost-per-cut by maximized operator performance as a result of fewer blade changes.

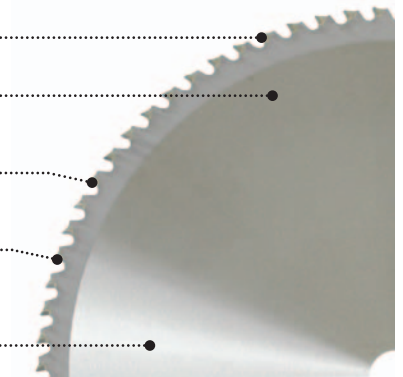

## Fiber Cement Blades

### Polycrystalline Diamond Teeth (PCD)

Proprietary PCD technology creates a tooth with more durability and longer cutting life than other diamond or carbide tipped blades.



### Tri-Metal Shock Resistant Brazing

Brazing the carbide tips with three metals allows the tips to withstand extreme impact for maximum durability.



### Premium Laser Cut Solid Steel Plate

Thin, strong grade laser cut HRC 44 plate keeps blade flat and true for long lasting high performance. No vent design insures a reduction in dust.



### Exclusive Kerf, Gullet and Radial Clearance Configuration

Allows for fast, clean gang cuts on up to five pieces of fiber cement planks in one pass.

### Thin Kerf Positive Hook Angle Design

Insures high quality cutting, a longer blade life.

### Exclusive PCD Tooth Configuration

Allows high level dust reduction.

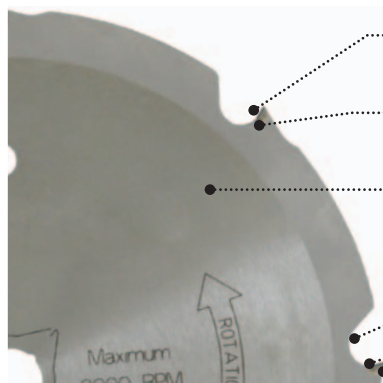

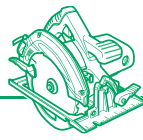

Accessories



## Fiber Cement

**Cross Cut and Sizing:** Crosscutting and ripping of fiber cement board, siding and trim.  
**Finish and Trim:** Sizing and Trim with clean finish cut of fiber cement board, siding and trim.

Part No.	Diameter	Arbor	Teeth	Grind	Hook	Kerf	Plate	Carbide Grade	# of Blades
<b>Cross Cut and Sizing</b>									
18008	7-1/4"	5/8" <>	4	FLAT	12°	.087"	.063"	Diamond	1
18008B	7-1/4"	5/8" <>	4	FLAT	12°	.087"	.063"	Diamond	12



## Combination Framing and Ripping

Ideal for framing, ripping and cross cutting in all woods, nail embedded wood, wood composites or plywood. Thin kerf and small number of teeth deliver fast, rapid, smooth cuts. Most popular all-purpose blade type for house framing when ultra smooth finish is not necessary.

Part No.	Diameter	Arbor	Teeth	Grind	Hook	Kerf	Carbide Grade	# of Blades
725205	6-1/2"	5/8"	24	ATB	20°	.071"	C25 micrograin	1
725212B10	7-1/4"	5/8" <>	24	ATB	20°	.071"	C25 micrograin	10
725212B50	7-1/4"	5/8" <>	24	ATB	20°	.071"	C25 micrograin	50
725213B10	7-1/4"	5/8" <>	24	ATB Hollow	20°	.071"	C25 micrograin	10
725213B50	7-1/4"	5/8" <>	24	ATB Hollow	20°	.071"	C25 micrograin	50
725215B50	7-1/4"	5/8" <>	24	Hollow	20°	.071"	C25 micrograin	50
303358	8-1/4"	5/8" <>	20	ATB	20°	.087"	C25 micrograin	1



## Finish and Trim

Sand-free cross grain cutting and trimming of all woods, plywood, paneling and OSB with a clean finish cut

Part No.	Diameter	Arbor	Teeth	Grind	Hook	Kerf	Carbide Grade	# of Blades
317451	6-1/2"	5/8"	40	ATB	20°	.071"	C25 micrograin	1
303682	7-1/4"	5/8" <>	40	ATB	20°	.071"	C25 micrograin	1



## Pressure Treated and Wet Lumber

Ideal for framing, decking, ripping and cross cutting in pressure treated and wet lumber. Anti-heat Urethane Coating reduces friction, prevents gum build-up and improves cutting speed

Part No.	Diameter	Arbor	Teeth	Grind	Hook	Kerf	Carbide Grade	# of Blades
320843B10	7-1/4"	5/8" <>	24	ATB	20°	.071"	C25 micrograin	10
320843B50	7-1/4"	5/8" <>	24	ATB	20°	.071"	C25 micrograin	50



## Ultra Thin Kerf for Cordless

Ultra Thin Kerf provides faster cut, decreases friction and prolongs the life of the battery.

Part No.	Diameter	Arbor	Teeth	Grind	Hook	Kerf	Carbide Grade	# of Blades
725211B10	7-1/4"	5/8" <>	24	ATB	20°	.051"	C25 micrograin	10
725211B50	7-1/4"	5/8" <>	24	ATB	20°	.051"	C25 micrograin	50



## Steel Saw Blades

Combination general purpose blade for smooth and fast cross cutting, ripping and miter.

Part No.	Diameter	Arbor	Teeth	Kerf	Description	# of Blades
725216B50	7-1/4"	5/8" <>	140	Hollow Ground	Plywood Laminate	50



## Ferrous Metals

Clean, fast cutting of mild steel: Angle, Pipe and Tubing with "dry cut" low RPM miter and cut-off saws. Uniquely designed tooth geometry produces a clean, burr-free cut. Specially formulated carbide provides long life, resists breakage on impact and lasts longer than standard carbide blades and abrasive discs

Part No.	Diameter	Arbor	Teeth	Grind	Carbide Grade	# of Blades
726111	7-1/4"	5/8" <>	48	TCG	C6 carbide	1

\* <> Indicates Diamond Knock Out

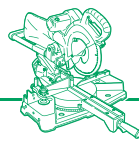

## Fiber Cement

Ripping, crosscutting and miter of fiber cement board, siding and trim.

Part No.	Diameter	Arbor	Teeth	Grind	Hook	Kerf	Plate	Carbide Grade	# of Blades
18108	10"	5/8"	6	FLAT	12°	.087"	.063"	Diamond	1
18109	12"	1"	8	FLAT	12°	.087"	.063"	Diamond	1



## Combination Framing and Ripping

Fast ripping in plywood, wood composites and natural wood.

Part No.	Diameter	Arbor	Teeth	Grind	Hook	Kerf	Carbide Grade	# of Blades
998840	8-1/2"	5/8"	24	ATB	15°	.087"	C2 micrograin	1
311128	10"	5/8"	24	ATB	18°	.098"	C2 micrograin	1
310878	10"	5/8"	40	ATB	5°	.098"	C2 micrograin	1
974651	15"	1"	50	ATB	0°	.110"	C2 micrograin	1



## Finish and Trim

Ultra Fine smooth finish for decorative moldings, veneer laminates, soft and hardwood cabinetry.

Part No.	Diameter	Arbor	Teeth	Grind	Hook	Kerf	Carbide Grade	# of Blades
<b>Fine Finish</b>								
726100	12"	1"	60	ATB	0°	.110"	C2 micrograin	1
988922	15"	1"	80	ATB	6°	.110"	C2 micrograin	1
<b>Ultra Fine Finish</b>								
998862	8-1/2"	5/8"	60	ATB	6°	.087"	C2 micrograin	1
725206	10"	5/8"	72	ATB	15°	.098"	C2 micrograin	1
726101	12"	1"	90	ATB	0°	.110"	C2 micrograin	1
211000	15"	1"	110	ATB/Flat	0°	.118"	C2 micrograin	1

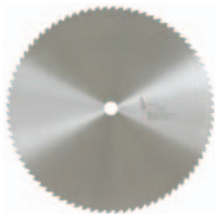

## Steel Saw Blades

Combination general purpose blade for smooth and fast cross cutting, ripping and miter.

Part No.	Diameter	Arbor	Teeth	Kerf	Description	# of Blades
974651Z	15"	1"	80	.078"	Combination	1



## Non-Ferrous Metals

Cross cutting and miter of brass, aluminum, copper and other non-ferrous metals with a miter saw. Lubricants are recommended when used for this application. Good for woodworking and cutting plastics. Tungsten carbide triple-chip grind produces clean cuts

Part No.	Diameter	Arbor	Teeth	Grind	Hook	Kerf	Carbide Grade	# of Blades
998864	8-1/2"	5/8"	60	TCG	8°	.095"	C3 micrograin	1
974642N	10"	5/8"	72	TCG	8°	.096"	C3 micrograin	1
726102	12"	1"	90	TCG	0°	.110"	C3 micrograin	1
211001	15"	1"	110	TCG	0°	.118"	C3 micrograin	1



## Ferrous Metals

Clean, fast cutting of mild steel: Angle, Pipe and Tubing with "dry cut" low RPM miter and cut-off saws. Uniquely designed tooth geometry produces a clean, burr-free cut. Specially formulated carbide provides long life, resists breakage on impact and lasts longer than standard carbide blades and abrasive discs

Part No.	Diameter	Arbor	Teeth	Grind	Hook	Kerf	Carbide Grade	# of Blades
320056	14"	1"	80	TCG	0°	.087"	C6 micrograin	1
726137	14"	1"	80	TCG			C6 micrograin	1



## Jig Saw Blade Information Guide

### TPI (Teeth Per Inch)

To achieve the best possible cutting quality and the fastest cutting time, it is important to match material thickness with the proper blade geometry; 6TPI - 24TPI (Fast - Slow, Thick-Thin, Wood-All Purpose-Metal); Progressive (All)



6 TPI



14 TPI



24 TPI



PROGRESSIVE

### Progressor Tooth Design

The Progressor name comes from the progressive tooth pattern that graduates from high to low teeth per inch over the length of the blade. The progressive tooth pattern is engineered so the blade can cut both thick and thin material cleanly and smoothly. The Progressor line of blades are the ideal blades when switching from one material thickness to another, eliminating the need for blade changes and saving time on the job. Available for wood, metal or all purpose applications.

**HSS (High Speed Steel)**  
Ideal for metal cutting

725381



**Taper Ground**  
For speed and increased blade life.

**Thin Material, Small Teeth**

**Ground Teeth**  
For superior speed and clean cuts

**Thick Material, Large Teeth**

**Tip Engineered**  
For easy plunge cuts.



### BLADE MATERIAL

#### HIGH CARBON STEEL (HCS)

For use in softer materials such as wood, laminated chipboard and plastics.



#### HIGH SPEED STEEL (HSS)

Fully hardened for use in metal, aluminum & non-ferrous metals.



#### BI-METAL (BI-M)

Highly flexible and tough combination of harder HSS teeth and a more flexible HCS body: suitable to use for the most demanding applications.



#### TUNGSTEN CARBIDE (HCS/Grit or HCS/TCT)

Use HCS blades coated with tungsten carbide grit to cut abrasive materials such as glass, ceramic tile, cast-iron and brick. Use HCS blades with tungsten carbide teeth for cutting abrasive materials such as FRP (Fiberglass Reinforced Plastics), hardwoods, aerated concrete, bricks, and fiber cement board.



### TOOTH DESIGN

Designed with optimal tooth spacing, shape and cutting angle to provide the best possible speed, cut and performance.

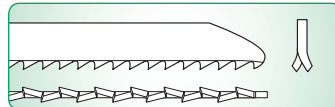

#### Milled and Side Set

For fast, rough cuts in wood and plastics.

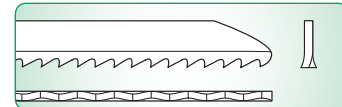

#### Milled and Wavy Set

For cuts in metal, non-ferrous metal, aluminum and plastics.

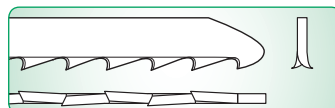

#### Ground and Side Set



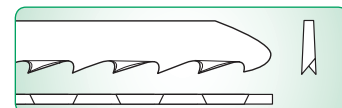







For clean, fast cuts in wood and plastics.

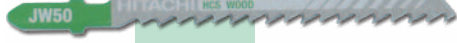

#### Ground and Taper-Ground

For precise, fine, clean cuts in wood.

## WOOD CUTTING

Part No.	Material	Working Length	Total Length	Teeth Per Inch	Tooth Set	Package Quantity
 JW10 725382	HCS	3"	4"	10	Ground	5
 JW10R 725383	HCS	3"	4"	10	Ground	5
 JW11 725384	HCS	3"	4"	6	Ground	5
 JW20 725385	HCS	3"	4"	8	Side	5
 JW30 725386	HCS	2"	3"	12	Wavy	5
 JW40 725387	HCS	3"	4"	6	Side/Ground	5
 JW50 725388	HCS	3"	4"	6	Side/Ground	5
 JW40L 725389	HCS	4"	5-1/4"	6	Side/Ground	5
 JW60 725390	HCS	3"	4-5/8"	8	Ground	5
 JPW30 725391	HCS	3"	4-1/4"	Progressive	Ground	5

Straight fine cutting, hard & soft wood, laminated particle board, plywood and soft plastics 3/16" to 11/4"

Straight fine cutting, hard & soft wood, particle & laminated particle boards and soft plastics 3/16" to 11/4". Reverse teeth for clean, splinter free surface.

Straight coarse fast cutting, hard & soft wood, soft plastics 1/4" to 2-3/8"

Straight coarse fast cutting, hard & soft wood, soft plastics 7/32" to 2-3/8"

Fine straight cutting, hard & soft wood, plywood and particle board 5/64" to 11/4", plexiglass, plastics, insulation material 5/64" to 3/4"

Straight coarse fast cutting, hard & soft wood, particle board 1/4" to 2-3/8"

Fast curve coarse cutting, hard & soft wood, particle board 1/4" - 2-3/8"

Fast straight & parallel cutting, hard & soft wood, particle board 1/4" to 4"









Fast fine cutting, hard & soft wood, particle & laminated particle boards 3/16" to 2-3/8"; plastics 3/16" to 11/4"

Fine straight cutting, thin & thick soft & hard wood, plywood and particle board 3/16" to 3-1/8"



Accessories

## METAL CUTTING

Part No.	Material	Working Length	Total Length	Teeth Per Inch	Tooth Set	Package Quantity
 JM30 725374	HSS	2"	4"	8	Side	5
 JM10 725375	HSS	2"	3"	24	Wavy	5
 JM10B 725376	BI-M	2"	3"	24	Wavy	5
 JM11 725377	HSS	2"	3"	14	Wavy	5
 JM11B 725378	BI-M	2"	3"	14	Wavy	5
 JM20 725379	HSS	3"	4"	8	Wavy	5
 JM41B 725380	BI-M	4"	5-1/4"	14	Wavy	5
 JPM20 725381	HSS	3"	4"	Progressive	Side	5

Straight and curve cutting, non-ferrous metals 1/8" - 1/4", aluminum 1/8" to 5/8", plastics up to 1-1/4", FRP up to 3/4"

Fine straight cutting in thin metal, aluminum, sheet metal & non-ferrous metals 1/16" to 1/8"

Fine straight cutting in thin metal, aluminum, sheet metal & non-ferrous metals 1/16" to 1/8"

Straight cutting in thick metal, aluminum, non-ferrous metals 1/8" to 1/4"

Straight & curve cutting in thick metal, aluminum, non-ferrous metals 1/8" to 1/4"; plexiglass 1/8" to 3/4"

Straight fast cutting in aluminum 3/16" to 5/8"; plastics 3/16" to 11/4"; FRP, lead & tin 3/16" to 3/4"; non-ferrous metal, metal 3/16" to 1/4"

Straight & curve cutting in metal, non-ferrous metals, aluminum 5/64" to 1/4"; sandwich board 5/64" to 3-3/8"; plexiglass 5/64" to 1/4"

Fast cutting, thin & thick metal 1/8" to 3/8", wood with nails and particle board 1/8" to 3-5/8", non-ferrous metals, aluminum, plastics 5/64" to 1/4"





## ALL PURPOSE

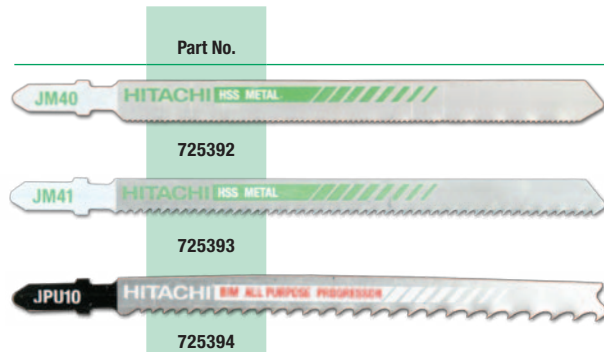

Material	Working Length	Total Length	Teeth Per Inch	Tooth Set	Package Quantity
Straight cutting in metal, non-ferrous metals, aluminum 1/16" to 1/8"; sandwich Board 1/16" to 2-1/2"					
HSS	4"	5-1/4"	24	Wavy	5
Straight cutting in metal, non-ferrous metals, aluminum 5/64" to 5/16"; sandwich board 5/64" to 3-1/8"					
HSS	4"	5-1/4"	14	Wavy	5
Fast cutting, thin & thick metal 1/8" to 3/8", wood with nails and particle board 1/8" to 3-5/8", non-ferrous metals, aluminum, plastics 5/64" to 1-1/4"					
BI-M	4"	5-1/4"	PROGRESSIVE	Side	5

## BRICK & ABRASIVE CUTTING



Material	Working Length	Total Length	Teeth Per Inch	Tooth Set	Package Quantity
Fine straight & curve cutting glass, ceramics, FRP 3/64" to 5/8"					
HCS/GRIT	2"	3"	30 Grit	Carbide Coated	3
Finest straight & curve cutting glass, ceramics 3/64" to 3/8"					
HCS/GRIT	2"	3"	50 Grit	Carbide Coated	3
Fast coarse cutting in abrasive materials; FRP 1/4" to 3/4"; cement bonded particle board 1/4" to 2-3/8" and fiber cement					
HCS/TCT	3"	4"	6	Side/Carbide Tipped	3
Straight cuts in fiberglass, metal, stainless steel 2/25" to 1/5"					
HCS/TCT	2-1/2"	3-1/2"	18	Ground/Carbide Tipped	2
Finest straight & curve cutting glass, ceramics 3/64" to 3/8"					
HCS/GRIT	2-1/8"	3"	50 Grit	Carbide Coated	1
Fine straight & curve cutting glass, ceramics, FRP 3/64" to 5/8"					
HCS/GRIT	2"	3"	30 Grit	Carbide Coated	1

## VARIOUS BLADES

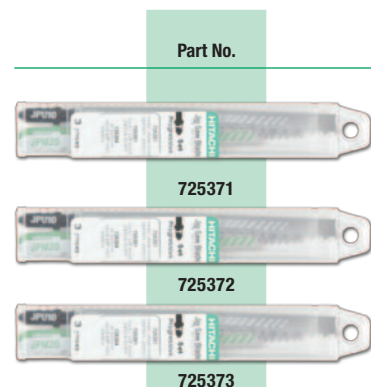

Material	Working Length	Total Length	Teeth Per Inch	Tooth Set	Package Quantity
Set of 24 SKU's (119 T-Shank blades) for PPJN Jig Saw Blade Power Pack Display (use MD102 insert cards): 725373, 725375, 725376, 725377, 725378, 725379, 725380, 725381, 725382, 725283, 725384, 725385, 725386, 725387, 725388, 725389, 725390, 725391, 725392, 725393, 725394, 725395, 725396, 725397					
Various	*	*	*	*	24 SKU's
Set of 3 T-Shank Progressive Tooth Jig Saw Blades: 725381, 725391, 725394					
Various	*	*	*	*	3
Set of 5 T-Shank Jig Saw Blades: 725375, 725377, 725382, 725386, 725387					
Various	*	*	*	*	5

## Reciprocating Saw Blade Information Guide

### TECHNICAL BLADE ANATOMY

#### TPI: Teeth Per Inch

The lower the TPI, the faster the blade will cut. The higher the TPI, the cleaner the blade will cut.

#### Tilt Angle

The tilt angle is the angle at which the blade cuts into the material. A higher tilt angle produces a faster, more aggressive cut. Tilt angle is optimized based on application for best life-to-speed ratio.

#### Gullet

The space between each tooth that collects and clears out the material being cut. The deeper the gullet, the more efficiently the chips are cleared.

#### Blade Shapes

Taper blade bodies are designed for plunge cutting, curve cuts and easier starts in tough to reach applications. Non-taper bodies offer more stability and straighter cuts.

#### Settings

Blade tooth settings vary from one blade to another to optimize cutting efficiency by material applications.

#### Body Thickness

Thinner blades offer faster cutting and flexibility for flush cutting. Thick kerfs offer straighter and more stable cutting.

#### Reinforced Tooth

A wide tooth base with a smaller gullet results in a stronger tooth design.

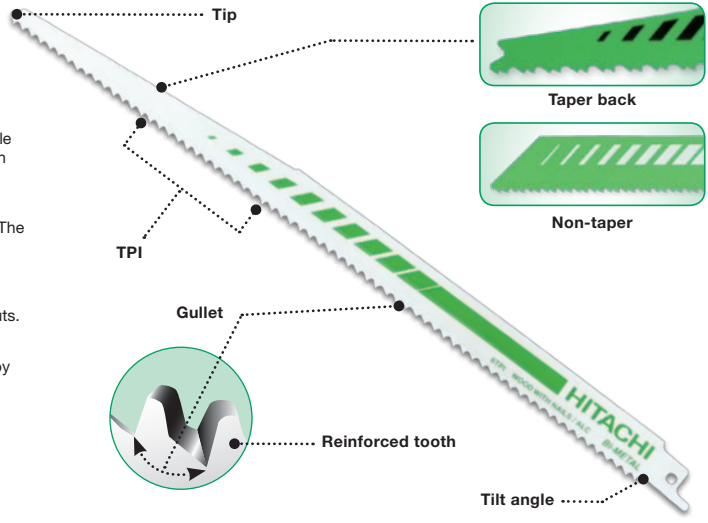

### INCREASES SPEED OF CUT IMPROVES FINISH OF CUT

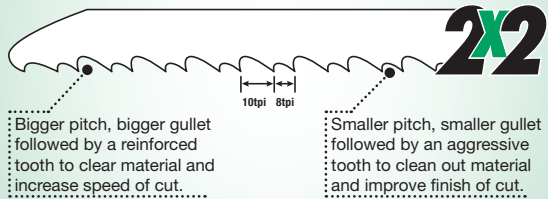

### RECIPROCATING SAW BLADE COLOR CODE

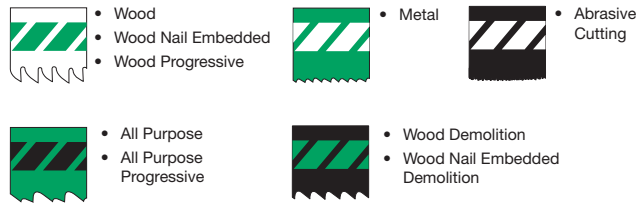

### TOOTH DESIGN

Designed with optimal tooth spacing, shape and cutting angle to provide the best possible speed, cut and performance.

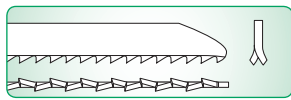

**Side Set and Milled**  
For fast, rough cuts in wood and plastics.

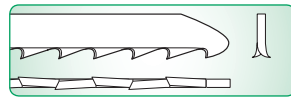

**Side Set and Ground**  
For clean, fast cuts in wood and plastics.

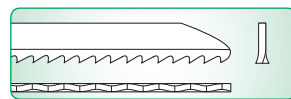

**Wavy Set and Milled**  
For cuts in metal, non-ferrous metal, aluminum and plastics.

### BLADE MATERIAL

#### HIGH CARBON STEEL (HCS)

For use in softer materials such as wood, laminated chipboard, PVC and other plastics.



#### BI-METAL (BI-M)

Highly flexible and tough combination of harder HSS teeth and a more flexible HCS body: suitable to use for the most demanding applications.



#### TUNGSTEN CARBIDE GRIT (HCS/TC Grit)

The HCS blade coated with Tungsten Carbide Grit, used for materials such as glass, ceramic tile, and cast-iron and brick.







#### TUNGSTEN CARBIDE TEETH (HCS/TCT)









The HCS blade with Tungsten Carbide Teeth for cutting abrasive materials such as FRP (Fiberglass Reinforced Plastics), hardwoods, aerated concrete, bricks, and fiber cement board.



## WOOD CUTTING





5 Blade Package	50 Blade Package	Material	Length x Width x Thickness (in)	TPI	Tooth Set
		HCS	6" x 3/4" x .05"	6	Side Set & Ground
725300		Coarse, fast and curve cutting in soft and hard woods, plywood, particleboard and plastics 1/4" to 4"			
		HCS	9" x 3/4" x .05"	5	Side Set & Ground
725301		Very aggressive, coarse, fast cuts in green wood, fire wood, branch pruning (5/8" to 6"). Hardened teeth for extended life.			
		HCS	12" x 3/4" x .05"	6	Side Set & Ground
725302		Coarse, fast and curve cutting in soft and hard woods, plywood, plastics and particleboard 1/4" to 10"			
	725360B50	HCS	8" x 3/4" x .05"	Progressive	Side Set & Ground
725360		Special blade for all wood and composite materials 1/4" to 4". Long lasting progressive tooth design for fast, clean cutting.			

## METAL CUTTING





5 Blade Package	25 Blade Package	50 Blade Package	100 Blade Package	Material	Length x Width x Thickness (in)	TPI	Tooth Set
	725320B25		725320B100	BI-M	6" x 3/4" x .035"	10	Side Set & Milled
725320				Break resistant and flexible in metal, sheet metal, profiles and pipes to 2"; wood with nails 1/8" to 4-3/4"; non-ferrous metal, aluminum 1/8" to 5/8"			
			725321B100	BI-M	9" x 3/4" x .035"	10	Side Set & Milled
725321				Break resistant and flex in metal, sheet metal, profiles and pipes to 2"; wood with nails 1/8" to 7-5/8"; non-ferrous metal, aluminum 1/8" to 5/8" and pallet repair.			
				BI-M	6" x 3/4" x .035"	14	Side Set & Milled
725322				Straight, fast cuts; break resistant flexible profiles and pipes to 2"; thick metal, sheet metal, non-ferrous metal and aluminum 5/64" to 5/16"			
			725323B100	BI-M	9" x 3/4" x .035"	14	Side Set & Milled
725323				Straight, fast cuts; break resistant flexible profiles and pipes to 2"; thick metal, sheet metal, non-ferrous metal and aluminum 5/64" to 5/16"			
			725324B100	BI-M	6" x 3/4" x .035"	18	Side Set & Milled
725324				Straight, fast cuts; break resistant flexible profiles and pipes to 1/2"; thin metal, sheet metal, non-ferrous metal and aluminum 1/16" to 1/8"			
				BI-M	9" x 3/4" x .035"	18	Side Set & Milled
725326				Straight, fast cuts; break resistant flexible profiles and pipes to 1/2"; thin metal, sheet metal, non-ferrous metal and aluminum 1/16" to 1/8"			
				BI-M	6" x 3/4" x .035"	24	Wavy & Milled
725325				Straight, fast cuts; break resistant flexible profiles and pipes to 1/2"; thin metal, sheet metal 1/16" to 1/8"			
				BI-M	9" x 3/4" x .035"	24	Wavy & Milled
725327				Straight, fast cuts; break resistant flexible profiles and pipes to 1/2"; thin metal, sheet metal 3/64" to 1/8"			
		725361B50		BI-M	6" x 3/4" x .035"	Progressive	Side Set & Milled
725361				Special fast, long life blade in fiberglass 3/64" to 1-1/4"; non-ferrous metal 3/64" to 5/8"; stainless steel 3/64" to 1/8"; metal, sheet metal, pipes and profiles 3/64" to 5/16"; plastics 3/64" to 2". Blade is fast, tough and flexible for long service life			

Accessories



## WOOD WITH NAILS

5 Blade Package	25 Blade Package	100 Blade Package	Material	Length x Width x Thickness (in)	TPI	Tooth Set	
			Curve and straight cutting, roughing, fast work, nail-embedded, knotty wood 1/4" to 4"	<b>BI-M</b>	<b>6" x 3/4" x .05"</b>	<b>6</b>	<b>Side Set &amp; Milled</b>
725310		725310B100		<b>BI-M</b>	<b>6" x 3/4" x .05"</b>	<b>6</b>	<b>Side Set &amp; Milled</b>
			Very aggressive, coarse, fast cuts in green wood, fire wood, branch pruning (5/8" to 6"). Hardened teeth for extended life	<b>BI-M</b>	<b>6" x 1/2" x .05"</b>	<b>6</b>	<b>Side Set &amp; Milled</b>
725311				<b>BI-M</b>	<b>6" x 1/2" x .05"</b>	<b>6</b>	<b>Side Set &amp; Milled</b>
			Scroll, curve cutting and fast roughing in soft and hard woods, plywood, plastics, particleboard and wood with nails 1/4" to 4"	<b>BI-M</b>	<b>6" x 3/4" x .05"</b>	<b>6</b>	<b>Side Set &amp; Milled</b>
725312				<b>BI-M</b>	<b>6" x 3/4" x .05"</b>	<b>6</b>	<b>Side Set &amp; Milled</b>
			Roughing, fast work in wood, nail-embedded knotty wood, plastics, center black and insulation board 1/4" to 6"	<b>BI-M</b>	<b>9" x 3/4" x .05"</b>	<b>6</b>	<b>Side Set &amp; Milled</b>
725313	725313B25	725313B100		<b>BI-M</b>	<b>9" x 3/4" x .05"</b>	<b>6</b>	<b>Side Set &amp; Milled</b>
			Roughing, fast work in PVC pipe, plastics, center block, plywood, nail-embedded knotty wood 1/4" to 10"	<b>BI-M</b>	<b>12" x 3/4" x .05"</b>	<b>6</b>	<b>Side Set &amp; Milled</b>
725314	725314B25			<b>BI-M</b>	<b>12" x 3/4" x .05"</b>	<b>6</b>	<b>Side Set &amp; Milled</b>

## ALL PURPOSE CUTTING







5 Blade Package	50 Blade Package	100 Blade Package	Material	Length x Width x Thickness (in)	TPI	Tooth Set	
			Flex and break resistant in nail-embedded wood and sandwich board 1/8" to 4"; metal, non-ferrous metal and aluminum 1/8" to 5/16"; pipes and profiles to 2"; fiberglass 1/8" to 2"; reinforced plastics 1/8" to 2" compositions. Variable tooth pitch allows for use in various materials.	<b>BI-M</b>	<b>6" x 3/4" x .035"</b>	<b>10/14</b>	<b>Side Set &amp; Milled</b>
725330				<b>BI-M</b>	<b>6" x 3/4" x .035"</b>	<b>10/14</b>	<b>Side Set &amp; Milled</b>
			Flex and break resistant in nail-embedded wood and sandwich board 1/8" to 6"; metal, and non-ferrous metal 1/8" to 3/8"; pipes and profiles to 3"; fiberglass 1/8" to 2"; reinforced plastics 1/8" to 6". Variable tooth pitch allows for use in various materials.	<b>BI-M</b>	<b>9" x 3/4" x .035"</b>	<b>10/14</b>	<b>Side Set &amp; Milled</b>
725331	725331B50			<b>BI-M</b>	<b>9" x 3/4" x .035"</b>	<b>10/14</b>	<b>Side Set &amp; Milled</b>
			Break resistant in cutting nail-embedded wood and sandwich board 1/8" to 6"; metal, and non-ferrous metal 1/8" to 3/8"; pipes and profiles to 3"; fiberglass 1/8" to 2"; reinforced plastics 1/8" to 6". Variable tooth pitch provides flexibility.	<b>BI-M</b>	<b>12" x 3/4" x .035"</b>	<b>10/14</b>	<b>Side Set &amp; Milled</b>
725332				<b>BI-M</b>	<b>12" x 3/4" x .035"</b>	<b>10/14</b>	<b>Side Set &amp; Milled</b>
			Fast and long lasting in various materials: wood with nails, particleboard 5/64" to 6"; metal, pipes and profiles 5/64" to 3/8"; aluminum, non-ferrous metals 5/64" to 3/4"; fiberglass 5/64" to 2"; plastic and plater board 5/64" to 6".	<b>BI-M</b>	<b>8" x 3/4" x .035"</b>	<b>Progressive</b>	<b>Side Set &amp; Milled</b>
725362	725362B50	725362B100		<b>BI-M</b>	<b>8" x 3/4" x .035"</b>	<b>Progressive</b>	<b>Side Set &amp; Milled</b>

## DEMOLITION

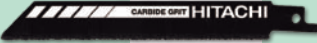

3 Blade Package	25 Blade Package	100 Blade Package	Material	Length x Width x Thickness (in)	TPI	Tooth Set	
			Curve and straight cutting, roughing, fast work, nail-embedded, knotty wood 1/4" to 4"	<b>BI-M</b>	<b>9" x 7/8" x .062"</b>	<b>6</b>	<b>Side Set &amp; Milled</b>
725350	725350B25	725350B100		<b>BI-M</b>	<b>9" x 7/8" x .062"</b>	<b>6</b>	<b>Side Set &amp; Milled</b>
			Very aggressive, coarse, fast cuts in green wood, fire wood, branch pruning (5/8" to 6"). Hardened teeth for extended life	<b>BI-M</b>	<b>9" x 7/8" x .062"</b>	<b>8/10</b>	<b>Side Set &amp; Milled</b>
725351	725351B25			<b>BI-M</b>	<b>9" x 7/8" x .062"</b>	<b>8/10</b>	<b>Side Set &amp; Milled</b>



## FIBER CEMENT AND TILE CUTTING

1 Blade Package	2 Blade Package	3 Blade Package	Material	Length x Width x Thickness (in)	TPI	Tooth Set
			Straight cuts in fiberglass, fiber reinforced cement, slate, plaster	HCS/TC GRIT	6" x 3/4" x .05"	Grit Coarse
728795C						
			Straight cuts in fiberglass, fiber reinforced cement, slate, plaster	HCS/TC GRIT	8" x 3/4" x .05"	Grit Coarse
728796C						
			Straight cuts in fiberglass 5/64" to 5/8"; metal 5/64" to 7/32"; stainless steel 5/64 to 3/16	HCS/TCT	4-1/2" x 3/4" x .05"	18 Carbide Strip & Ground
	725342					
			Scroll, straight coarse, fast cuts in fiber-cement board, fiberglass; cement center block, abrasive materials; cement bonded particleboard 1/4" to 4"	HCS/TCT	9" x 3/4" x .05"	6 Side Set & Ground
	725344					
			Roughing, fast straight coarse, fast cuts in brick, abrasive materials, fiber cement 0.4" to 10" center block 1/4" to 10"; fiberglass 1/4" to 6"	HCS/TCT	12" x 3/4" x .06"	3 Side Set & Ground
	725348					
			Straight coarse, fast cuts in brick, abrasive materials, fiber cement 0.8" to 14", center block 1/4" to 14"; fiberglass 1/4" to 6"	HCS/TCT	16" x 3/4" x .06"	2 Side Set & Ground
	725349					
			Straight cuts in iron pipe, steel up to 6"; fiberglass, reinforced plastics, ceramic tile, stone, slate and brick 3/64" to 7-1/4"	HCS/TC GRIT	9" x 3/4" x .05"	Grit Coarse
		725340				

## BRICK AND ABRASIVE CUTTING BLADES

1 Blade	Material	Length x Width x Thickness (in)	TPI	Tooth Set
	Ideal for cutting various types of abrasive materials including red brick, fiber cement and aerated concrete. This blade features high quality carbide teeth to help give your blade a longer live as well as reducing dust and tearing during cuts.	HCS/TCT	9-1/2" x 3/8" x .05"	2 Side Set & Ground
752040				
	Ideal for cutting various types of abrasive materials including red brick, fiber cement and aerated concrete. This blade features high quality carbide teeth to help give your blade a longer live as well as reducing dust and tearing during cuts.	HCS/TCT	12" x 3/8" x .05"	2 Side Set & Ground
752041				
	Ideal for cutting various types of abrasive materials including red brick, fiber cement and aerated concrete. This blade features high quality carbide teeth to help give your blade a longer live as well as reducing dust and tearing during cuts.	HCS/TCT	18" x 3/8" x .05"	2 Side Set & Ground
752042				

25 PACK

50 PACK



P/N 725350B25

P/N 725360B50

## FIBER CEMENT HOLE SAWS

For use with drills, hammer drills and rotary hammers in fiber cement and nail embedded wood.

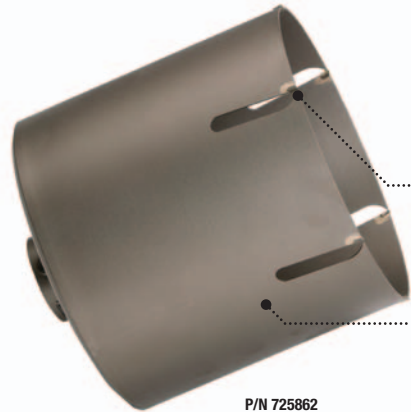

Various types of shank adapters allow flexible and economical use of the system

6 carbide tips provide high speed penetration

Wide range of diameters for variety applications

P/N 725862

## HOLE SAWS



P/N 725856

Part No.	Diameter	Description	Qty
725850	1" Thin Wall	Hole Saw for Fiber Cement / Nail Embedded Wood	1
725851	1-1/8" Thin Wall	Hole Saw for Fiber Cement / Nail Embedded Wood	1
725852	1-1/4" Thin Wall	Hole Saw for Fiber Cement / Nail Embedded Wood	1
725853	1-3/8" Thin Wall	Hole Saw for Fiber Cement / Nail Embedded Wood	1
725854	1-1/2" Thin Wall	Hole Saw for Fiber Cement / Nail Embedded Wood	1
725855	1-3/4" Thin Wall	Hole Saw for Fiber Cement / Nail Embedded Wood	1
725856	2" Thin Wall	Hole Saw for Fiber Cement / Nail Embedded Wood	1
725857	2-3/8" Thin Wall	Hole Saw for Fiber Cement / Nail Embedded Wood	1
725858	2-1/2" Thin Wall	Hole Saw for Fiber Cement / Nail Embedded Wood	1
725859	3" Thin Wall	Hole Saw for Fiber Cement / Nail Embedded Wood	1
725860	4" Thin Wall	Hole Saw for Fiber Cement / Nail Embedded Wood	1
725861	5" Thin Wall	Hole Saw for Fiber Cement / Nail Embedded Wood	1
725862	6" Thin Wall	Hole Saw for Fiber Cement / Nail Embedded Wood	1
725863	6-1/2" Thin Wall	Hole Saw for Fiber Cement / Nail Embedded Wood	1
725864	7" Thin Wall	Hole Saw for Fiber Cement / Nail Embedded Wood	1
725865	8" Thin Wall	Hole Saw for Fiber Cement / Nail Embedded Wood	1

## ARBOR AND PILOT DRILLS



P/N 725872

Part No.	Shank Diameter	Description	Shank	Qty
725870	3/8"	Fits 1" to 1-3/4" Hole Saws	Straight	1
725871	N/A	Fits 1" to 1-3/4" Hole Saws	SDS +	1
725872	1/2"	Fits Greater than 2" Hole Saws	Straight	1
725873	N/A	Fits Greater than 2" Hole Saws	SDS +	1
725875	N/A	Fits Greater than 2" Hole Saws	SDS Max	1
725880	N/A	Pilot Drill Bit for TCT Fiber Cement Board	N/A	1
725881	N/A	Pilot Drill Bit for HSS for Wood with Nails	N/A	1



### 135° Split Point

Drill bits start on contact without wobbling or walking. Starts a hole in harder materials without a center punch and generates less heat than a standard bit for increased bit life.

### 1/4" Hex Shank

Easy to chuck, eliminates bit slip and spin-out, compatible with the Quick Change connector for quick bit change.

### Screw Guides

Holds the screw in the correct position without wobbling or disengaging from the bit. Most useful with extra long screws.

### Drill & Driver

Most versatile drilling and driving accessories available for professionals and do-it-yourselfers. Four times faster than standard drilling and driving.

### Quick Change Connector

Allows for fast and easy one-handed bit changes without re-chucking. Manufactured from high-quality materials for superior strength and lasting durability.



Accessories

## BLACKGOLD DRILL BITS

### BLACKGOLD™



P/N 728075

Part No.	Description	Diameter	Shank Diameter	Overall Length	Package Qty
728047	Round Shank Black Gold Drill Bit	1/16"	1/16"	1-7/8"	2
728048	Round Shank Black Gold Drill Bit	5/64"	5/64"	2"	2
728049	Round Shank Black Gold Drill Bit	3/32"	3/32"	2-1/4"	2
728050	Round Shank Black Gold Drill Bit	7/64"	7/64"	2-5/8"	2
728051	Round Shank Black Gold Drill Bit	1/8"	1/8"	2-3/4"	2
728052	Round Shank Black Gold Drill Bit	9/64"	9/64"	2-7/8"	1
728053	Round Shank Black Gold Drill Bit	5/32"	5/32"	3-1/8"	1
728054	Round Shank Black Gold Drill Bit	11/64"	11/64"	3-1/4"	1
728055	Round Shank Black Gold Drill Bit	3/16"	3/16"	3-1/2"	1
728056	Round Shank Black Gold Drill Bit	13/64"	13/64"	3-5/8"	1
728057	Round Shank Black Gold Drill Bit	7/32"	7/32"	3-3/4"	1
728058	Round Shank Black Gold Drill Bit	15/64"	15/64"	3-7/8"	1
728059	Round Shank Black Gold Drill Bit	1/4"	1/4"	4"	1
728060	Round Shank Black Gold Drill Bit	17/64"	17/64"	4-1/8"	1
728061	Round Shank Black Gold Drill Bit	9/32"	9/32"	4-1/4"	1
728062	Round Shank Black Gold Drill Bit	19/64"	19/64"	4-3/8"	1
728063	Round Shank Black Gold Drill Bit	5/16"	5/16"	4-1/2"	1
728064	Round Shank Black Gold Drill Bit	21/64"	21/64"	4-5/8"	1
728065	Round Shank Black Gold Drill Bit	11/32"	11/32"	4-3/4"	1
728066	Round Shank Black Gold Drill Bit	23/64"	23/64"	4-7/8"	1
728067	Round Shank Black Gold Drill Bit	3/8"	3/8"	5"	1
728068	Round Shank Black Gold Drill Bit	25/64"	3/8"	5-1/8"	1
728069	Round Shank Black Gold Drill Bit	13/32"	3/8"	5-1/4"	1
728070	Round Shank Black Gold Drill Bit	27/64"	3/8"	5-3/8"	1
728071	Round Shank Black Gold Drill Bit	7/16"	3/8"	5-1/2"	1
728072	Round Shank Black Gold Drill Bit	29/64"	3/8"	5-5/8"	1
728073	Round Shank Black Gold Drill Bit	15/32"	3/8"	5-3/4"	1
728074	Round Shank Black Gold Drill Bit	31/64"	3/8"	5-7/8"	1
728075	Round Shank Black Gold Drill Bit	1/2"	3/8"	6"	1

## BLACKGOLD BIT SETS



P/N 728081

Part No.	Description	Diameter	Shank	Package Qty
728029	7-Piece Black Gold Drill Bit Set	1/16" - 3/16"	Round	7
728080	14-Piece Black Gold Drill Bit Set	1/16" - 3/8"	Round	14
728081	17-Piece Black Gold Drill Bit Set	1/16" - 1/2"	Round	17

## BLACKGOLD BIT DISPLAYS

Part No.	Description	Package Qty
HAD03	Black Gold Bit Planogram (29 SKUs, 2 Bits per SKU)	58
728089	Bulk Counter Top Display Case (29 SKUs, 1 Bits per SKU)	29



## TITANIUM BITS



P/N 728152

Part Number	Description	Diameter	Shank Diameter	Overall Length	Package Qty
728140	3-Flat Shank Titanium Drill Bit	1/16"	1/16"	1-7/8"	2
728141	3-Flat Shank Titanium Drill Bit	5/64"	5/64"	2"	2
728142	3-Flat Shank Titanium Drill Bit	3/32"	3/32"	2-1/4"	2
728143	3-Flat Shank Titanium Drill Bit	7/64"	7/64"	2-5/8"	2
728144	3-Flat Shank Titanium Drill Bit	1/8"	1/8"	2-3/4"	2
728145	3-Flat Shank Titanium Drill Bit	9/64"	9/64"	2-7/8"	1
728146	3-Flat Shank Titanium Drill Bit	5/32"	5/32"	3-1/8"	1
728147	3-Flat Shank Titanium Drill Bit	11/64"	11/64"	3-1/4"	1
728148	3-Flat Shank Titanium Drill Bit	3/16"	3/16"	3-1/2"	1
728149	3-Flat Shank Titanium Drill Bit	13/64"	13/64"	3-5/8"	1
728150	3-Flat Shank Titanium Drill Bit	7/32"	7/32"	3-3/4"	1
728151	3-Flat Shank Titanium Drill Bit	15/64"	15/64"	3-7/8"	1
728152	3-Flat Shank Titanium Drill Bit	1/4"	1/4"	4"	1
728153	3-Flat Shank Titanium Drill Bit	17/64"	17/64"	4-1/8"	1
728154	3-Flat Shank Titanium Drill Bit	9/32"	9/32"	4-1/4"	1
728155	3-Flat Shank Titanium Drill Bit	19/64"	19/64"	4-3/8"	1
728156	3-Flat Shank Titanium Drill Bit	5/16"	5/16"	4-1/2"	1
728157	3-Flat Shank Titanium Drill Bit	21/64"	21/64"	4-5/8"	1
728158	3-Flat Shank Titanium Drill Bit	11/32"	11/32"	4-3/4"	1
728159	3-Flat Shank Titanium Drill Bit	23/64"	23/64"	4-7/8"	1
728160	3-Flat Shank Titanium Drill Bit	3/8"	3/8"	5"	1
728161	3-Flat Shank Titanium Drill Bit	25/64"	3/8"	5-1/8"	1
728162	3-Flat Shank Titanium Drill Bit	13/32"	3/8"	5-1/4"	1
728163	3-Flat Shank Titanium Drill Bit	27/64"	3/8"	5-3/8"	1
728164	3-Flat Shank Titanium Drill Bit	7/16"	3/8"	5-1/2"	1
728165	3-Flat Shank Titanium Drill Bit	29/64"	3/8"	5-5/8"	1
728166	3-Flat Shank Titanium Drill Bit	15/32"	3/8"	5-3/4"	1
728167	3-Flat Shank Titanium Drill Bit	31/64"	3/8"	5-7/8"	1
728168	3-Flat Shank Titanium Drill Bit	1/2"	3/8"	6"	1
728040	1/4" Hex Shank HSS Titanium Drill Bit	1/16"	1/4" Hex	2-1/2"	1
728041	1/4" Hex Shank HSS Titanium Drill Bit	5/64"	1/4" Hex	2-5/8"	1
728042	1/4" Hex Shank HSS Titanium Drill Bit	3/32"	1/4" Hex	2-3/4"	1
728043	1/4" Hex Shank HSS Titanium Drill Bit	7/64"	1/4" Hex	3-1/4"	1
728044	1/4" Hex Shank HSS Titanium Drill Bit	1/8"	1/4" Hex	3-3/8"	1
728046	1/4" Hex Shank HSS Titanium Drill Bit	3/16"	1/4" Hex	4"	1
728045	1/4" Hex Shank HSS Titanium Drill Bit	1/4"	1/4" Hex	4-5/8"	1

## TITANIUM BIT SETS



P/N 728174

Part Number	Description	Diameter	Shank	Package Qty
728173	14-Piece Titanium Bit Drill Set	1/16" - 3/8"	3-Flat	14
728174	17-Piece Titanium Bit Drill Set	1/16" - 1/2"	3-Flat	17
728093	14-Piece 1/4" Hex Shank HSS Titanium Drill Bit Set	1/16" - 1/4"	1/4" Hex	14

## TITANIUM BIT DISPLAYS

Part Number	Description	Package Qty
HAD01	Titanium Drill Bit Planogram (29 SKUs, 2 Bits Per SKU)	58

## COUNTERSINKS



P/N 728003

Part Number	Description	Diameter	Shank Diameter	Size	Pilot Hole	Package Qty
728000	Quick Change Power Groove Countersinks	5/16"	1/4" Hex	#6	3/32"	1
728001	Quick Change Power Groove Countersinks	5/16"	1/4" Hex	#8	7/64"	1
728002	Quick Change Power Groove Countersinks	3/8"	1/4" Hex	#10	1/8"	1
728003	Quick Change Power Groove Countersinks	3/8"	1/4" Hex	#12	1/8"	1

## COUNTERSINK SETS



P/N 728004

Part Number	Description	Shank Diameter	Size	Package Qty
728004	Quick Change Power Groove Countersink Set	1/4" Hex	#6, #8, #10, #12	4

## REDUCED SHANK BITS



P/N 728039

Part Number	Description	Diameter	Shank	Flute Length	Overall Length	Package Qty
728036	135° Split Point HSS Black Oxide Reduced Shank Drill Bit	9/16"	Round	3"	6"	1
728037	135° Split Point HSS Black Oxide Reduced Shank Drill Bit	5/8"	Round	3"	6"	1
728038	135° Split Point HSS Black Oxide Reduced Shank Drill Bit	3/4"	Round	3"	6"	1
728039	135° Split Point HSS Black Oxide Reduced Shank Drill Bit	1"	Round	3"	6"	1

## 6" AUGER BITS



P/N 728218

Part Number	Description	Diameter	Shank Diameter	Overall Length	Package Qty
728210	Auger Drill Bit	1/4"	1/4"	6"	1
728211	Auger Drill Bit	5/16"	5/16"	6"	1
728212	Auger Drill Bit	3/8"	3/8"	6"	1
728213	Auger Drill Bit	7/16"	3/8"	6"	1
728214	Auger Drill Bit	1/2"	3/8"	6"	1
728215	Auger Drill Bit	9/16"	3/8"	6"	1
728216	Auger Drill Bit	5/8"	3/8"	6"	1
728217	Auger Drill Bit	11/16"	3/8"	6"	1
728218	Auger Drill Bit	3/4"	3/8"	6"	1
728219	Auger Drill Bit	13/16"	3/8"	6"	1
728220	Auger Drill Bit	7/8"	3/8"	6"	1
728221	Auger Drill Bit	15/16"	3/8"	6"	1
728222	Auger Drill Bit	1"	3/8"	6"	1

## 8" AUGER BITS



P/N 728233

Part Number	Description	Diameter	Shank Diameter	Overall Length	Package Qty
728225	Auger Drill Bit	1/4"	1/4"	8"	1
728226	Auger Drill Bit	5/16"	5/16"	8"	1
728227	Auger Drill Bit	3/8"	3/8"	8"	1
728228	Auger Drill Bit	7/16"	3/8"	8"	1
728229	Auger Drill Bit	1/2"	3/8"	8"	1
728230	Auger Drill Bit	9/16"	3/8"	8"	1
728231	Auger Drill Bit	5/8"	3/8"	8"	1
728232	Auger Drill Bit	11/16"	3/8"	8"	1
728233	Auger Drill Bit	3/4"	3/8"	8"	1
728234	Auger Drill Bit	13/16"	3/8"	8"	1
728235	Auger Drill Bit	7/8"	3/8"	8"	1
728236	Auger Drill Bit	15/16"	3/8"	8"	1
728237	Auger Drill Bit	1"	3/8"	8"	1

## 12" AUGER BITS



P/N 728252

Part Number	Description	Diameter	Shank Diameter	Overall Length	Package Qty
728240	Auger Drill Bit	1/4"	1/4"	12"	1
728241	Auger Drill Bit	5/16"	5/16"	12"	1
728242	Auger Drill Bit	3/8"	3/8"	12"	1
728243	Auger Drill Bit	7/16"	3/8"	12"	1
728244	Auger Drill Bit	1/2"	3/8"	12"	1
728245	Auger Drill Bit	9/16"	3/8"	12"	1
728246	Auger Drill Bit	5/8"	3/8"	12"	1
728247	Auger Drill Bit	11/16"	3/8"	12"	1
728248	Auger Drill Bit	3/4"	3/8"	12"	1
728249	Auger Drill Bit	13/16"	3/8"	12"	1
728250	Auger Drill Bit	7/8"	3/8"	12"	1
728251	Auger Drill Bit	15/16"	3/8"	12"	1
728252	Auger Drill Bit	1"	3/8"	12"	1

Accessories

## 18" AUGER BITS



P/N 728267

Part Number	Description	Diameter	Shank Diameter	Overall Length	Package Qty
728255	Auger Drill Bit	1/4"	1/4"	18"	1
728256	Auger Drill Bit	5/16"	5/16"	18"	1
728257	Auger Drill Bit	3/8"	3/8"	18"	1
728258	Auger Drill Bit	7/16"	3/8"	18"	1
728259	Auger Drill Bit	1/2"	3/8"	18"	1
728260	Auger Drill Bit	9/16"	3/8"	18"	1
728261	Auger Drill Bit	5/8"	3/8"	18"	1
728262	Auger Drill Bit	11/16"	3/8"	18"	1
728263	Auger Drill Bit	3/4"	3/8"	18"	1
728264	Auger Drill Bit	13/16"	3/8"	18"	1
728265	Auger Drill Bit	7/8"	3/8"	18"	1
728266	Auger Drill Bit	15/16"	3/8"	18"	1
728267	Auger Drill Bit	1"	3/8"	18"	1

## 22" AUGER BITS



P/N 728282

Part Number	Description	Diameter	Shank Diameter	Overall Length	Package Qty
728270	Auger Drill Bit	1/4"	1/4"	22"	1
728271	Auger Drill Bit	5/16"	5/16"	22"	1
728272	Auger Drill Bit	3/8"	3/8"	22"	1
728273	Auger Drill Bit	7/16"	3/8"	22"	1
728274	Auger Drill Bit	1/2"	3/8"	22"	1
728275	Auger Drill Bit	9/16"	3/8"	22"	1
728276	Auger Drill Bit	5/8"	3/8"	22"	1
728277	Auger Drill Bit	11/16"	3/8"	22"	1
728278	Auger Drill Bit	3/4"	3/8"	22"	1
728279	Auger Drill Bit	13/16"	3/8"	22"	1
728280	Auger Drill Bit	7/8"	3/8"	22"	1
728281	Auger Drill Bit	15/16"	3/8"	22"	1
728282	Auger Drill Bit	1"	3/8"	22"	1

## AUGER BIT SETS & DISPLAYS



P/N 728499

Part Number	Description	Diameter	Overall Length	Package Qty
728499	4-Piece Auger Drill Bit Set	3/8", 1/2", 3/4", 15/16"	6"	4
HAD07	6" Auger Bit Planogram- 12" Rack for Display	14 SKUs- 2 Bits per SKU	6"	28
HAD09	8" Auger Bit Planogram- 12" Rack for Display	13 SKUs- 2 Bits per SKU	8"	26
HAD11	12" Auger Bit Planogram- 12" Rack for Display	13 SKUs- 2 Bits per SKU	12"	26
HAD13	18" Auger Bit Planogram- 12" Rack for Display	13 SKUs- 2 Bits per SKU	18"	26

## 4" SPADE BITS



P/N 728285

Part Number	Description	Diameter	Shank Diameter	Overall Length	Package Qty
728285	Hex Shank Wood Boring Spade Bit	1/2"	1/4"	4"	1
728286	Hex Shank Wood Boring Spade Bit	5/8"	1/4"	4"	1
728287	Hex Shank Wood Boring Spade Bit	3/4"	1/4"	4"	1
728288	Hex Shank Wood Boring Spade Bit	7/8"	1/4"	4"	1
728289	Hex Shank Wood Boring Spade Bit	1"	1/4"	4"	1
728290	Hex Shank Wood Boring Spade Bit	1-1/4"	1/4"	4"	1
728291	Hex Shank Wood Boring Spade Bit	1-1/2"	1/4"	4"	1

## 6" SPADE BITS



P/N 728295

Part Number	Description	Diameter	Shank Diameter	Overall Length	Package Qty
728295	Hex Shank Wood Boring Spade Bit	1/4"	1/4"	6"	1
728296	Hex Shank Wood Boring Spade Bit	5/16"	1/4"	6"	1
728297	Hex Shank Wood Boring Spade Bit	3/8"	1/4"	6"	1
728298	Hex Shank Wood Boring Spade Bit	7/16"	1/4"	6"	1
728299	Hex Shank Wood Boring Spade Bit	1/2"	1/4"	6"	1
728300	Hex Shank Wood Boring Spade Bit	9/16"	1/4"	6"	1
728301	Hex Shank Wood Boring Spade Bit	5/8"	1/4"	6"	1
728302	Hex Shank Wood Boring Spade Bit	11/16"	1/4"	6"	1
728303	Hex Shank Wood Boring Spade Bit	3/4"	1/4"	6"	1
728304	Hex Shank Wood Boring Spade Bit	13/16"	1/4"	6"	1
728305	Hex Shank Wood Boring Spade Bit	7/8"	1/4"	6"	1
728306	Hex Shank Wood Boring Spade Bit	15/16"	1/4"	6"	1
728307	Hex Shank Wood Boring Spade Bit	1"	1/4"	6"	1
728308	Hex Shank Wood Boring Spade Bit	1-1/8"	1/4"	6"	1
728309	Hex Shank Wood Boring Spade Bit	1-1/4"	1/4"	6"	1
728310	Hex Shank Wood Boring Spade Bit	1-3/8"	1/4"	6"	1
728311	Hex Shank Wood Boring Spade Bit	1-1/2"	1/4"	6"	1

## 12" SPADE BITS



P/N 728320

Part Number	Description	Diameter	Shank Diameter	Overall Length	Package Qty
728314	Hex Shank Wood Boring Spade Bit	3/8"	1/4"	12"	1
728315	Hex Shank Wood Boring Spade Bit	1/2"	1/4"	12"	1
728316	Hex Shank Wood Boring Spade Bit	5/8"	1/4"	12"	1
728317	Hex Shank Wood Boring Spade Bit	3/4"	1/4"	12"	1
728318	Hex Shank Wood Boring Spade Bit	7/8"	1/4"	12"	1
728319	Hex Shank Wood Boring Spade Bit	1"	1/4"	12"	1
728320	Hex Shank Wood Boring Spade Bit	1-1/4"	1/4"	12"	1
728321	Hex Shank Wood Boring Spade Bit	1-1/2"	1/4"	12"	1

Accessories

## 18" SPADE BITS



P/N 728329

Part Number	Description	Diameter	Shank Diameter	Overall Length	Package Qty
728324	Hex Shank Wood Boring Spade Bit	3/8"	1/4"	18"	1
728325	Hex Shank Wood Boring Spade Bit	1/2"	1/4"	18"	1
728326	Hex Shank Wood Boring Spade Bit	5/8"	1/4"	18"	1
728327	Hex Shank Wood Boring Spade Bit	3/4"	1/4"	18"	1
728328	Hex Shank Wood Boring Spade Bit	7/8"	1/4"	18"	1
728329	Hex Shank Wood Boring Spade Bit	1"	1/4"	18"	1
728330	Hex Shank Wood Boring Spade Bit	1-1/4"	1/4"	18"	1
728331	Hex Shank Wood Boring Spade Bit	1-1/2"	1/4"	18"	1

## SPADE BIT SETS & DISPLAYS



Part Number	Description	Diameter	Overall Length	Package Qty
728498	4-Piece Spade Bit Set	1/2", 5/8", 3/4", 1"	4"	4
HAD17	4" Spade Bit Planogram- 12" Rack for Display	8 SKUs- 2 Bits per SKU	4"	16
HAD19	6" Spade Bit Planogram- 23" Rack for Display	17 SKUs- 2 Bits per SKU	6"	34
HAD21	12" Spade Bit Planogram- 12" Rack for Display	8 SKUs- 2 Bits per SKU	12"	16
HAD23	18" Spade Bit Planogram- 12" Rack for Display	8 SKUs- 2 Bits per SKU	18"	16

## BLACKGOLD INSTALLER BITS

**BLACKGOLD™**



P/N 728033G

Part Number	Description	Diameter	Shank Diameter	Overall Length	Package Qty
728030G	Installer/Aircraft Drill Bit- HSS Black Gold	1/8"		6"	1
728031G	Installer/Aircraft Drill Bit- HSS Black Gold	3/16"		6"	1
728032G	Installer/Aircraft Drill Bit- HSS Black Gold	1/4"		6"	1
728033G	Installer/Aircraft Drill Bit- HSS Black Gold	5/16"		6"	1
728034G	Installer/Aircraft Drill Bit- HSS Black Gold	3/8"		6"	1
728035G	Installer/Aircraft Drill Bit- HSS Black Gold	1/2"		6"	1
728480G	Installer/Aircraft Drill Bit- HSS Black Gold	1/8"		12"	1
728481G	Installer/Aircraft Drill Bit- HSS Black Gold	3/16"		12"	1
728482G	Installer/Aircraft Drill Bit- HSS Black Gold	1/4"		12"	1
728483G	Installer/Aircraft Drill Bit- HSS Black Gold	5/16"		12"	1
728484G	Installer/Aircraft Drill Bit- HSS Black Gold	3/8"		12"	1
728485G	Installer/Aircraft Drill Bit- HSS Black Gold	1/2"		12"	1

## HSS INSTALLER BITS



Part Number	Description	Diameter	Shank Diameter	Overall Length	Package Qty
728450	Installer/Aircraft Drill Bit - HSS	1/4"	1/4"	12"	1
728451	Installer/Aircraft Drill Bit - HSS	5/16"	1/3"	12"	1
728452	Installer/Aircraft Drill Bit - HSS	3/8"	3/8"	12"	1
728453	Installer/Aircraft Drill Bit - HSS	1/2"	3/8"	12"	1
728454	Installer/Aircraft Drill Bit - HSS	3/4"	3/8"	12"	1
728470	Installer/Aircraft Drill Bit - HSS	1/4"	1/4"	18"	1
728471	Installer/Aircraft Drill Bit - HSS	5/16"	1/3"	18"	1
728472	Installer/Aircraft Drill Bit - HSS	3/8"	3/8"	18"	1
728473	Installer/Aircraft Drill Bit - HSS	1/2"	3/8"	18"	1
728474	Installer/Aircraft Drill Bit - HSS	3/4"	3/8"	18"	1

## INSTALLER BIT DISPLAY

Part Number	Description	Diameter	Package Qty
HAD29	Installer/Aircraft Bit Planogram- 12" Rack for Display	10 SKUs- 2 Bits per SKU	20



## COBALT BITS



P/N 728175

Part Number	Description	Diameter	Shank Diameter	Overall Length	Package Qty
728175	Round Shank Cobalt Drill Bit	1/16"	1/16"	1-7/8"	2
728176	Round Shank Cobalt Drill Bit	5/64"	5/64"	2"	2
728177	Round Shank Cobalt Drill Bit	3/32"	3/32"	2-1/4"	2
728178	Round Shank Cobalt Drill Bit	7/64"	7/64"	2-5/8"	2
728179	Round Shank Cobalt Drill Bit	1/8"	1/8"	2-3/4"	2
728180	Round Shank Cobalt Drill Bit	9/64"	9/64"	2-7/8"	1
728181	Round Shank Cobalt Drill Bit	5/32"	5/32"	3-1/8"	1
728182	Round Shank Cobalt Drill Bit	11/64"	11/64"	3-1/4"	1
728183	Round Shank Cobalt Drill Bit	3/16"	3/16"	3-1/2"	1
728184	Round Shank Cobalt Drill Bit	13/64"	13/64"	3-5/8"	1
728185	Round Shank Cobalt Drill Bit	7/32"	7/32"	3-3/4"	1
728186	Round Shank Cobalt Drill Bit	15/64"	15/64"	3-7/8"	1
728187	Round Shank Cobalt Drill Bit	1/4"	1/4"	4"	1
728188	Round Shank Cobalt Drill Bit	17/64"	17/64"	4-1/8"	1
728189	Round Shank Cobalt Drill Bit	9/32"	9/32"	4-1/4"	1
728190	Round Shank Cobalt Drill Bit	19/64"	19/64"	4-3/8"	1
728191	Round Shank Cobalt Drill Bit	5/16"	5/16"	4-1/2"	1
728192	Round Shank Cobalt Drill Bit	21/64"	21/64"	4-5/8"	1
728193	Round Shank Cobalt Drill Bit	11/32"	11/32"	4-3/4"	1
728194	Round Shank Cobalt Drill Bit	23/64"	23/64"	4-7/8"	1
728195	Round Shank Cobalt Drill Bit	3/8"	3/8"	5"	1
728196	Round Shank Cobalt Drill Bit	25/64"	3/8"	5-1/8"	1
728197	Round Shank Cobalt Drill Bit	13/32"	3/8"	5-1/4"	1
728198	Round Shank Cobalt Drill Bit	27/64"	3/8"	5-3/8"	1
728199	Round Shank Cobalt Drill Bit	7/16"	3/8"	5-1/2"	1
728200	Round Shank Cobalt Drill Bit	29/64"	3/8"	5-5/8"	1
728201	Round Shank Cobalt Drill Bit	15/32"	3/8"	5-3/4"	1
728202	Round Shank Cobalt Drill Bit	31/64"	3/8"	5-7/8"	1
728203	Round Shank Cobalt Drill Bit	1/2"	3/8"	6"	1

## COBALT BIT SET & DISPLAY



P/N 728088

Part Number	Description	Diameter	Package Qty
728088	13-Piece Cobalt Bit Set	1/16" - 3/8"	13
HAD05	Cobalt Drill Bit Planogram - 23" Rack for Display	29 SKUs/2 Bits per SKU	58

## BLACK OXIDE INSTALLER BITS



P/N 728035

Part Number	Description	Dia.	Shank	Flute Length	Overall Length	Package Qty
728030G	Black Oxide Aircraft Length 135° Split Point HSS Drill Bit	1/8"	Round	1-5/8"	6"	1
728031G	Black Oxide Aircraft Length 135° Split Point HSS Drill Bit	3/16"	Round	2-5/16"	6"	1
728032G	Black Oxide Aircraft Length 135° Split Point HSS Drill Bit	1/4"	Round	2-3/4"	6"	1
728033G	Black Oxide Aircraft Length 135° Split Point HSS Drill Bit	5/16"	Round	3-3/16"	6"	1
728034G	Black Oxide Aircraft Length 135° Split Point HSS Drill Bit	3/8"	Round	3-5/8"	6"	1
728035G	Black Oxide Aircraft Length 135° Split Point HSS Drill Bit	1/2"	Round	4-1/2"	6"	1





Diamond Grit Drill Bits drill through glass, marble, class 5 porcelain, granite and slate. They significantly outperform the standard carbide glass and tile bits on the market today, both in speed of drilling and the number of holes that can be drilled per bit.

These bits feature raised lips with diamond grit particles that are uniquely sintered in place. This process allows the diamonds to adhere to the bit and not grind down as quickly as other sintering processes.

To use freehand, the user accurately positions the bit at an angle to pilot the hole. As the hole edge is defined, the user can slowly center it directly above and begin to drill down eliminating the risk of drill bit wander. As the bit drills down through material, the hollow barrel of the bit creates a core that helps guides the drill and keeps it on track with no chance of skating. A convenient core removal ejection slot pushes the core material out from the bit ensuring hole after hole can be drilled without delay.

The Hitachi diamond grit drill bit bodies are constructed of hardened and tempered thin wall alloy steel. They require water lubrication during use. This can be simply applied with a spray bottle- producing a small puddle of water that is spiral fed down the reverse flute threads on the bit to continuously supply water to the cutting edge, cooling the bit tip, and extending its life.

Additionally, if the hole is being drilled into a vertical surface, Hitachi offers a Drill Guide and Water Cooling System. This unique system can be found packaged along with a drill bit as well as sold separately. It is comprised of a drill bit guide for the five different sizes and helps direct the bit into the exact spot for accurate placement of a hole.

## DIAMOND GRIT GLASS & TILE BITS



P/N 728026

Part No	Description	Diameter	Quantity
728019	Water Feature Attachment	<3/8"	1
728020	Diamond Grit Drill Bit	3/16"	1
728022	Diamond Grit Drill Bit	1/4"	1
728023	Diamond Grit Drill Bit with Water Feature Attachment	1/4"	1
728024	Diamond Grit Drill Bit	9/32"	1
728026	Diamond Grit Drill Bit	5/16"	1
728028	Diamond Grit Drill Bit	3/8"	1
729400	WATER FEATURE ATTACHMENT <1"	<1"	1
729402	Diamond Grit Drill Bit	1/2"	1
729404	Diamond Grit Drill Bit	5/8"	1
729406	Diamond Grit Drill Bit	3/4"	1
729408	Diamond Grit Drill Bit	1"	1
729412	Diamond Grit Drill Bit	1-3/8"	1
729410	Diamond Grit Drill Bit	1-1/4"	1

## QUICK CHANGE GLASS & TILE BITS



Part No	Description	Diameter	Shank	Quantity
728010	Quick Change Glass & Tile Drill Bit	1/8"	1/4" Hex	1
728011	Quick Change Glass & Tile Drill Bit	3/16"	1/4" Hex	1
728012	Quick Change Glass & Tile Drill Bit	1/4"	1/4" Hex	1
728013	Quick Change Glass & Tile Drill Bit	5/16"	1/4" Hex	1
728014	Quick Change Glass & Tile Drill Bit	3/8"	1/4" Hex	1
728015	Quick Change Glass & Tile Drill Bit	1/2"	1/4" Hex	1

## QUICK CHANGE GLASS & TILE BIT SET

Part No	Description	Diameter	Shank	Quantity
728016	4-Piece Quick Change Glass & Tile Drill Bit Set	1/8", 3/16", 1/4", 5/16"	1/4" Hex	4

## 1" SCREWDRIVER BITS



P/N 728339B25

Part Number	Description	Length	Package Qty
728335B10	Phillips #1 Driver bit	1"	10
728336B10	Phillips #2 Driver bit	1"	10
728337B10	Phillips #3 Driver bit	1"	10
728338B10	Robertson #1 Driver bit	1"	10
728339B10	Robertson #2 Driver bit	1"	10
728340B10	Robertson #3 Driver bit	1"	10
728335B25	Phillips #1 Driver bit	1"	25
728336B25	Phillips #2 Driver bit	1"	25
728337B25	Phillips #3 Driver bit	1"	25
728338B25	Robertson #1 Driver bit	1"	25
728339B25	Robertson #2 Driver bit	1"	25
728340B25	Robertson #3 Driver bit	1"	25
728336B250	Phillips #2 Driver bit	1"	250
985336	Slotted #4-5 Driver Bit	1"	1
985337	Slotted #4-6 Driver Bit - Insert Tip with Stepped Rod	1"	1
985338	Slotted #8-10 Insert Tip	1"	1
985339	Slotted #10-12 Insert Tip	1"	1

## 2" SCREWDRIVER BITS



P/N 728351B5

Part Number	Description	Length	Package Qty
728350B2	Phillips #1 Driver bit	2"	2
728351B2	Phillips #2 Driver bit	2"	2
728352B2	Phillips #3 Driver bit	2"	2
728353B2	Robertson #1 Driver bit	2"	2
728354B2	Robertson #2 Driver bit	2"	2
728355B2	Robertson #3 Driver bit	2"	2
728350B5	Phillips #1 Driver bit	2"	5
728351B5	Phillips #2 Driver bit	2"	5
728352B5	Phillips #3 Driver bit	2"	5
728353B5	Robertson #1 Driver bit	2"	5
728354B5	Robertson #2 Driver bit	2"	5
728355B5	Robertson #3 Driver bit	2"	5
992670	Phillips #1 Driver Bit	2"	1
992671	Phillips #2 Driver bit	2"	1
992672	Phillips #3 Driver bit	2"	1
728100	Phillips #1, #2, #3 Driver Bit Set	2"	3
725491	Square Driver Bit	2"	1
955657	Slotted #3-4 Driver Bit	2-3/4"	1
955658	Slotted #4-5 Driver Bit	2"	1
955659	Slotted #4-5 Driver Bit	2-3/4"	1

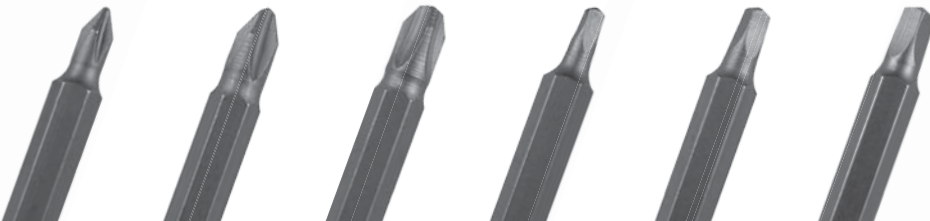

## DOUBLE-ENDED SCREWDRIVER BITS



P/N 728371B5

Part Number	Description	Length	Package Qty
983010	Philips #3 Driver Bit Double Ended	1-3/4"	1
728370B5	Philips #1 Driver Bit Double Ended	2"	5
728371B5	Philips #2 Driver Bit Double Ended	2"	5
728372B5	Philips #3 Driver Bit Double Ended	2"	5
728373B5	Robertson #1 Driver Bit Double Ended	2"	5
728374B5	Robertson #2 Driver Bit Double Ended	2"	5
728375B5	Robertson #3 Driver Bit Double Ended	2"	5
983004	Philips #1 Driver Bit Double Ended	2-3/4"	1
983006	Philips #2 Driver Bit Double Ended	2-1/2"	1
983011	Philips #3 Driver Bit Double Ended	2-1/2"	1

## 3" SCREWDRIVER BITS



P/N 728393B2

Part Number	Description	Length	Package Qty
728390B2	Philips #1 Driver Bit	3"	2
728391B2	Philips #2 Driver Bit	3"	2
728392B2	Philips #3 Driver Bit	3"	2
728393B2	Robertson #1 Driver Bit	3"	2
728394B2	Robertson #2 Driver Bit	3"	2
728395B2	Robertson #3 Driver Bit	3"	2

## 4" SCREWDRIVER BITS



P/N 728412

Part Number	Description	Length	Package Qty
728410	Philips #1 Driver Bit	4"	1
728411	Philips #2 Driver Bit	4"	1
728412	Philips #3 Driver Bit	4"	1
728413	Robertson #1 Driver Bit	4"	1
728414	Robertson #2 Driver Bit	4"	1
728415	Robertson #3 Driver Bit	4"	1

## 6" & 7" SCREWDRIVER BITS



P/N 728435

Part Number	Description	Length	Package Qty
728430	Philips #1 Driver Bit	6"	1
728431	Philips #2 Driver Bit	6"	1
728432	Philips #3 Driver Bit	6"	1
728433	Robertson #1 Driver Bit	6"	1
728434	Robertson #2 Driver Bit	6"	1
728435	Robertson #3 Driver Bit	6"	1
725438	Philips #2 Driver Bit Superdrive	7"	1

Accessories

## MAGNETIC SCREW GUIDES



P/N 728109

Part Number	Description	Length	Package Qty
728109	1/4" Hex Compact Screw Guide	3-1/16"	1
728110	1/4" Hex Standard Screw Guide	4-5/16"	1

## HI-TORQ

Torsion Bits

- Unique design for heavy drilling applications
- Nickel plated for rust prevention
- Hot Cold Hardening process
  - Improves bit strength and life



- Unique metal treatment process uses extreme temperatures to temper the metal for improved performance

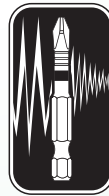

### Shock Resistant Design

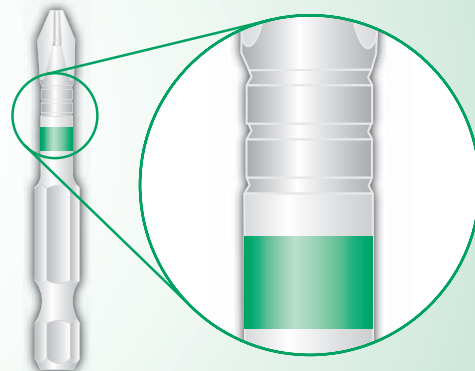

## SCREWDRIVER BIT SETS



P/N 728699



P/N 728698

Part Number	Description	Package Qty
728699	35-Piece Torsion Bit Set - Nickel Plated	35
728698	18-Piece Screwdriver Torsion Bit Set	18
728493	83-Piece Drill and Drive Bit Set	83
799962	120-Piece Drill and Drive Bit Set	120
799961	50-Piece Drill and Drive Bit Set	50

## SUPERDRIVE DRIVER BITS



**PHILLIPS**



Part Number	Description	Size	Length	Type	Quantity
725438	PHILLIPS DRIVER BIT	#2	7"	SuperDrive	1
725439	LOX® DRIVER BIT	#2	7"	SuperDrive	1
725440	LOX® DRIVER BIT	#2	9"	SENCO	1
725441	LOX® DRIVER BIT	#2	5"	SENCO	1
725442	LOX® DRIVER BIT	#2	5-1/2"	PAM	1
725443	LOX® DRIVER BIT	#3	7"	SuperDrive	1
725444	LOX® DRIVER BIT	#3	9"	SENCO	1
725445	LOX® DRIVER BIT	#3	5"	SENCO	1
725446	LOX® DRIVER BIT	#3	5-1/2"	PAM	1
725447	LOX® DRIVER BIT	#2	8"	SENCO	1
725448	LOX® DRIVER BIT	#3	8"	SENCO	1
725449	SQUARE DRIVER BIT	#2	7"	SuperDrive	1
725450	LOX® DRIVER BIT	#2	1"	Insert Tip	1
725451	LOX® DRIVER BIT	#2	1-1/2"	Insert Tip	1
725452	LOX® DRIVER BIT	#2	2"	Power Bit	1
725453	LOX® DRIVER BIT	#2	2-1/2"	Power Bit	1
725454	LOX® DRIVER BIT	#2	3"	Power Bit	1
725455	LOX® DRIVER BIT	#2	3-1/2"	Power Bit	1
725456	LOX® DRIVER BIT	#2	4-1/2"	Power Bit	1
725457	LOX® DRIVER BIT	#2	4-3/4"	PAM	1
725458	LOX® DRIVER BIT	#3	4-3/4"	PAM	1
725459	LOX® DRIVER BIT	#2	6-1/4"	SENCO	1
725460	LOX® DRIVER BIT	#3	6-1/4"	SENCO	1
725462	PHILLIPS DRIVER BIT	#2	5-1/8"	SENCO	1
725463	LOX® DRIVER BIT	#2	5-1/8"	SENCO	1
725464	LOX® DRIVER BIT	#3	5-1/8"	SENCO	1

## SOCKET/HEX/ALLEN HEX DRIVER BITS



P/N 970970

Part Number	Description	Size	Length	Type	Quantity
320560	Socket/Hex/Allen Head Driver Bit	3mm	6"	Power Bit	1
970984	Socket/Hex/Allen Head Driver Bit	4mm	6"	Power Bit	1
970970	Socket/Hex/Allen Head Driver Bit	5mm	2-1/2"	Power Bit	1
970985	Socket/Hex/Allen Head Driver Bit	5mm	9"	Power Bit	1
970971	Socket/Hex/Allen Head Driver Bit	6mm	2-1/2"	Power Bit	1
320561	Socket/Hex/Allen Head Driver Bit	6mm	11"	Power Bit	1
996183	Socket/Hex/Allen Head Driver Bit	8mm	4"	Power Bit	1

## SOCKET/HEX/ALLEN 1/2" SQUARE DRIVER BITS



P/N 970963

Part Number	Description	Size	Length	Type	Quantity
970962	Socket/Hex/Allen Head Driver Bit	10mm	2-1/4"	1/2" Square Drive	1
970963	Socket/Hex/Allen Head Driver Bit	12mm	2-1/4"	1/2" Square Drive	1

Accessories

## 1/4" HEX TO SQUARE DRIVE ADAPTERS



P/N 728586

Part Number	Shank	Drive Size	Finish	Quantity
728585	1/4" Hex Male	1/4" Square Male	Black Oxide	1
728586	1/4" Hex Male	3/8" Square Male	Black Oxide	1
728587	1/4" Hex Male	1/2" Square Male	Black Oxide	1

## SQUARE DRIVE TO 1/4" HEX ADAPTERS



P/N 728589

Part Number	Shank	Drive Size	Finish	Quantity
728588	3/8" Square Female	1/4" Hex Female	Black Oxide	1
728589	1/2" Square Female	1/4" Hex Female	Black Oxide	1

## 1/4" HEX QUICK CHANGE HEX SOCKETS



P/N 985330



P/N 728090

Part Number	Shank	Hex Size	Finish	Finish	Quantity
728095	1/4" Hex	1/4"	M6 Magnetic	Satin	1
985332	1/4" Hex	1/4"	M6 Magnetic	Black Oxide	1
728096	1/4" Hex	5/16"	M8 Magnetic	Satin	1
985322	1/4" Hex	5/16"	M8 Magnetic	Black Oxide	1
996176	1/4" Hex	3/8"	M10 Non-Magnetic	Black Oxide	1
728097	1/4" Hex	3/8"	M10 Magnetic	Satin	1
985330	1/4" Hex	3/8"	M10 Magnetic	Black Oxide	1
996178	1/4" Hex	15/32"	M12 Non-Magnetic	Black Oxide	1
996179	1/4" Hex	1/2"	M13 Non-Magnetic	Black Oxide	1
996180	1/4" Hex	9/16"	M14 Non-Magnetic	Black Oxide	1
996185	1/4" Hex	19/32"	M15 Non-Magnetic	Black Oxide	1
996181	1/4" Hex	5/8"	M16 Non-Magnetic	Black Oxide	1
996186	1/4" Hex	3/4"	M19 Non-Magnetic	Black Oxide	1
309675	1/4" Hex	3/4"	M19 Non-Magnetic	Black Oxide	1
996197	1/4" Hex	3/4"	M21 Non-Magnetic	Black Oxide	1
728098	1/4" Hex 4-Piece Set	7/16", 3/8", 5/16", 1/4"	Magnetic	Satin	4
728094	3/8" Hex Quick Change Connector	1/4"	N/A	N/A	1
728090	1/4" Hex Quick Change 9" Flexible Drive Shaft with Locking Collar	1/4"	N/A	N/A	1

## DEPTH OF DRIVE ATTACHMENT



P/N 310395

Part Number	Driver Bit Length	Applicable Bits					
		PH#1	PH#2	PH#3	LOX#2	5mm Hex	6mm Hex
310395	2-1/2"	983004	983006	983011	725453	970970	970971

## BIT TIP HOLDERS



P/N 98254Z

Part Number	Description	Shank	Length	Quantity
982563Z	Non-Magnetic Bit Holder	1/4" Hex	2-9/16"	1
982554Z	Magnetic Bit Holder	1/4" Hex	2-9/16"	1
728115	Magnetic Bit Holder Extension	1/4" Hex	3"	1
728116	Magnetic Bit Holder Extension	1/4" Hex	6"	1

## "HIGH TORQUE" IMPACT SOCKETS

- INCREASED TORQUE**  
 High quality alloy steel (chrome-molybdenum) allows up to 20% more torque to be applied than on standard Chrome-Vanadium sockets.
- EASIER ACCESS TO TIGHT AREAS**  
 Hitachi impact sockets incorporate a thin wall design that increases access to tight areas.
- REDUCED WEAR**  
 Sockets grip the fastener across a broader contact area, reducing the chance of rounding of fasteners.
  - Includes durable metal case or metal clip organizer
  - Works in all drills, impact drivers and wrenches



**INCREASED STRENGTH**

Transfers the pressure from the thinnest part of the socket wall toward the thicker section, resulting in increased strength.

**FRACTIONAL 6 POINT SOCKET SHAPES**

**A**

I

**A** Narrow at top

**B**

II

**B** Straight all the way

**C**

III

**C** Narrow at base

## 3/8" DRIVE STANDARD LENGTH



P/N 728511

Part Number	Description	Width	Length	Shape	Quantity
728501	3/8" Square Female Drive 6 Points Impact Socket	5/16"	1-3/16"	I	1
728502	3/8" Square Female Drive 6 Points Impact Socket	3/8"	1-3/16"	I	1
728503	3/8" Square Female Drive 6 Points Impact Socket	7/16"	1-3/16"	I	1
728504	3/8" Square Female Drive 6 Points Impact Socket	1/2"	1-3/16"	II	1
728505	3/8" Square Female Drive 6 Points Impact Socket	9/16"	1-3/16"	II	1
728506	3/8" Square Female Drive 6 Points Impact Socket	5/8"	1-3/16"	II	1
728507	3/8" Square Female Drive 6 Points Impact Socket	11/16"	1-3/16"	II	1
728508	3/8" Square Female Drive 6 Points Impact Socket	3/4"	1-3/16"	II	1
728509	3/8" Square Female Drive 6 Points Impact Socket	13/16"	1-3/16"	II	1
728510	3/8" Square Female Drive 6 Points Impact Socket	7/8"	1-3/16"	II	1
728511	3/8" Square Female Drive 6 Points Impact Socket	15/16"	1-3/16"	II	1
728512	3/8" Square Female Drive 6 Points Impact Socket	1"	1-3/16"	II	1

## 3/8" DRIVE DEEP LENGTH



P/N 728526

Part Number	Description	Width	Length	Shape	Quantity
728516	3/8" Square Female Drive 6 Points Impact Socket	5/16"	2-1/2"	I	1
728517	3/8" Square Female Drive 6 Points Impact Socket	3/8"	2-1/2"	I	1
728518	3/8" Square Female Drive 6 Points Impact Socket	7/16"	2-1/2"	I	1
728519	3/8" Square Female Drive 6 Points Impact Socket	1/2"	2-1/2"	II	1
728520	3/8" Square Female Drive 6 Points Impact Socket	9/16"	2-1/2"	II	1
728521	3/8" Square Female Drive 6 Points Impact Socket	5/8"	2-1/2"	II	1
728522	3/8" Square Female Drive 6 Points Impact Socket	11/16"	2-1/2"	II	1
728523	3/8" Square Female Drive 6 Points Impact Socket	3/4"	2-1/2"	II	1
728524	3/8" Square Female Drive 6 Points Impact Socket	13/16"	2-1/2"	II	1
728525	3/8" Square Female Drive 6 Points Impact Socket	7/8"	2-1/2"	II	1
728526	3/8" Square Female Drive 6 Points Impact Socket	15/16"	2-1/2"	II	1
728527	3/8" Square Female Drive 6 Points Impact Socket	1"	2-1/2"	II	1

Accessories

## 1/2" DRIVE STANDARD LENGTH



P/N 728539

Part Number	Description	Width	Length	Shape	Quantity
944291	1/2" Square Female Drive 6 Points Impact Socket	3/8"	1-9/16"	I	1
728531	1/2" Square Female Drive 6 Points Impact Socket	7/16"	1-1/2"	I	1
728532	1/2" Square Female Drive 6 Points Impact Socket	1/2"	1-9/16"	I	1
728533	1/2" Square Female Drive 6 Points Impact Socket	9/16"	1-1/2"	I	1
728534	1/2" Square Female Drive 6 Points Impact Socket	5/8"	1-1/2"	II	1
728535	1/2" Square Female Drive 6 Points Impact Socket	11/16"	1-1/2"	II	1
728536	1/2" Square Female Drive 6 Points Impact Socket	3/4"	1-1/2"	II	1
728537	1/2" Square Female Drive 6 Points Impact Socket	13/16"	1-1/2"	II	1
728538	1/2" Square Female Drive 6 Points Impact Socket	7/8"	1-1/2"	II	1
728539	1/2" Square Female Drive 6 Points Impact Socket	15/16"	1-1/2"	II	1
728540	1/2" Square Female Drive 6 Points Impact Socket	1"	1-1/2"	II	1
728541	1/2" Square Female Drive 6 Points Impact Socket	1-1/16"	1-1/2"	II	1
728542	1/2" Square Female Drive 6 Points Impact Socket	1-1/8"	1-1/2"	II	1
728543	1/2" Square Female Drive 6 Points Impact Socket	1-1/4"	1-1/2"	II	1

## 1/2" DRIVE DEEP LENGTH



P/N 728555

Part Number	Description	Width	Length	Shape	Quantity
728546	1/2" Square Female Drive 6 Points Impact Sockets	7/16"	3-1/4"	I	1
728547	1/2" Square Female Drive 6 Points Impact Sockets	1/2"	3-1/4"	I	1
728548	1/2" Square Female Drive 6 Points Impact Sockets	9/16"	3-1/4"	I	1
728549	1/2" Square Female Drive 6 Points Impact Sockets	5/8"	3-1/4"	II	1
728550	1/2" Square Female Drive 6 Points Impact Sockets	11/16"	3-1/4"	II	1
728551	1/2" Square Female Drive 6 Points Impact Sockets	3/4"	3-1/4"	II	1
728552	1/2" Square Female Drive 6 Points Impact Sockets	13/16"	3-1/2"	II	1
728553	1/2" Square Female Drive 6 Points Impact Sockets	7/8"	3-1/2"	II	1
728554	1/2" Square Female Drive 6 Points Impact Sockets	15/16"	3-1/2"	II	1
728555	1/2" Square Female Drive 6 Points Impact Sockets	1"	3-1/2"	II	1
728556	1/2" Square Female Drive 6 Points Impact Sockets	1-1/16"	3-1/2"	II	1
728557	1/2" Square Female Drive 6 Points Impact Sockets	1-1/8"	3-1/2"	III	1
728558	1/2" Square Female Drive 6 Points Impact Sockets	1-1/4"	3-1/2"	III	1

## 3/4" DRIVE STANDARD LENGTH



P/N 728561

Part Number	Description	Width	Length	Shape	Quantity
874527	3/4" Square Female Drive 6 Points Impact Socket	15/16"	1-9/16"	I	1
874528	3/4" Square Female Drive 6 Points Impact Socket	15/16"	1-9/16"	I	1
728561	3/4" Square Female Drive 6 Points Impact Socket	1"	2-1/8"	III	1
728562	3/4" Square Female Drive 6 Points Impact Socket	1-1/16"	2-1/8"	III	1
728563	3/4" Square Female Drive 6 Points Impact Socket	1-1/8"	2-1/8"	II	1
728564	3/4" Square Female Drive 6 Points Impact Socket	1-1/4"	2-1/8"	II	1
728565	3/4" Square Female Drive 6 Points Impact Socket	1-5/16"	2-1/4"	III	1
728566	3/4" Square Female Drive 6 Points Impact Socket	1-3/8"	2-1/4"	III	1
728567	3/4" Square Female Drive 6 Points Impact Socket	1-7/16"	2-1/4"	III	1
728568	3/4" Square Female Drive 6 Points Impact Socket	1-1/2"	2-1/4"	III	1



## 3/4" DRIVE DEEP LENGTH



P/N 728571

Part Number	Description	Width	Length	Shape	Quantity
728571	3/4" Square Female Drive 6 Points Impact Socket	1"	3-1/2"	III	1
728572	3/4" Square Female Drive 6 Points Impact Socket	1-1/16"	3-1/2"	III	1
728573	3/4" Square Female Drive 6 Points Impact Socket	1-1/8"	3-1/2"	II	1
728574	3/4" Square Female Drive 6 Points Impact Socket	1-1/4"	3-1/2"	III	1
728575	3/4" Square Female Drive 6 Points Impact Socket	1-5/16"	3-1/2"	III	1
728576	3/4" Square Female Drive 6 Points Impact Socket	1-3/8"	3-1/2"	III	1
728577	3/4" Square Female Drive 6 Points Impact Socket	1-7/16"	3-1/2"	III	1
728578	3/4" Square Female Drive 6 Points Impact Socket	1-1/2"	3-3/4"	III	1

## IMPACT SOCKET SETS



P/N 728530



P/N 728570

Part Number	Description	Drive	Length	Includes
728500	13-Piece Impact Socket Set	3/8" Square	Standard	5/16", 3/8", 7/16", 1/2", 9/16", 5/8", 11/16", 3/4", 13/16", 7/8", 15/16", 1" + 3/8" Square Drive to 1/4" Hex Adapter, Clip Rail
728515	12-Piece Impact Socket Set	3/8" Square	Deep	5/16", 3/8", 7/16", 1/2", 9/16", 5/8", 11/16", 3/4", 13/16", 7/8", 15/16", 1" + Metal Case
728530	14-Piece Impact Socket Set	1/2" Square	Standard	7/16", 1/2", 9/16", 5/8", 11/16", 3/4", 13/16", 7/8", 15/16", 1", 1-1/16", 1-1/8", 1-1/4" + 1/2" Drive Female to 1/4" Hex Female Adapter + Clip Rail
728545	13-Piece Impact Socket Set	1/2" Square	Deep	7/16", 1/2", 9/16", 5/8", 11/16", 3/4", 13/16", 7/8", 15/16", 1", 1-1/16", 1-1/8", 1-1/4" + Metal Case
728560	8-Piece Impact Socket Set	3/4" Square	Standard	1", 1-1/16", 1-1/8", 1-1/4", 1-5/16", 1-3/8", 1-7/16", 1-1/2" + Metal Case
728570	8-Piece Impact Socket Set	3/4" Square	Deep	1", 1-1/16", 1-1/8", 1-1/4", 1-5/16", 1-3/8", 1-7/16", 1-1/2" + Metal Case

## IMPACT SOCKET ADAPTERS



P/N 728589



P/N 992610



P/N 728584



P/N 955153

Part Number	Description	Length	From	To	Quantity
728585	Adapter	2"	1/4" Hex Male	1/4" Square Male	1
728586	Adapter	2"	1/4" Hex Male	3/8" Square Male	1
728587	Adapter	2"	1/4" Hex Male	1/2" Square Male	1
728580	Adapter w/ Friction Ball	1-1/4"	3/8" Square Female	1/4" Square Male	1
728581	Adapter w/ Friction Ball	1-1/2"	3/8" Square Female	1/2" Square Male	1
728588	Adapter	1-9/16"	3/8" Square Female	1/4" Hex Female	1
728582	Adapter w/ Friction Ball	1-1/2"	1/2" Square Female	3/8" Square Male	1
873633	1/2" Drive x 3" Extension with Locking Pin.	4"	1/2" Square Female	1/2" Square Male	1
728583	Adapter w/ Friction Ball	2"	1/2" Square Female	3/4" Square Male	1
728589	Adapter	2"	1/2" Square Female	1/4" Hex Female	1
992610	Uni-Joint Adapter	1" x 1-1/2" Uni-Joint	1/2" Square Female	1/2" Square Male	1
728584	Adapter w/ Friction Ball	2-1/4"	3/4" Square Female	1/2" Square Male	1
874535	Adapter	6"	3/4" Square Female	3/8" Square Male	1
955088	Uni-Joint Adapter	1-1/4" x 2-1/2" Uni-Joint	3/4" Square Female	3/8" Square Male	1
955038	3/4" Drive x 32mm Deep Socket	4"	3/4" Square		1
873537	Socket Pin	2" x 1/8"			1
996163	Socket Pin	13/16" x 3/16"			1
874524	Socket Ring	1-1/2" x 1-1/2"			1
874525	Socket Pin	2-1/2" x 3/16"			1
955153	Socket Pin for Uni-Joint	2" x 1/4"			1

Accessories

## Chucks

**Keyless** drill chucks in metal or plastic design with radial locking, for corded and cordless drills, for hammer drilling, with hexagon for assembling and disassembling on the machine spindle.

**Key-type** drill chucks with key, for drills with higher frequency we recommend key-type drill chuck.

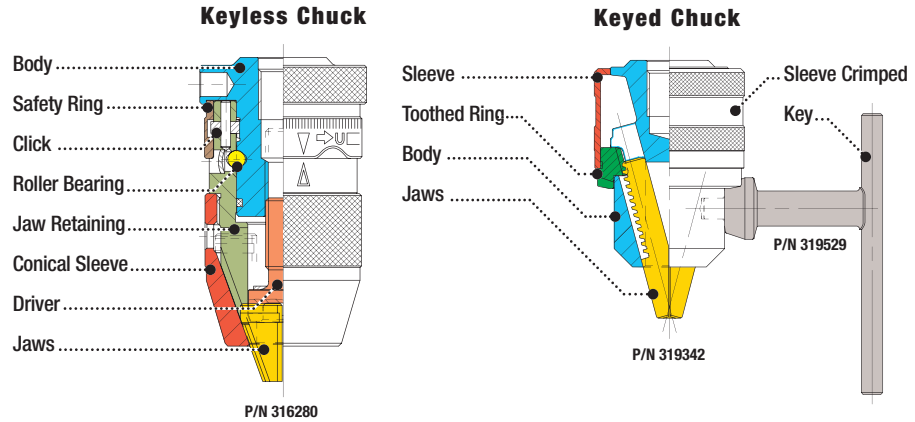

## 3/8" DRILL CHUCKS



Part Number	Description	Capacity	Thread	Chuck Key
316260	Plastic Keyless	1/32" - 3/8" (0.8 - 10mm)	1/2"-20THD	N/A
318835	Metal Keyed, Low Profile	3/8" (10mm)	3/8"-24THD	319070
319342	Metal Keyed	1/32" - 3/8" (0.8 - 10mm)	1/2"-20THD	319529
321812	Metal Keyed	1/32" - 3/8" (0.8 - 10mm)	1/2"-20THD	303334
321870	Plastic Keyless, Hammer Drill	1/32" - 3/8" (0.8 - 10mm)	3/8"-24THD	N/A
950292	Metal Keyed	3/8" (10mm)	3/8"-24THD	319070
725407	Plastic Keyless	3/8" (10mm)	3/8"-24THD	N/A

## 1/2" DRILL CHUCKS



Part Number	Description	Capacity	Thread	Chuck Key
315133	Plastic Keyless	1/16" - 1/2" (1.5 - 13mm)	1/2"-20THD	N/A
315966	Plastic Keyless, Hammer Drill	1/16" - 1/2" (1.5 - 13mm)	1/2"-20THD	N/A
316280	Metal Keyless, Hammer Drill	1/16" - 1/2" (1.5 - 13mm)	1/2"-20THD	N/A
319303	Metal Keyed	1/16" - 1/2" (1.5 - 13mm)	1/2"-20THD	319527
319304	Plastic Keyless	1/16" - 1/2" (1.5 - 13mm)	1/2"-20THD	N/A
319546	Metal Keyless, Hammer Drill	1/16" - 1/2" (1.5 - 13mm)	1/2"-20THD	N/A
320684	Plastic Keyless, Hammer Drill	1/16" - 1/2" (1.5 - 13mm)	1/2"-20THD	N/A
321814	Metal Keyed	1/16" - 1/2" (1.5 - 13mm)	1/2"-20THD	303334
321816	Metal Keyed	1/16" - 1/2" (1.5 - 13mm)	5/8"-16THD	930515
322357	Metal Keyless	1/16" - 1/2" (1.5 - 13mm)	1/2"-20THD	N/A
323000	Metal Keyless	1/16" - 1/2" (1.5 - 13mm)	1/2"-20THD	N/A
324205	Plastic Keyless	1/16" - 1/2" (1.5 - 13mm)	1/2"-20THD	N/A

## 5/8" DRILL CHUCKS

Part Number	Description	Capacity	Thread	Chuck Key
726471	Metal Keyed	1/16" - 5/8" (1.5 - 16mm)	J3 Taper Mount	726297*

\* Spring Loaded

## 1/4" HEX DRIVE DRILL CHUCKS & ADAPTERS



Part Number	Description	Capacity	Thread	Chuck Key
321843	Metal Keyed	1/16" - 1/2" (1.5 - 13mm)	1/4" Hex to 3/8"-24THD	930119
725405	Plastic Keyless, High Torque	3/8" (10mm)		N/A
725796	Adapter	N/A	1/4" Hex to 3/8"-24THD	N/A
307543	Adapter	N/A	1/4" Hex to 1/2"-20THD	N/A

## ROTARY HAMMER DRILL CHUCKS & ADAPTERS



Part Number	Description	Capacity	Thread	Chuck Key
303332	Metal Keyed, Hammer Drill Mode	1/2" (13mm)	SDS+ to 1/2"-20THD	303334
303820	Metal Keyed, Drilling Only Mode	1/2" (13mm)	SDS+ to 1/2"-20THD	303334
725797	Adapter	N/A	Spline to 1/2"-20THD	N/A
725798	Adapter	N/A	SDS Max to 1/2"-20THD	N/A
725792	Adapter	N/A	SDS+ to 1/2"-20THD	N/A

## MISC. CHUCK ACCESSORIES



















P/N 319528

Part Number	Description
319527	Drill Chuck Wrench K32
319528	Angle Drilling Attachment Assembly
319529	Drill Chuck Wrench K30
319070	Drill Chuck Wrench KG1
327488	Metal Keyed Drill Chuck and Key
726297	Drill Chuck Wrench S3
930119	Drill Chuck Wrench 6.5G/10
930733	Drill Chuck Wrench 13G S3
950288	Vinyl Band for Drill Chuck Key (Wrench)
303334	Drill Chuck Wrench S2A



## Shanks

		<b>Spline</b>		
<b>Straight</b>				
		<b>3/4" Hex/Round</b>		
<b>SDS-Plus</b>				
		<b>3/4" Hex</b>		
<b>SDS-Max</b>		<b>1-1/8" Hex</b>		

## 4-Plus Drill Bits

**Modern Tip Brazing Technique** ..... delivers high life expectancy and substantially improved resistance when hitting on rebar.

**Aggressive Carbide Tip Edge** ..... with centering point prevents bit walking and penetrates on contact.

**Precision Tip** ..... of industrial quality carbide for extremely tough materials.

**Ground From Solid** ..... unique "H"-shape reinforced flute for fast dust and debris removal.

**Thermal Treatment** ..... and a special surface finish reduce the wear of the bit and improve its resistance against bending force.

**Hardened and Heat Treated** ..... premium alloy steel ensures hammering quality and long life.

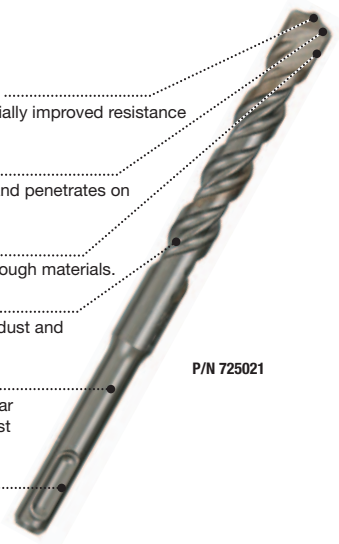

P/N 725021

## ProPlus 2-Cutter Drill Bits

**Dynamic, Chisel-Shaped Drill Bit Head** ..... penetrates fast in the material and transports drilling dust in the multi-flute spiral. Robust carbide geometry prevents chipping.

**130° Tip Angle** ..... for easy spot drilling and precise anchor holes.

**Tough Soldered Joints** ..... between carbide and steel are optimized to avoid breakage of the carbide tip.

**Deep and Wide Slots** ..... support the carbide tip to avoid breakage of the supporting steel.

**High-Volume Twin Flute** ..... for fast debris removal.

**Special Surface Finish** ..... for reduced drill bit wear.

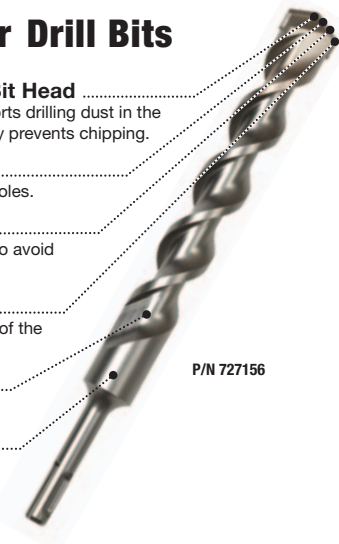

P/N 727156

## QuadPlus 4-Cutter Drill Bits

**Centering Tip** ..... for easy alignment for pinpoint accuracy and fast starts.

**Short and Wide Dust Entrances** ..... quickly and efficiently channel dust and debris from the drill bit tip resulting in less wear and heat build up.

**4 x 90° Head Symmetry** ..... for low vibration which results in perfectly symmetrical holes for easy anchor applications. Additionally, bit won't stick when contacting rebar.

**One-Piece Embedded Carbide Element with Four Chamfered Edges** ..... improves bit life and breakage resistance resulting in optimal drilling performance in reinforced concrete.

**Four Fluted, Spiral Geometry** ..... equally distributes work load reducing flute wear, while optimized core strength ensures impact durability.



P/N 725677



## ZENTRO 4 Cutter Drill Bits

**Symmetrically Designed 4 Cutter Head** ..... with centering point tip geometry allows spot drilling and provides centric guidance.

**Secondary Cutters** ..... protect drill bit in the event of reinforcement collision.

**Short Dust Entrances** ..... and large volume spiral flutes provide rapid dust removal.

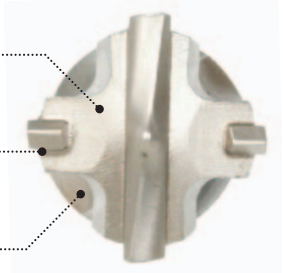

## 3 Cutter Drill Bits

**Solid Carbide Head** ..... produces near-perfect round holes for improved anchoring.

**Solid Triple Edge Carbide Tip** ..... reduces bit locking when drilling through rebar reinforced concrete.

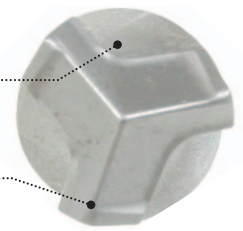

## 2 Cutter Drill Bits

**Aggressive and Durable** ..... carbide tip allows easy centering and fast drilling.

**Dynamic** ..... chisel-shaped bit head ensures rapid penetration.

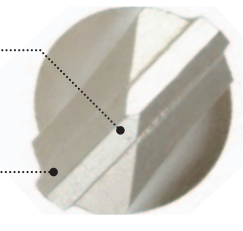

## Straight Shank

For use with corded and cordless hammer drills and light rotary hammer drills with 3-jaw-chuck. High-performance drill bits with specially developed tip and flute geometry for hammer drilling in brick, mortar, cinder block and soft concrete.

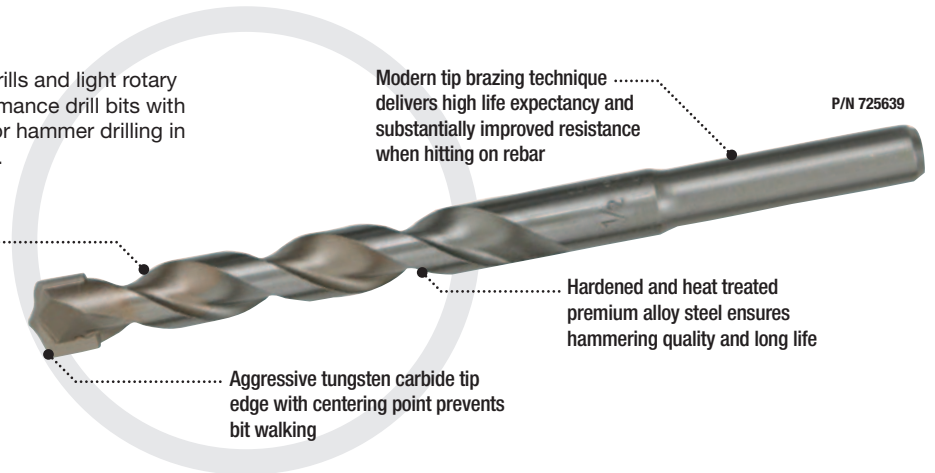

## STRAIGHT SHANK HAMMER DRILL BITS

### 2-Cutter Drill Bits



P/N 725600

Part Number		Diameter	Drilling Depth	Total Length
Each	5 Pack			
	725600	3/16", 1/4", 5/16", 3/8", 1/2"	4"	6"
	725601	5/32", 3/16"	4"	6"
725621*	725621B*	1/8"	1-3/8"	3"
725622		5/32"	4"	6"
725623	725623B	3/16"	1-9/16"	3-1/2"
725624	725624B	3/16"	4"	6"
725625		7/32"	4"	6"
725626	725626B	1/4"	2-1/8"	4"
725627	725627B	1/4"	4"	6"
725628		1/4"	10"	12"
725629		1/4"	22"	24"
725630*		9/32"	2-1/8"	4"
725631	725631B	5/16"	2-3/4"	4-3/4"
725632	725632B	5/16"	4"	6"
725633		5/16"	10"	12"
725634	725634B	3/8"	4"	6"
725635	725635B	3/8"	10"	12"
725636		3/8"	18"	20"
725637		3/8"	22"	24"
725638*		7/16"	4"	6"
725639	725639B	1/2"	4"	6"
725640	725640B	1/2"	10"	12"
725641		1/2"	18"	20"
725642		1/2"	22"	24"
725643*		9/16"	3-1/2"	6"
725644		5/8"	3-1/2"	6"
725645		5/8"	10"	12"
725646		5/8"	22"	24"
725647		3/4"	4"	6"
725648*		3/4"	10"	12"
725649*		7/8"	4"	6"
725650*		7/8"	10"	12"
725651*		1"	4"	6"
725652*		1"	10"	12"
725653*		1"	22"	24"

\* With standard carbide tip.  
Drill bits with diameters larger than 15/32" and lengths of 12" upwards are supplied with a 3-flat shank.

Accessories

## SDS-Plus

For use in concrete, masonry and natural stone.

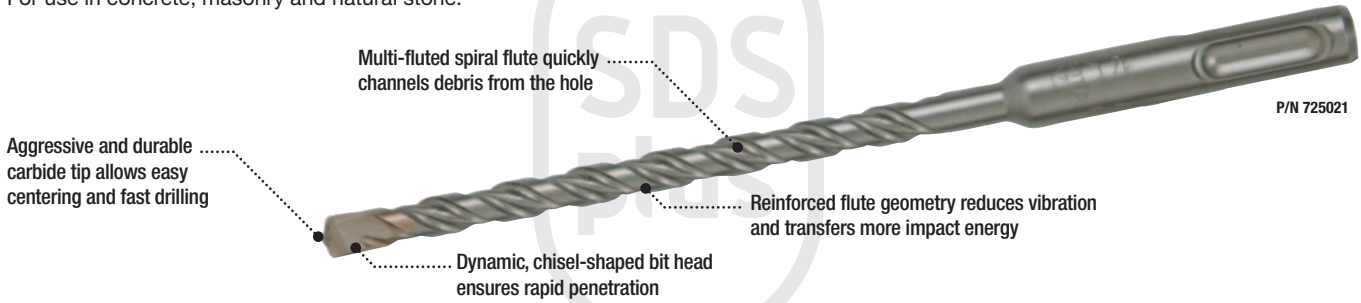

## SDS-PLUS DRILL BITS

### 2-Cutter Drill Bits



	Part Number			Diameter	Drilling Depth	Total Length
	Each	20 Pack	25 Pack			
728870				5/32"	2"	4-1/4"
725010			725010B	5/32"	4"	6-1/4"
725008			725008B	3/16"	2"	4-1/2"
725011			725011B	3/16"	4"	6-1/4"
725012			725012B	3/16"	6"	8-1/4"
725013			725013B	3/16"	8"	10"
725014			725014B	3/16"	10"	12"
725015			725015B	3/16"	12"	14"
728871				3/16"	14"	16"
725016			725016B	7/32"	4"	6-1/4"
725017			725017B	7/32"	6"	8-1/4"
725018			725018B	7/32"	9"	11"
725019				7/32"	12"	14"
725020			725020B	7/32"	14"	16"
725133			725133B	1/4"	2"	4-1/2"
725021			725021B	1/4"	4"	6-1/4"
725022			725022B	1/4"	6"	8-1/4"
725023				1/4"	9"	11"
725024			725024B	1/4"	12"	14"
725025				1/4"	14"	16"
725026				1/4"	18"	20"
725027			725027B	5/16"	4"	6-1/4"
725028				5/16"	10"	12"
725029			725029B	3/8"	4"	6-1/4"
725030			725030B	3/8"	6"	8-1/4"
725065				3/8"	8"	10-1/4"
725031			725031B	3/8"	10"	12-1/4"
725032				3/8"	16"	18"
725033				3/8"	22"	24"
725034				7/16"	4"	6-1/4"
725035				7/16"	10"	12-1/4"
728872				7/16"	16"	18"
725036		725036B		1/2"	4"	6-1/4"
725037				1/2"	8"	10-1/4"
725038		725038B		1/2"	10"	12-1/4"
725039				1/2"	16"	18"
725040				1/2"	22"	24"
725041				9/16"	4"	6-1/4"
725042				9/16"	8"	10-1/4"

## SDS-PLUS DRILL BITS

### 2-Cutter Drill Bits (cont.)



P/N 725611

	Part Number			Diameter	Drilling Depth	Total Length
	Each	5 Pack	15 Pack			
728873				9/16"	10"	12-1/4"
728874				9/16"	16"	18"
725200				5/8"	4"	6-1/4"
725043			725043B	5/8"	6"	8"
725044				5/8"	10"	12"
725045				5/8"	16"	18"
728875				5/8"	22"	24"
725046				11/16"	6"	8"
725047				11/16"	10"	12"
725049				3/4"	6"	8"
728876				3/4"	8"	10"
725050				3/4"	10"	12"
725051				3/4"	16"	18"
728877				3/4"	22"	24"
728866				13/16"	16"	18"
728878				27/32"	6"	8"
725052				7/8"	6"	8"
728879				7/8"	8"	10"
725053				7/8"	10"	12-1/2"
725054				7/8"	16"	18"
725055				1"	6"	8"
725056				1"	8"	10"
725057				1"	10"	12"
725058				1"	16"	18"
		725611		3/16", 1/4", 5/16", 3/8", 1/2"		

## SDS-PLUS DRILL BITS

### 2-Cutter Drill Bit



P/N 727156

	Part Number				Diameter	Drilling Depth	Total Length
	Each	8 Pack	10 Pack	20 Pack			
727109				727109B20	5/32"	2"	4"
727110				727110B20	5/32"	4"	6"
727111				727111B20	3/16"	2"	4"
727112				727112B20	3/16"	4"	6"
727113				727113B20	3/16"	6"	8"
727120				727120B20	1/4"	2"	4"
727121				727121B20	1/4"	4"	6"
727122				727122B20	1/4"	6"	8"
727127				727127B20	5/16"	4"	6"
727129				727129B20	3/8"	4"	6"
727131				727131B20	3/8"	10"	12"
727136				727136B20	1/2"	4"	6"
727138				727138B20	1/2"	10"	12"
727141				727141B20	9/16"	4"	6"
727143				727143B10	5/8"	6"	8"
727144				727144B10	5/8"	10"	12"
727149				727149B10	3/4"	6"	8"
727150				727150B10	3/4"	10"	12"
727152				727152B10	7/8"	6"	8"
727153				727153B10	7/8"	10"	12"
727156		727156B8			1"	8"	10"

Accessories

## SDS-PLUS DRILL BITS

### 2-Cutter Hex Drill Bits

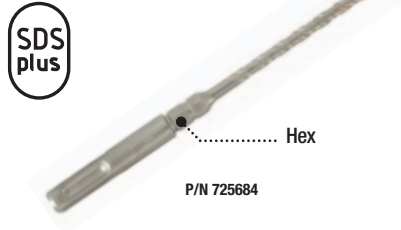

SDS plus

	Part Number			Diameter	Drilling Depth	Total Length
	Each	5 Pack	25 Pack			
725680				5/32"	2-3/8"	5"
725681				5/32"	3-1/8"	6"
725682			725682B25	5/32"	4-1/8"	7"
725683				3/16"	2-3/4"	5"
725684				3/16"	3-1/8"	6"
725685			725685B25	3/16"	4-1/8"	7"
		725615		5/32", 3/16"	Various	Various

## SDS-PLUS DRILL BITS

### 3-Cutter Drill Bits



SDS plus

Part Number	Diameter	Drilling Depth	Total Length
728881	5/32"	4"	6"
728883	3/16"	4"	6"
728884	3/16"	6"	8"
728886	1/4"	2"	4"
728887	1/4"	4"	6"
728888	1/4"	6"	8"
728890	5/16"	4"	6"
728892	3/8"	4"	6"
728893	3/8"	6"	8"
728894	3/8"	10"	12"
728897	1/2"	4"	6"
728898	1/2"	10"	12"

## SDS-PLUS DRILL BITS

### 4-Cutter Drill Bits



SDS plus

ZENTRO

Part Number	Diameter	Drilling Depth	Total Length
728910	5/8"	6"	8"
728911	5/8"	8"	10"
728912	5/8"	10"	12"
728913	5/8"	16"	18"
728915	11/16"	8"	10"
728916	11/16"	10"	12"
728917	11/16"	16"	18"
728919	3/4"	6"	8"
728920	3/4"	8"	10"
728921	3/4"	10"	12"
728922	3/4"	16"	18"
728923	3/4"	22"	24"
728925	27/32"	8"	10"
728927	7/8"	6"	8"
728928	7/8"	8"	10"
728929	7/8"	10"	12"
728930	7/8"	16"	18"
728932	1"	6"	8"
728933	1"	8"	10"
728934	1"	10"	12"
728935	1"	16"	18"
728937	1-7/64"	16"	18"
728939	1-1/8"	8"	10"
728940	1-1/8"	16"	18"
728942	1-3/16"	8"	10"
728943	1-3/16"	16"	18"
728945	1-1/4"	16"	18"



## WHETHER YOU'RE DRILLING

into concrete alone or reinforced concrete material with rebar, Four-Cutter Quad Plus Bits from Hitachi have you covered.

### all the small diameter sizes you need

Hitachi's line of Quad Plus Four-Cutter bits are available in a wide range of small diameters including: 3/16", 1/4", 5/16", 3/8", 7/16", 1/2" and 9/16".

### better design leads to longer bit life

#### the tip

The quad imprint is precisely beveled and grooved deep into the end of the high strength steel. This provides more surface area for the one-piece Carbide bit tip with centering point to adhere securely to the steel, adding strength and durability.

#### the flutes

Four edges on the Quad Plus bit tip lead easily into the uniform channels that spiral down the length of the bit. These channels are wider, deeper and consistently spaced, as compared to competitive four-cutter bits. They allow the debris to efficiently move up and away from the tip at a higher volume, reducing heat, vibration and wear and tear on the bit itself.

#### the core

The core is carefully designed and constructed to maximize the strength of the steel bit. A cross section of the bit shows that the spacing between the channels are consistently uniform and the diameter of the core between the thinnest parts of the spiral grooves are thicker, as compared to competitive four-cutter bits. This uniformity and support throughout the center of the bit ensures break resistance and longer bit life.



### Quad Plus Four-Cutter Bits from Hitachi:

- Drill approximately 50% more holes than two-cutter bits
- Produce less vibration
- Remove debris faster
- Resist breakage
- Stick less in reinforced concrete
- Can be used in concrete and masonry as well as in reinforced concrete for even more value and flexibility

## SDS-PLUS DRILL BITS

### Reinforced Concrete Cutter



## Quad Plus



	Part Number				Diameter	Drilling Depth	Total Length
	Each	5 Pack	10 Pack	15 Pack			
725655				725655B15	3/16"	2"	4"
725656				725656B15	3/16"	4"	6"
725657				725657B15	3/16"	6"	8"
725658				725658B15	3/16"	8"	10"
725659				725659B15	3/16"	10"	12"
725660				725660B15	1/4"	2"	4"
725661				725661B15	1/4"	4"	6"
725662				725662B15	1/4"	6"	8"
725663				725663B15	1/4"	8"	10"
725664				725664B15	1/4"	10"	12"
725665				725665B15	5/16"	4"	6"
725666				725666B15	5/16"	10"	12"
725667			725667B10		5/16"	16"	18"
725668			725668B10		3/8"	4"	6"
725669			725669B10		3/8"	10"	12"
725670			725670B10		3/8"	16"	18"
725671			725671B10		7/16"	4"	6"
725672			725672B10		7/16"	10"	12"
725673			725673B10		7/16"	16"	18"
725674			725674B10		1/2"	4"	6"
725675			725675B10		1/2"	10"	12"
725676	725676B5				1/2"	16"	18"
725677	725677B5				9/16"	4"	6"
725678	725678B5				9/16"	10"	12"
725679	725679B5				9/16"	16"	18"

Accessories

## SDS-Max

For use in concrete, masonry and natural stone.

Aggressive and durable carbide tip allows easy centering and fast drilling. Dynamic tip geometry enhances hole roundness and rebar cutting.

Multi-fluted spiral flute quickly channels debris from the hole.

Reinforced core flute for maximum energy transfer.

Reinforced flute geometry reduces vibration.

P/N 724986

## SDS-MAX DRILL BITS

### 2-Cutter Drill Bits



P/N 724970

Part Number	Diameter	Drilling Depth	Total Length
724970	1/2"	7-1/2"	13"
724971	1/2"	15-1/2"	21"
728960	1/2"	24"	28"
728961	1/2"	31"	36"
724972	9/16"	7-1/2"	13"
724973	9/16"	15-1/2"	21"





## SDS-MAX DRILL BITS

### 4-Cutter Drill Bits



P/N 724986

Part Number	Diameter	Drilling Depth	Total Length
724974	5/8"	7-1/2"	13"
724975	5/8"	15-1/2"	21"
724976	5/8"	30-1/2"	36"
724977	11/16"	15-1/2"	21"
724978	3/4"	8"	13"
724979	3/4"	17"	21"
724980	3/4"	31"	36"
724981	13/16"	17"	21"
728965	27/32"	8"	13"
724982	27/32"	17"	21"
724983	7/8"	8"	13"
724984	7/8"	17"	21"
728967	7/8"	31"	36"
724985	1"	8"	13"
724986	1"	17"	21"
724987	1"	31"	36"
724988	1-1/16"	18"	23"
724989	1-1/8"	12"	17"
724990	1-1/8"	17"	21"
728969	1-1/8"	31"	36"
728970	1-3/16"	18"	23"
724991	1-1/4"	10"	15"
724992	1-1/4"	18"	23"
724993	1-1/4"	31"	36"
724994	1-3/8"	18"	23"
728972	1-3/8"	31"	36"
724995	1-7/16"	18"	23"
728974	1-1/2"	12"	17"
724996	1-1/2"	18"	23"
724997	1-9/16"	18"	23"
724998	1-3/4"	18"	23"
724999	2"	18"	23"

Accessories

## Spline Shank

For use in concrete, masonry and natural stone.

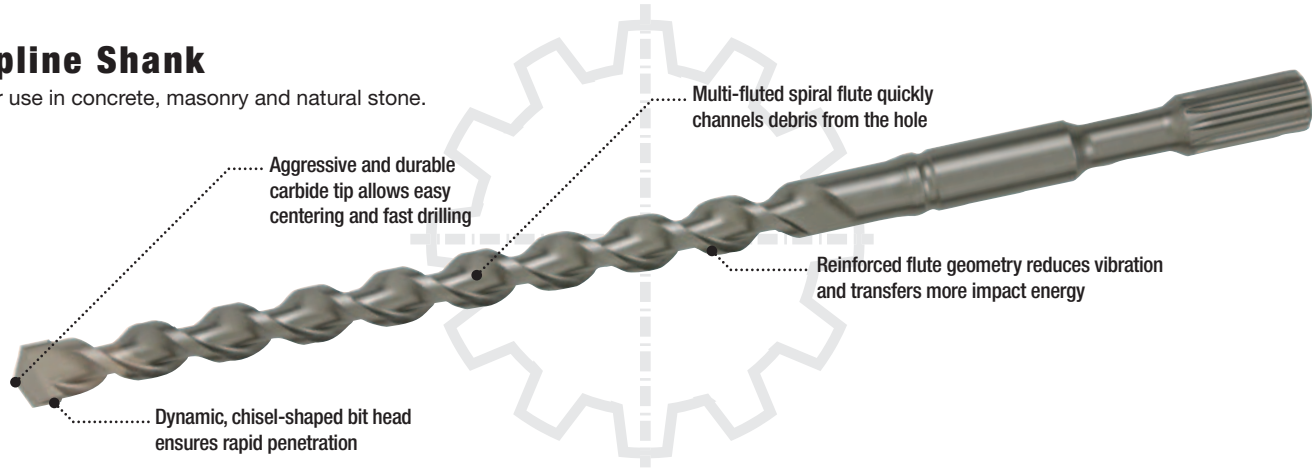

## SPLINE DRILL BITS

### 2-Cutter Drill Bits



Part Number	Diameter	Drilling Depth	Total Length
725059	3/8"	5"	10"
729000	3/8"	8"	13"
729001	3/8"	11"	16"
729003	7/16"	8"	13"
725060	1/2"	5"	10"
725061	1/2"	8"	13"
725062	1/2"	11"	16"
725063	1/2"	17"	22"
728946	1/2"	24"	29"
728947	1/2"	31"	36"
725064	9/16"	5"	10"
729005	9/16"	8"	13"
729006	9/16"	11"	16"
729007	9/16"	17"	22"
729008	9/16"	24"	29"
725066	5/8"	5"	10"
729010	5/8"	8"	13"
725067	5/8"	11"	16"
725068	5/8"	17"	22"
728948	5/8"	24"	29"
728949	5/8"	31"	36"
729012	11/16"	8"	13"
729013	11/16"	11"	16"
725069	3/4"	5"	10"
729015	3/4"	8"	13"
725070	3/4"	11"	16"
725071	3/4"	17"	22"
729016	3/4"	24"	29"
729017	3/4"	31"	36"
729019	7/8"	8"	13"
725072	7/8"	11"	16"
725073	7/8"	17"	22"
729020	7/8"	31"	36"
729022	1"	8"	13"
725074	1"	11"	16"
725075	1"	17"	22"

## SPLINE DRILL BITS

### 2-Cutter Drill Bits (cont.)

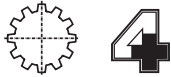

Part Number	Diameter	Drilling Depth	Total Length
729023	1"	24"	29"
729024	1"	31"	36"
725076	1-1/8"	11"	16"
725077	1-1/8"	17"	22"
725078	1-1/4"	11"	16"
725079	1-1/4"	17"	22"
729026	1-1/4"	24"	29"
725080	1-3/8"	11"	16"
725081	1-3/8"	17"	22"
985376	1-1/2"	11"	16"
725082	1-1/2"	17"	22"
728959	1-5/8"	17"	22"
729028	1-3/4"	17"	22"
729029	2"	17"	22"

## SPLINE DRILL BITS

### 4-Cutter Drill Bits



P/N 725090

Part Number	Diameter	Drilling Depth	Total Length
725086	5/8"	5"	10"
725087	5/8"	11"	16"
728950	5/8"	17"	22"
725088	5/8"	24"	29"
728951	5/8"	31"	36"
728952	11/16"	11"	16"
725089	3/4"	5"	10"
725090	3/4"	11"	16"
725091	3/4"	17"	22"
725092	3/4"	24"	29"
728953	3/4"	31"	36"
725093	7/8"	11"	16"
725094	7/8"	17"	22"
728954	7/8"	31"	36"
725095	1"	11"	16"
725096	1"	17"	22"
725097	1"	24"	29"
728955	1"	31"	36"
725098	1-1/8"	11"	16"
725099	1-1/8"	17"	22"
725100	1-1/4"	11"	16"
725101	1-1/4"	17"	22"
725102	1-1/4"	24"	29"
728957	1-1/4"	31"	36"
725103	1-3/8"	11"	16"
725104	1-3/8"	17"	22"
725105	1-1/2"	17"	22"
728959	1-5/8"	17"	22"
725084	1-3/4"	18"	23"
725085	2"	18"	23"

## Demolition Bits

For use in concrete, masonry and natural stone

### Advantages:

- Optimized cutting edge geometry for best removal rate
- High quality high carbon hardened steel for long life time
- Head hardness of 52 to 57 HRC allows the bit to achieve wear resistance up to 50 Joules
- Fully hardened material for re-sharpening and re-forging
- High homogenous steel structure gives perfect balance between wear resistance and toughness for optimal working results
- Optimized heat treatment (hardening and tempering) ensures best quality for the finished steel
- High tolerance milled shank suitable for continuous heavy duty usage and insures perfect fit with the tool
- CNC controlled manufacturing ensures 100% quality consistency

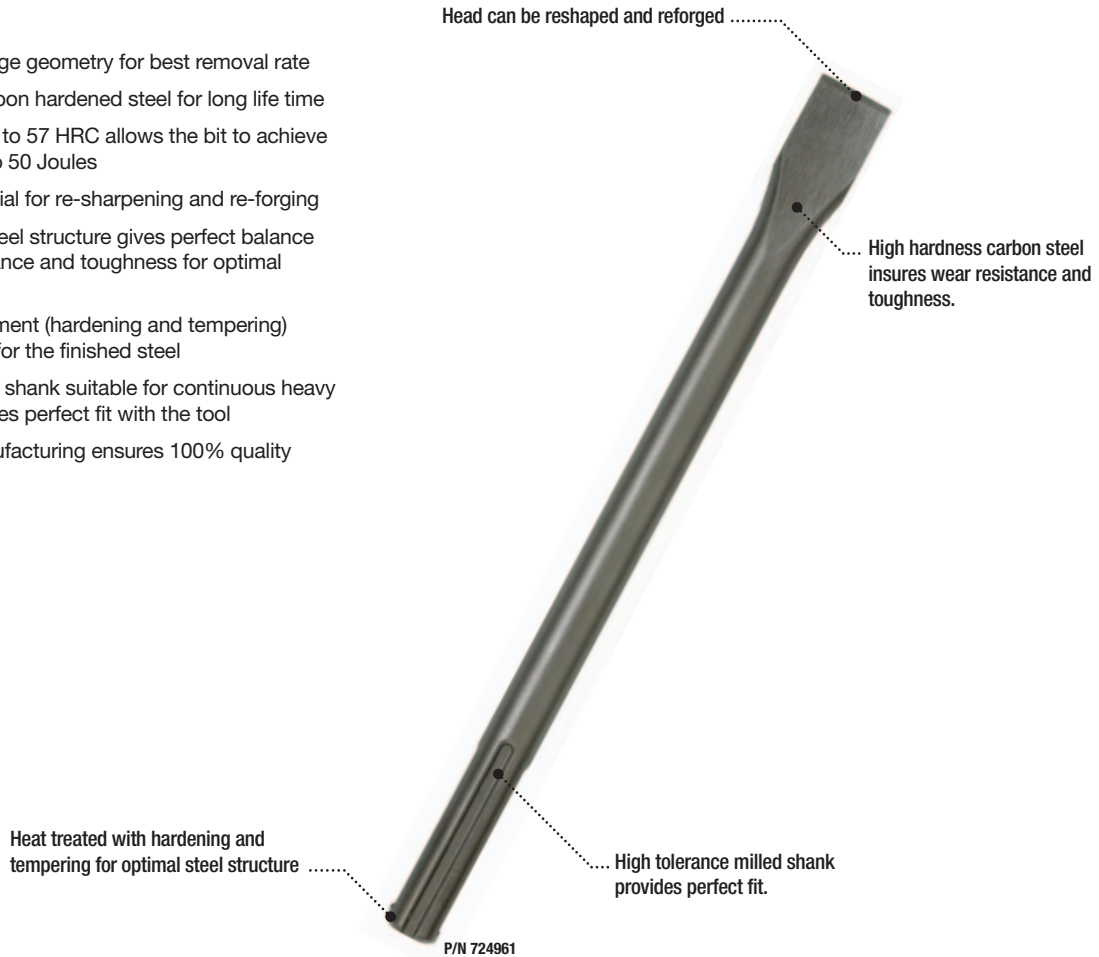

Bull Point

Flat Narrow

Flat

Flat Wide

Asphalt Cutter

Slotting Tool



## SDS-PLUS CHISELS



Part Number	Width	Total Length	Description
725198	N/A	10"	Bull Point
725199	3/4"	10"	Flat Narrow Chisel
725202	1-1/2"	10"	Flat Wide Chisel
729180	N/A	10"	Gouging Chisel
729183	N/A	10"	Tile Removing Chisel
729184	N/A	10"	Carbide Tip Bull Point
729185	N/A	3/4"	Stubby Flat Chisel
729186	N/A	N/A	Stubby Bullpoint Chisel
729187	N/A	1-1/2"	Flat Chisel
729189	N/A	10"	VPR Flat Chisel
729191	3/8"	7"	Woodworking Chisel
729192	1/2"	7"	Woodworking Chisel
729193	3/4"	7"	Woodworking Chisel
729194	1"	7"	Woodworking Chisel



Seam Tool



5/8" Ground Rod



Shank & Plate



Bushing Tool



Clay Spade



Floor Scraper



Accessories

## SDS-MAX CHISELS



R-Tec Reflection Point Technology

Part Number		Width	Total Length	Description
Each	25 Pack			
724963	724963B	N/A	12"	Bull Point
724964	724964B	N/A	18"	Bull Point
724961	724961B	1"	12"	Flat Narrow Chisel
724962	724962B	1"	18"	Flat Narrow Chisel
724965		2"	12"	Flat Chisel
724966		3"	12"	Flat Wide Chisel
728820		4-1/2"	15"	Asphalt Cutter
724967		1-1/8"	15"	Slotting Tool
724968		1"	12"	Gouge
724958		1-1/2" O.D. x 7/8" I.D.	10-1/4"	5/8" Ground Rod
728800		5" x 5" to 1" I.D.		Tamper Plate
728821		13/16" to 1" O.D.	12"	Tamper Plate Shank
724960		1-3/4" Square	9-1/4"	Bushing Tool
724969		5"	16"	Clay Spade
728822		6"	25"	Floor Scraper
728836		6"	25"	Floor Scraper-2 pc system
728854	Replacement Blade for Floor Scraper (728822)			
728831		1"	15"	Winged Channel Chisel
728833		N/A	16"	VPR Bullpoint Chisel

## SPLINE/ HEX ROUND CHISELS



Part Number		Width	Total Length	Description
Each	25 Pack			
985383	985383B	N/A	12"	Bull Point
985398	985398B	N/A	18"	Bull Point
985381	985381B	1"	12"	Flat Narrow Chisel
985382	985382B	1"	18"	Flat Narrow Chisel
985384		1-1/2"	12"	Flat Chisel
985385		2"	12"	Flat Chisel
724890	724890B	3"	12"	Flat Wide Chisel
728805		4-1/2"	15"	Asphalt Cutter
725132		1-1/8"	15"	Slotting Tool
728802		1-1/8"	15"	Seam Tool
724891		1-1/2" O.D. x 7/8" I.D.	10-1/4"	5/8" Ground Rod Driver
728800		5" x 5" to 1" I.D.		Tamper Plate
728803		13/16" to 1" O.D.	12"	Tamper Plate Shank
728801		1-3/4" Square	10"	Bushing Tool
985386		4-1/2"	17"	Clay Spade
728804		6"	25"	Floor Scraper
728854	Replacement Blade for Floor Scraper (728804)			
728815		6"	25"	Floor Scraper-2 pc system



## 3/4" HEX CHISELS



Part Number		Width	Total Length	Description
Each	25 Pack			
985430	985430B	N/A	12"	Bull Point
985431	985431B	N/A	18"	Bull Point
985432	985432B	1"	12"	Cold Chisel
985433	985433B	1"	20"	Cold Chisel
725127		2-3/8"	12"	Asphalt Cutter
985434		3"	12"	Scaling Chisel
725197		5"	16-1/2"	Asphalt Cutter
725128		1-1/2" O.D. x 7/8" I.D.	10-1/4"	5/8" Ground Rod Driver
728800		5" x 5" to 1" I.D.		Tamper Plate
728840		13/16" to 1" O.D.	12"	Long Tamper Plate Shank
725124		1-7/8" Square	9-1/4"	Bushing Tool
725125		1-7/8" Square	13/16" I.D.	Bushing Head
725126		3/4" to 13/16" O.D.	9-1/4"	Bushing Shank
725129		4-1/2"	17"	Clay Spade
728841		6"	25"	Floor Scraper
728854		Replacement Blade for Floor Scraper (728841)		
728842		6"	25"	Floor Scraper-2 pc system

## 1-1/8" HEX CHISELS



Part Number		Width	Total Length	Description
Each	25 Pack			
985230	985230B	N/A	20"	Bull Point
985231	985231B	1-3/8"	20"	Cold Chisel
985232		3"	20"	Scaling Chisel
725130		5"	17"	Asphalt Cutter
725131		1-1/8" I.D. x 2-1/8" O.D.	15"	1" Ground Rod Driver
985233		5-1/2"	20"	Clay Spade
728860		8" x 8" to 1-1/2" I.D.		Tamper plate
207001		6" x 6" to 1-1/2" I.D.		Tamper plate
207002		1-5/16" tp 1-1/2" O.D.	15"	Tamper Shank

Accessories

## Lightweight Hollow Core Bits

For use with heavy-duty hammer drills and SDS Plus Rotary Hammers in masonry, aerated concrete and natural stone.

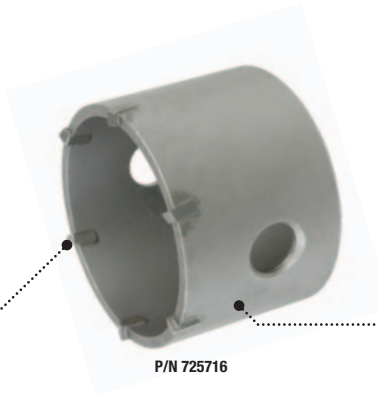

M16 Thread for easy shank or core bit exchange. Can be used with SDS Plus or Straight Shanks

Various lengths of shank adapters allow for flexible and economical use of the system

6 carbide tips provide high speed penetration

Wide range of diameters for a variety of applications

## M16 THREAD HOLLOW CORE BIT

### 1:20 Internal Tapered Shank (A-Taper)

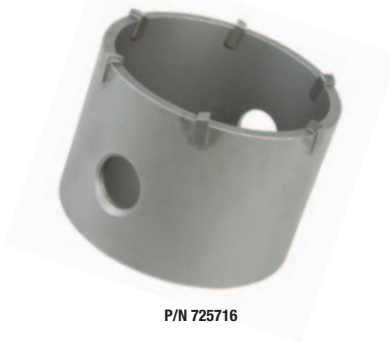

Part Number	Each	Diameter	Drilling Depth	Total Length	Number of teeth
725710		1-3/16"	2-1/4"	3-1/8"	6
725711		1-3/8"	2-1/4"	3-1/8"	6
725712		1-1/2"	2-1/4"	3-1/8"	6
725713		1-3/4"	2-1/4"	3-1/8"	6
725714		2"	2-1/4"	3-1/8"	6
725715		2-1/2"	1-7/8"	2-3/4"	6
725716		3-1/4"	1-7/8"	2-3/4"	6
725717		3-1/2"	1-7/8"	2-3/4"	6
725718		4"	1-7/8"	2-3/4"	8

## CENTERING DRILL BIT

### 1:20 Tapered Shank

For accurate spot drilling and centering of core bit



Part Number	Each	Diameter	Drilling Depth	Total Length
725700		3/8"	1-1/2"	4"

## SHANK ADAPTERS



Part Number	Each	Diameter	Drilling Depth	Total Length	Shank
725705		N/A	N/A	4" Threaded	Straight
725706		N/A	N/A	8-3/4" Threaded	Straight
725707		N/A	N/A	14-9/16" Threaded	Straight
725702		N/A	N/A	4" Threaded	SDS-Plus
725703		N/A	N/A	8-3/4" Threaded	SDS-Plus
725704		N/A	N/A	14-9/16" Threaded	SDS-Plus

## DRIFT KEY

For easy disassembly of core bit, adapter and centering drill bit

Part Number	Each	Diameter	Drilling Depth	Total Length
725701		0.3"	N/A	3"



## Heavy-Duty Hollow Core Bits

Heavy duty universal bit for use with SDS Plus, Spline and SDS Max rotary hammers.



Reinforced with industrial grade carbide teeth, core bit rim ensures rapid penetration through the hardest materials.

Multi-piece system to fit all popular shank rotary hammers

Full length external fluting prolongs bit life and minimizes friction losses.

Wide range of diameters for a variety of applications

## HEAVY-DUTY HOLLOW CORE BIT

### 1:8 Internal Tapered Shank (A-Taper)



Part Number	Each	Diameter	Drilling Depth	Total Length	Number of teeth
725751	1-3/8"	1-3/8"	2-3/8"	5	
725752	1-1/2"	3"	4"	4	
725753	1-3/4"	1-1/2"	2-3/8"	6	
725754	2"	3"	4"	6	
725755	2-1/2"	3"	4"	10	
725756	3-1/8"	3"	4"	8	
725757	3-1/2"	3"	4"	12	
725758	4"	3"	4"	12	
725759	5"	3"	4"	16	

## CENTERING DRILL BIT

For accurate spot drilling and centering of core bit



Part Number	Each	Diameter	Drilling Depth	Total Length	Shank
725730	7/16"	2-3/4"	4-3/4"	1:20 Tapered	
725731	3/8"	3-1/2"	6"	1:20 Tapered	

## SHANK ADAPTERS



Part Number	Each	Diameter	Drilling Depth	Total Length	Shank
725736	N/A	N/A	8-1/2" Tapered	Spline	
725737	N/A	N/A	17-1/4" Tapered	Spline	
725734	N/A	N/A	7" Tapered	SDS-Max	
725735	N/A	N/A	18" Tapered	SDS-Max	

## DRIFT KEY

For easy disassembly of core bit, adapter and centering drill bit



Part Number	Each	Diameter	Drilling Depth	Total Length

Accessories

## 1pc. Core Cutters

For use in concrete, masonry and natural stone.

Chisel-shaped carbide teeth insure fast bit penetration rate.

High performer when drilling through reinforced concrete. Integrated centering bit insures accurate spot drilling.

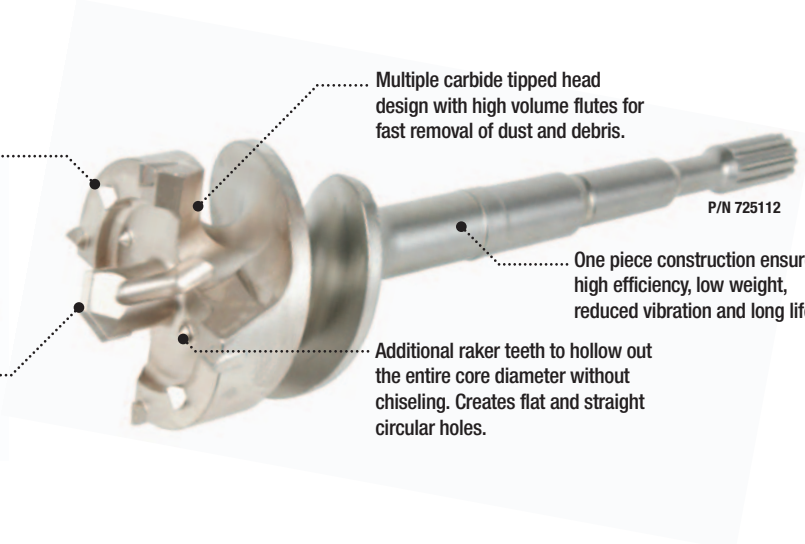
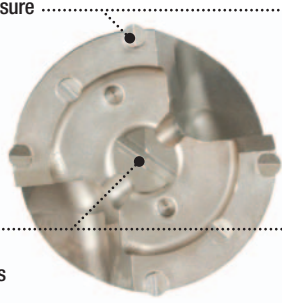

Multiple carbide tipped head design with high volume flutes for fast removal of dust and debris.

P/N 725112

One piece construction ensures high efficiency, low weight, reduced vibration and long life.

Additional raker teeth to hollow out the entire core diameter without chiseling. Creates flat and straight circular holes.

## SDS-MAX SHANK 1 PC. CORE BIT



P/N 724957

Part Number	Diameter	Total Length
724940	1-1/2"	12-1/4"
724941	1-1/2"	22"
724942	1-3/4"	12-1/4"
724954	1-3/4"	22"
724944	2-1/8"	12-1/4"
724955	2-1/8"	22"
724946	2-1/2"	12-1/4"
724956	2-1/2"	22"
724957	3-1/8"	22"

## SPLINE SHANK 1 PC. CORE BIT



P/N 725112

Part Number	Diameter	Total Length
725106	1-1/2"	12-1/4"
725107	1-1/2"	22"
724950	1-3/4"	12-1/4"
724951	1-3/4"	22"
725108	2-1/8"	12-1/4"
725109	2-1/8"	22"
725110	2-1/2"	12-1/4"
725111	2-1/2"	22"
725112	3-1/8"	12-1/4"
725113	3-1/8"	22"

## 1 pc. Hollow Core Bits

1 Piece Hollow Core Bits with integrated SDS-Max or Spline shanks. Specially suited for modern, powerful rotary hammers.

A performance increase exceeding 30% is achieved with this new design. The high hammer power of modern, heavy rotary hammer drills can be fully exploited.

Hollow crown body with a more efficient outer spiral for increased durability and minimized friction.

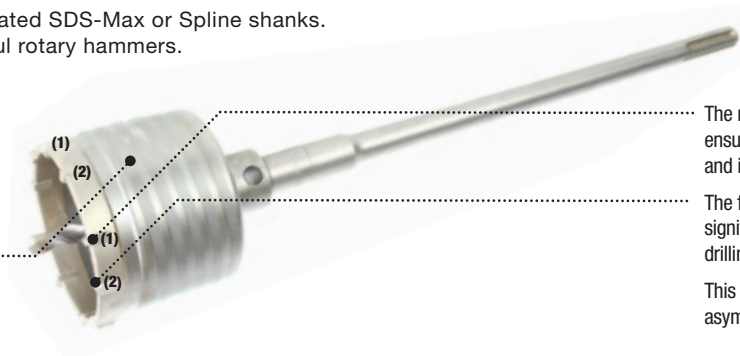
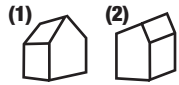

The roof-shaped guide teeth **(1)** ensure improved tool alignment and increased rotational stability.

The flat hammer teeth **(2)** are significantly more efficient in this drilling base.

This effect is supported by the asymmetrical tooth layout.

## SDS-MAX SHANK 1 PC. HOLLOW CORE BIT



P/N 724933

Part Number	Diameter	Total Length
724920	1-1/2"	11-3/8"
724921	1-1/2"	22"
724922	1-3/4"	11-3/8"
724923	1-3/4"	22"
724943	1-3/4"	39"
724924	2"	11-3/8"
724925	2"	22"
724945	2-1/8"	39"
724947	2-1/2"	39"
724926	2-5/8"	11-3/8"
724927	2-5/8"	22"
724928	3-1/8"	11-3/8"
724948	3-1/8"	12-1/4"
724929	3-1/8"	22"
724930	3-1/2"	11-3/8"
724931	3-1/2"	22"
724932	4"	11-3/8"
724933	4"	22"
724934	5"	11-3/8"
724935	5"	22"
724937	6"	22"



Accessories

## SPLINE SHANK 1 PC. HOLLOW CORE BIT



P/N 725772

Part Number	Diameter	Total Length
725760	1-1/2"	12"
725761	1-1/2"	22"
725762	1-3/4"	11-3/8"
725763	1-3/4"	22"
725764	2"	11-3/8"
725765	2"	22"
725766	2-5/8"	11-3/8"
725767	2-5/8"	22"
725768	3-1/8"	11-3/8"
725769	3-1/8"	22"
725770	3-1/2"	11-3/8"
725771	3-1/2"	22"
725772	4"	11-3/8"
725773	4"	22"
725774	5"	11-3/8"
725775	5"	22"
725777	6"	22"

## CENTERING BIT

### 1:20 Tapered Shank (A-Taper)

For accurate spot drilling and centering of core bit



Part Number	Diameter	Total Length	Shank
725730	7/16"	4-3/4"	1:20 Taper Shank (A-Taper)

## DRIFT KEY

For easy disassembly of core bit centering drill bit



Part Number	Diameter	Total Length	Shank
724939	3/8"	N/A	N/A



## 3 pc. Core Cutter Bits with Internal Thread

3 Piece Core Cutter Bit with internal thread and 4" drilling depth x 5-3/4" total length. Heavy duty core bit system for use with Spline and SDS-Max rotary hammers. For use in reinforced and non-reinforced concrete, natural stone, brick, block and other masonry.

Center pin provides accurate centering.

Special tooth geometry for easy penetration through reinforced concrete.

External core spiral flute reduces friction.

Industrial grade carbide teeth prolong life of the bit.

Diameter up to 6" with drilling depth 4" for most common applications.

Modular system for application flexibility.

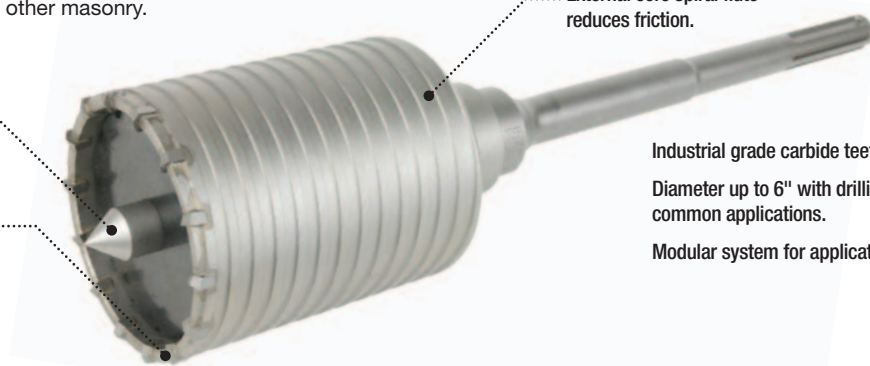

## 3 PC. HOLLOW CORE BIT



Core Bit Part Numbers			Diameter	Shank Part Numbers	
Core Bit	Core Bit Guide Plate	Center Pin		SDS Max - 12"	Spline - 9"
955994*		318530	1"	313466	984029
955995*		318530	1-1/8"	313466	984029
955996	955997	956009	1-1/4"	313466	984029
955998	955999	956009	1-3/8"	313466	984029
956000	956001	955165	1-1/2"	313467	985379
955154	955166	955165	1-3/4"	313467	985379
985380	985388	955165	2"	313467	985379
955155	955167	955165	2-1/8"	313467	985379
956002	956003	955165	2-1/2"	313467	985379
955157	955168	955165	3-1/8"	313467	985379
987011*		955165	3-1/2"	313467	985379
956004	956005	955165	3-11/16"	313467	985379
955159	955169	955165	4-1/8"	313467	985379
956006	956007	955165	4-3/4"	313467	985379
987013*		955165	5"	313467	985379
956728	956743	955165	6"	313467	985379

\* Includes Guide Plate

## Power Reach Extension System

For drilling 1-3/16" or larger holes in concrete, masonry and natural stone.

The two SDS-Max chucks provide a quick and safe connection between the drilling tool and the extension shanks.

There is no energy loss normally encountered in traditional adapter systems.

There are no weak points making breakages through excessive strain difficult.

Suitable with SDS-Plus, Spline and SDS-Max rotary hammers.

Use with SDS-Max rotary hammer bits that are 1-3/16" and larger.

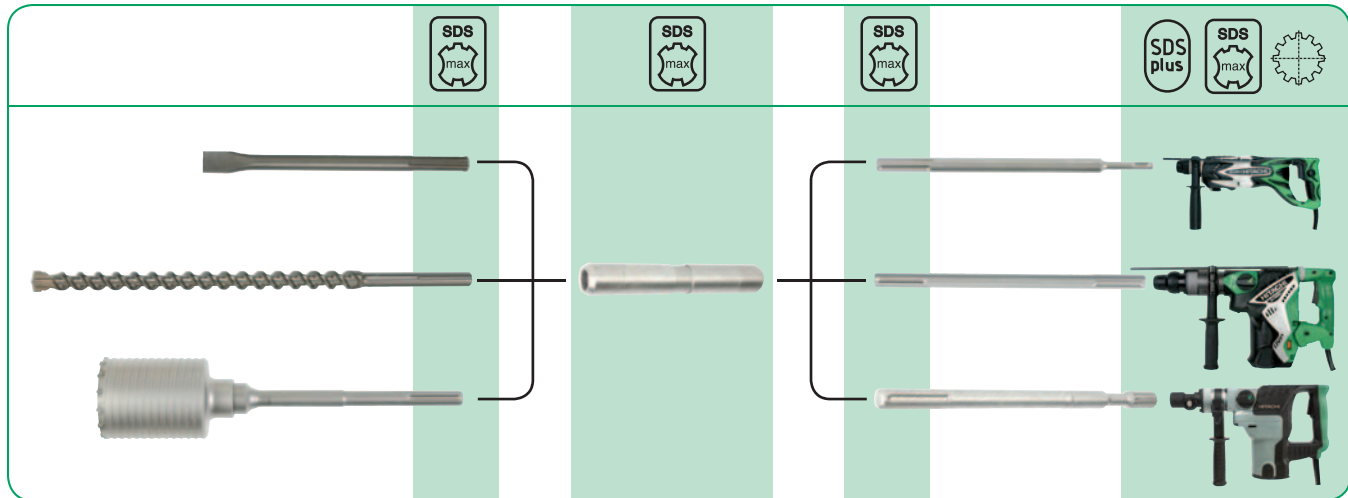

## SDS-MAX QUICK CHANGE SHANK TO SHANK ADAPTER

Part Number	Description	Diameter	Total Length
Each			
725780	SDS Max Quick Change Shank to Shank Adapter	1-3/16"	7-1/2"



## ADAPTER SHANKS



Part Number	Description	Shank	Total Length
Each			
725782	Adapter Shank	SDS-Max	12-1/2"
725785	Adapter Shank	SDS-Plus	12-1/2"
725787	Adapter Shank	Spline	12-1/2"
725783	Adapter Shank	SDS-Max	29-1/2"
725786	Adapter Shank	SDS-Plus	29-1/2"
725788	Adapter Shank	Spline	29-1/2"
725784	Adapter Shank	SDS-Max	43"



## ADAPTER GREASE

Part Number	Description
Each	
725781	Special Adapter Grease, 10g Tube



## Shank Adapters



Accessories

### SDS-PLUS SHANK ADAPTERS



Part Number	Each	From	To
302978		SDS-Plus	W 5/16 Round Anchor Setting
303044		SDS-Plus	1/2" Square Male Drive (Impact Sockets)
303332		SDS-Plus	1/2" 3-Jaw Chuck (Hammer Drilling)
303820		SDS-Plus	1/2" 3-Jaw Chuck (Drilling Only)
725703		SDS-Plus	Lightweight Core Bit, 8-3/4" Threaded
725704		SDS-Plus	Lightweight Core Bit, 14-9/16" Threaded
725733		SDS-Plus	Hollow Core Bit
725792		SDS-Plus	1/2" 20-Thread
725795		SDS-Plus	1/4" Hex Female Drive (Screw Driving)

### SPLINE SHANK ADAPTERS



Part Number	Each	From	To
725736		Spline	Hollow Core Bit for 8-1/2" Tapered
725737		Spline	Hollow Core Bit for 17-1/4" Tapered
984029		Spline	3-Piece Core Bit for 1-3/8" or greater
985379		Spline	3-Piece Core Bit for 1-1/2" or less
725791		Spline	SDS-Plus
985377		Spline	Taper Shank Adapter (A)
985378		Spline	Taper Shank Adapter (B)
725793		Spline	SDS-Max
725797		Spline	1/2" 20-Thread

### SDS-MAX SHANK ADAPTERS



Part Number	Each	From	To
725734		SDS-Max	Hollow Core Bit, 7" Tapered
725735		SDS-Max	Hollow Core Bit, 18" Tapered
313466		SDS-Max	3-Piece Core Bit for 1-3/8" or greater
313467		SDS-Max	3-Piece Core Bit for 1-1/2" or less
725790		SDS-Max	SDS-Plus
725794		SDS-Max	Spline
725798		SDS-Max	1/2" 20-Thread

## Grinding/Cutting Wheel Information Guide

### Multi-Layer Construction

**Top Layer of Glass Fiber** ..... protects the worker against chipping off of abrasive grains.

**Fine Grit Layer on Top** ..... for better connection with glass fiber reinforcement, increases safety and acts like a backup for the coarse grit.

**Coarse Grit Layer on Bottom** ..... improves stock removal rate and keeps grinding much longer because the fine grit backup allows greater force against the coarse grit.

**Bottom Layer of Glass Fiber** ..... half as thick as most competitors, allowing for better start up because the grains act right from the beginning (fiber glass does not grind).

**Coarse and Fine Grit Combination** ..... allows to influence the surface finish on the work piece by altering the grinding angle or movement in direction to or away from the worker.

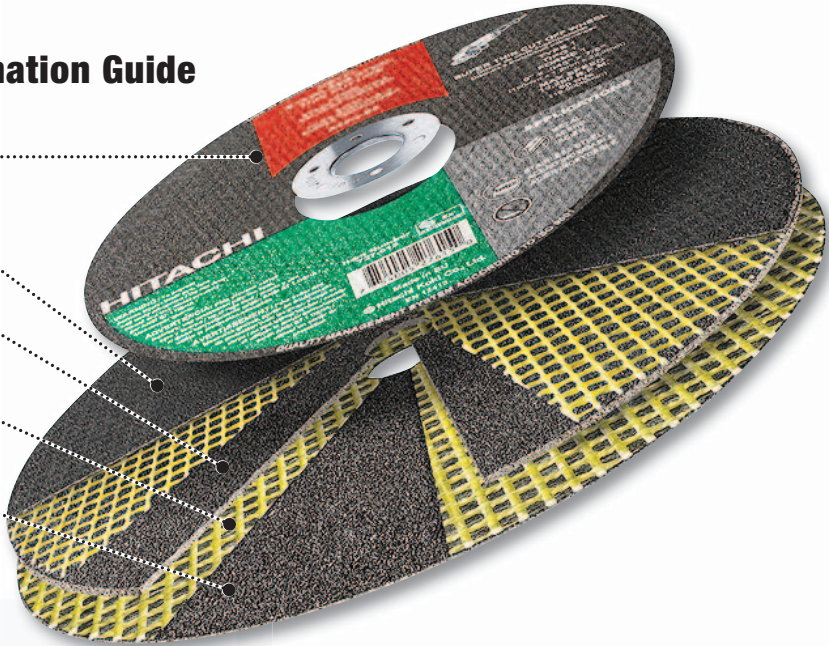

## Industry Color-Coded System

- METAL / GENERAL PURPOSE
- CONCRETE / MASONRY
- STAINLESS
- PIPELINE
- ASPHALT
- ALUMINUM

## ANSI Standard Marking System

For identifying grinding wheels and other bonded abrasives. Sample: A 60 Q-BF

A	60	Q	BF																																									
<b>Material</b>	<b>Grit Size</b>	<b>Hardness of Bond</b>	<b>Type of Bond</b>																																									
A = Aluminum C = Silicon Carbide Z = Aluminum Zirconium SG = Seeded Gel	<table border="1" style="font-size: small;"> <tr> <td>Coarse</td> <td>Medium</td> <td>Fine</td> <td>Very Fine</td> </tr> <tr> <td>8</td> <td>30</td> <td>70</td> <td>220</td> </tr> <tr> <td>10</td> <td>36</td> <td>80</td> <td>240</td> </tr> <tr> <td>12</td> <td>46</td> <td>90</td> <td>280</td> </tr> <tr> <td>14</td> <td>54</td> <td>100</td> <td>320</td> </tr> <tr> <td>16</td> <td>60</td> <td>120</td> <td>400</td> </tr> <tr> <td>20</td> <td>-</td> <td>150</td> <td>500</td> </tr> <tr> <td>24</td> <td>-</td> <td>180</td> <td>600</td> </tr> </table>	Coarse	Medium	Fine	Very Fine	8	30	70	220	10	36	80	240	12	46	90	280	14	54	100	320	16	60	120	400	20	-	150	500	24	-	180	600	<table border="1" style="font-size: small;"> <tr> <td>Soft</td> <td>Medium</td> <td>Hard</td> </tr> <tr> <td>A</td> <td>Q</td> <td>R</td> </tr> <tr> <td></td> <td>S</td> <td>Z</td> </tr> </table>	Soft	Medium	Hard	A	Q	R		S	Z	B = Resinoid BF = Resinoid Reinforced E = Shellac O = Oxychloride R = Rubber RF = Rubber Reinforced S = Silicate V = Vitrified
Coarse	Medium	Fine	Very Fine																																									
8	30	70	220																																									
10	36	80	240																																									
12	46	90	280																																									
14	54	100	320																																									
16	60	120	400																																									
20	-	150	500																																									
24	-	180	600																																									
Soft	Medium	Hard																																										
A	Q	R																																										
	S	Z																																										

## Wheel Configuration and Applications

Select from a variety of bonded abrasive wheel configurations depending on type of tool being used, application and desired results.

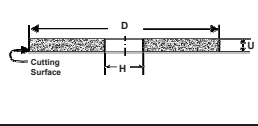
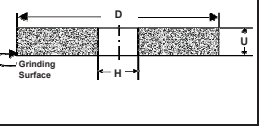
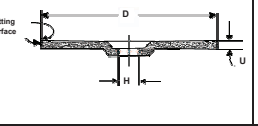
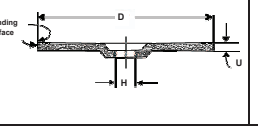
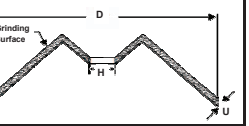
Type 1A (ISO 41) CUTTING	Type 1 GRINDING	Type 27A CUTTING	Type 27 BLENDING GRINDING	Type 29 BLENDING GRINDING
				
<b>Straight Wheel</b>	<b>Straight Wheel</b>	<b>Depressed Center Wheel</b>	<b>Depressed Center Wheel</b>	<b>Flexible Wheel / Flap Disc</b>
<b>Type 1A (ISO 41)</b> Used at a 90° angle for cutting only. No grinding.	<b>Bench or Type 1</b> Used for edge grinding at a 50°-90° angle. Not for cutting applications.	<b>Type 27A</b> To be used at a 90° angle for light cut-off work.	<b>Type 27</b> For use on flat surfaces for weld prep, usually on bar stock or angle iron. Tool best used at a 10°-15° angle. No cutting.	<b>Type 29</b> For blending and stock removal on uneven surfaces, best used at a 10° angle. This allows user to use one wheel to grind and finish with.

## Grinding Wheel Selection Guide

### 1. ABRASIVE GRAINS

Abrasive grains are particles of man-made abrasive compounds. While some manufacturers use recycled grains, Hitachi abrasives use only high quality, virgin grains that are made to our specifications. The chemical structure of the grains determine the physical properties of the grains (i.e., shape, sharpness, hardness, friability). Common grain types used in making bonded abrasives include:

- A - Aluminum Oxide** A coarse, blocky shaped grain best used for cutting and grinding metals, including ferrous metals without excessive fracturing.
- C - Silicon Carbide** A very hard and sharp abrasive suited for non-metallic materials such as concrete.
- Z - Aluminum Zirconium** A very fine, dense crystalline grain which, because of its durability, can be used for very rapid and aggressive stock removal.
- SG - Seeded Gel** High performance wheel made by a carefully controlled manufacturing process using aluminum oxide grains. Seeded gel abrasive wheels stay sharp the longest, and require the least maintenance.

### 2. BONDING AGENT

The bonding agent that holds the grains together determines the resistance of the wheel. Hitachi abrasives use a resinoid bond that is formulated to meet unique specifications of each product.

### 3. REINFORCEMENT

The reinforcement material provides extra strength to use the wheel at maximum RPMs and withstand lateral pressure that is applied during use. Hitachi uses multiple layers of long, stranded fiberglass that are woven to form an exceptionally strong reinforcement layer specific to the application.

### COMBINING THE 3 COMPONENTS

During the manufacturing process, these three components are combined to form a grinding wheel. The grains and bonding agents are measured, combined and pressed in an automated hydraulic press. Hitachi abrasives labels are also incorporated into the manufacturing process and therefore remain intact throughout the life of the wheel.

Accessories

## METAL GRINDING



P/N: 727535B10



P/N: 727714B5

### Depressed Wheels and Flap Discs for Metal

Part Number	Diameter	Shape	Hub	Application	Type	Grit	Thickness	Arbor	Qty
727506B10	4"	Depressed	N/A	Steel/Inox Grinding/Blending	27	A24P-BF	1/4"	5/8"	10
727700B10	4"	Flap	N/A	Steel/Inox Grinding/Blending	29, Flap Disc	ZA40-B	NA	5/8"	10
727701B10	4"	Flap	N/A	Steel/Inox Grinding/Blending	29, Flap Disc	ZA60-B	NA	5/8"	10
727702B10	4"	Flap	N/A	Steel/Inox Grinding/Blending	29, Flap Disc	ZA80-B	NA	5/8"	10
727535B10	4-1/2"	Depressed	N/A	Steel/Inox Grinding	27	A24P-BF	1/4"	7/8"	10
727536B10	4-1/2"	Depressed	With Hub	Steel/Inox Grinding	27	A24P-BF	1/4"	5/8"-11	10
727710B10	4-1/2"	Flap	N/A	Steel/Inox Grinding/Blending	29, Flap Disc	ZA40-B	NA	7/8"	10
727711B10	4-1/2"	Flap	N/A	Steel/Inox Grinding/Blending	29, Flap Disc	ZA60-B	NA	7/8"	10
727712B10	4-1/2"	Flap	N/A	Steel/Inox Grinding/Blending	29, Flap Disc	ZA80-B	NA	7/8"	10
727713B10	4-1/2"	Flap	N/A	Steel/Inox Grinding/Blending	29, Flap Disc	ZA120-B	NA	7/8"	10
727714B5	4-1/2"	Flap	With Hub	Steel/Inox Grinding/Blending	29, Flap Disc	ZA40-B	NA	5/8"-11	5
727715B5	4-1/2"	Flap	With Hub	Steel/Inox Grinding/Blending	29, Flap Disc	ZA60-B	NA	5/8"-11	5
727716B5	4-1/2"	Flap	With Hub	Steel/Inox Grinding/Blending	29, Flap Disc	ZA80-B	NA	5/8"-11	5
727565B10	5"	Depressed	N/A	Steel/Inox Grinding	27	A24P-BF	1/4"	7/8"	10
727566B10	5"	Depressed	With Hub	Steel/Inox Grinding	27	A24P-BF	1/4"	5/8"-11	10
727720B10	5"	Flap	N/A	Steel/Inox Grinding/Blending	29, Flap Disc	ZA40-B	NA	7/8"	10
727721B10	5"	Flap	N/A	Steel/Inox Grinding/Blending	29, Flap Disc	ZA60-B	NA	7/8"	10
727722B10	5"	Flap	N/A	Steel/Inox Grinding/Blending	29, Flap Disc	ZA80-B	NA	7/8"	10
727585B10	7"	Depressed	N/A	Steel/Inox Grinding	27	A24P-BF	1/4"	7/8"	10
727586B10	7"	Depressed	With Hub	Steel/Inox Grinding	27	A24P-BF	1/4"	5/8"-11	10
727587B10	7"	Depressed	With Hub	High Performance Steel/Inox Grinding	27	ZA24P-BF	1/4"	5/8"-11	10
727730B10	7"	Flap	N/A	Steel/Inox Grinding/Blending	29, Flap Disc	ZA40-B	NA	7/8"	10
727731B10	7"	Flap	N/A	Steel/Inox Grinding/Blending	29, Flap Disc	ZA60-B	NA	7/8"	10
727732B10	7"	Flap	N/A	Steel/Inox Grinding/Blending	29, Flap Disc	ZA80-B	NA	7/8"	10
727733B10	7"	Flap	N/A	Steel/Inox Grinding/Blending	29, Flap Disc	ZA120-B	NA	7/8"	10
727734B5	7"	Flap	With Hub	Steel/Inox Grinding/Blending	29, Flap Disc	ZA40-B	NA	5/8"-11	5
727735B5	7"	Flap	With Hub	Steel/Inox Grinding/Blending	29, Flap Disc	ZA60-B	NA	5/8"-11	5
727736B5	7"	Flap	With Hub	Steel/Inox Grinding/Blending	29, Flap Disc	ZA80-B	NA	5/8"-11	5
727625B10	9"	Depressed	N/A	Steel/Inox Grinding/Blending	27	A24P-BF	1/4"	7/8"	10
727630B10	9"	Depressed	With Hub	Steel/Inox Grinding/Blending	27	A24P-BF	1/4"	5/8"-11	10

## METAL CUTTING



P/N: 727550B25



P/N: 727541B25

### Depressed and Flat Cutting Wheels for Metal

Part Number	Diameter	Shape	Hub	Application	Type	Grit	Thickness	Arbor	Qty
727520B25	4"	Flat	N	Steel/Inox/Stainless Steel Thin Cutting	1	A60T-BF	0.040"	5/8"	25
727521B25	4"	Flat	N	Steel/Inox/Stainless Steel Thin Cutting	1	A46T-BF	0.060"	5/8"	25
727505B10	4"	Depressed	N	Steel/Inox/Stainless Steel Cutting	27	A30P-BF	1/8"	5/8"	25
727550B25	4-1/2"	Flat	N	Steel/Inox/Stainless Steel Thin Cutting	1	A60Q-BF	0.040"	7/8"	10
727551B25	4-1/2"	Flat	N	Steel/Inox/Stainless Steel Thin Cutting	1	A46Q-BF	0.060"	7/8"	25
727540B25	4-1/2"	Depressed	N	Steel/Inox/Stainless Steel Thin Cutting	27	A60Q-BF	0.040"	7/8"	25
727530B10	4-1/2"	Depressed	N	Steel/Inox/Stainless Steel Cutting	27	A30P-BF	1/8"	7/8"	10
727531B10	4-1/2"	Depressed	Y	Steel/Inox/Stainless Steel Cutting	27	A30P-BF	1/8"	5/8"-11	10
727541B25	4-1/2"	Depressed	N	Steel/Inox/Stainless Steel Ultra Thin Cutting	27	A60R-BF	0.030"	7/8"	25
727570B25	5"	Flat	N	Steel/Inox/Stainless Steel Thin Cutting	1	A60Q-BF	0.040"	7/8"	25
727571B25	5"	Flat	N	Steel/Inox/Stainless Steel Thin Cutting	1	A46Q-BF	0.060"	7/8"	25
727561B25	5"	Depressed	N	Steel/Inox/Stainless Steel Thin Cutting	27	A60Q-BF	0.040"	7/8"	25
727560B10	5"	Depressed	N	Steel/Inox/Stainless Steel Cutting	27	A30P-BF	1/8"	7/8"	10
727562B25	5"	Depressed	N	Steel/Inox/Stainless Steel Ultra Thin Cutting	27	A60R-BF	0.030"	7/8"	25
727615B25	6"	Flat	N	Steel/Inox/Stainless Steel Thin Cutting	1	A60Q-BF	0.045"	7/8"	25
727616B25	6"	Flat	N	Steel/Inox/Stainless Steel Thin Cutting	1	A46Q-BF	0.060"	7/8"	25
727600B25	7"	Flat	N	Steel/Inox/Stainless Steel Thin Cutting	1	A46Q-BF	0.060"	7/8"	25
727590B25	7"	Depressed	N	Steel/Inox/Stainless Steel Thin Cutting	27	A30R-BF	0.060"	7/8"	25
727580B10	7"	Depressed	N	Steel/Inox/Stainless Steel Cutting	27	A30P-BF	1/8"	7/8"	10
727581B10	7"	Depressed	Y	Steel/Inox/Stainless Steel Cutting	27	A30P-BF	1/8"	5/8"-11	10
727620B10	9"	Depressed	N	Steel/Inox/Stainless Steel Cutting	27	A30P-BF	1/8"	7/8"	10
727621B10	9"	Depressed	Y	Steel/Inox/Stainless Steel Cutting	27	A30P-BF	1/8"	5/8"-11	10
727660B10	10"	Flat	N	Steel/Inox Cutting	1	A30P-BF	1/8"	5/8"	10
727665B10	12"	Flat	N	Steel/Inox Cutting	1	A30P-BF	1/8"	1"	10
727666B10	12"	Flat	N	Steel/Inox Cutting	1	A30P-BF	1/8"	20mm	10
727670B10	12"	Flat	N	Steel/Inox Cutting	1	A30P-BF	7/64"	1"	10
727671B10	12"	Flat	N	High Performance steel/Inox Fast Cutting	1	A36Q-BF	3/32"	1"	10
727680B10	14"	Flat	N	Steel/Inox Cutting	1	A30P-BF	1/8"	1"	10
727685B10	14"	Flat	N	Steel/Inox Cutting	1	A30P-BF	7/64"	1"	10
727686B10	14"	Flat	N	Steel/Inox Bar Cutting	1	A30P-BF	1/8"	1"	10
727687B10	14"	Flat	N	Steel/Inox Stud Cutting	1	A36P-BF	3/32"	1"	10
727688B10	14"	Flat	N	High Performance Steel/Inox Light Gauge Stud Fast Cutting	1	A36Q-BF	3/32"	1"	10

Accessories

## MASONRY GRINDING & CUTTING



P/N: 727610B25



P/N: 728730

### Depressed Wheels and Flap Discs for Masonry

Part Number	Diameter	Shape	Hub	Application	Type	Grit	Thickness	Arbor	Qty
727511B10	4"	Depressed	N	Concrete/Masonry Grinding	27	C24P-BF	1/4"	5/8"	10
727538B10	4-1/2"	Depressed	N	Concrete/Masonry Grinding	27	C24P-BF	1/4"	7/8"	10
727568B10	5"	Depressed	N	Concrete/Masonry Grinding	27	C24P-BF	1/4"	7/8"	10
727605B10	7"	Depressed	Y	Concrete/Masonry Grinding	27	C24P-BF	1/4"	5/8"-11	10
727635B10	9"	Depressed	Y	Concrete/Masonry Grinding	27	C24P-BF	1/4"	5/8"-11	10

### Depressed and Flat Cutting Wheels for Masonry

Part Number	Diameter	Shape	Hub	Application	Type	Grit	Thickness	Arbor	Qty
727525B25	4"	Flat	N	Concrete/Masonry + Non-ferrous Material Thin Cutting	1	C46S-BF	0.045"	5/8"	25
727510B25	4"	Depressed	N	Concrete/Masonry + Non-ferrous Material Cutting	27	C30P-BF	3/32"	5/8"	25
727555B25	4-1/2"	Flat	N	Concrete/Masonry + Non-ferrous Material Thin Cutting	1	C46S-BF	0.045"	7/8"	25
727537B25	4-1/2"	Depressed	N	Concrete/Masonry + Non-ferrous Material Cutting	27	C30P-BF	1/8"	7/8"	25
727575B25	5"	Flat	N	Concrete/Masonry + Non-ferrous Material Cutting	1	C46S-BF	0.045"	7/8"	25
727567B25	5"	Depressed	N	Concrete/Masonry + Non-ferrous Material Cutting	27	C30P-BF	3/32"	7/8"	25
727619B25	6"	Flat	N	Concrete/Masonry Cutting + Non-ferrous Material	1	C30P-BF	3/32"	7/8"	25
727610B25	7"	Flat	N	Concrete/Masonry + Non-ferrous Material Thin Cutting	1	C46S-BF	0.060"	7/8"	25
727661B10	10"	Flat	N	Concrete/Masonry Cutting	1	C30P-BF	1/8"	5/8"	10
727675B10	12"	Flat	N	Concrete/Masonry Cutting	1	C30P-BF	1/8"	1"	10
727676B10	12"	Flat	N	Concrete/Masonry Cutting	1	C30P-BF	1/8"	20mm	10
727679B10	12"	Flat	N	Concrete/Masonry Cutting	1	C30P-BF	1/8"	1"	10
727681B10	14"	Flat	N	Concrete/Masonry Cutting	1	C30P-BF	1/8"	1"	10
727689B10	14"	Flat	N	Concrete/Masonry Cutting	1	C30P-BF	1/8"	1"	10

## CONTINUOUS RIM BLADES



P/N: 728726

Part Number	Dia.	Description	Arbor	Rim Height	Qty
728726	4"	Pro Grade Continuous Rim Blade	7/8" + 5/8" + 20mm	5 MM	1
728737	4.5"	Premium Continuous Rim Blade	5/8"	5 MM	1
728746	7"	Pro Grade Continuous Rim Blade	5/8"	5 MM	1
728747	7"	Premium Continuous Rim Blade	5/8"	5 MM	1
728766	10"	Pro Grade Continuous Rim Blade	5/8"	5 MM	1
728767	10"	Premium Continuous Rim Blade	5/8"	5 MM	1

## TURBO RIM BLADES



P/N: 728730

P/N: 728707



Part Number	Dia.	Description	Arbor	Rim Height	Qty
728725	4"	Premium Thin Kerf Turbo Blade	7/8" + 5/8" + 20mm	5MM	1
728722	4"	Premium Protected Turbo Blade	7/8" + 5/8" + 20mm	8MM	1
729710	4.5"	Diamond Turbo Blade	7/8" + 5/8"	7 MM	1
728730	4.5"	Pro Grade Turbo Blade	7/8" + 5/8"	8 MM	1
728735	4.5"	Premium Thin Kerf Turbo Blade	7/8" + 5/8" + 20mm	5 MM	1
728732	4.5"	Premium Turbo Blade	7/8" + 5/8"	8 MM	1
728706	4.5"	Premium Protected Turbo Blade	7/8" + 5/8" + 20mm	8 MM	1
728710	5"	Pro Grade Turbo Blade	7/8" + 5/8" + 20mm	8 MM	1
728740	7"	Pro Grade Turbo Blade	5/8" w/ $\diamond$ knock out	8 MM	1
728742	7"	Premium Turbo Blade	5/8" w/ $\diamond$ knock out	8 MM	1
728745	7"	Premium Thin Kerf Turbo Blade	7/8" + 5/8" + 20mm	5 MM	1
728707	7"	Premium Protected Turbo Blade	7/8" + 5/8" + 20mm	8 MM	1
728762	10"	Premium Turbo Blade	1"	8 MM	1

## SEGMENTED RIM BLADES



P/N: 728733

P/N: 728709



Part Number	Dia.	Description	Arbor	Rim Height	Qty
728724	4"	Protected Segmented Blade	7/8" + 5/8" + 20mm	8 MM	1
728721	4"	Premium Grade Segmented Blade	7/8" + 5/8" + 20mm	11 MM	1
728733	4.5"	Pro Grade Segmented Blade	7/8" + 5/8" + 20mm	8 MM	1
728734	4.5"	Premium Segmented Blade	7/8" + 5/8" + 20mm	8 MM	1
728708	4.5"	Premium Protected Segmented Blade	7/8" + 5/8" + 20mm	8 MM	1
728731	4.5"	Premium Grade Segmented Blade	7/8" + 5/8" + 20mm	11 MM	1
728713	5"	Pro Grade Segmented Blade	7/8" + 5/8" + 20mm	8 MM	1
729742	7"	Diamond Segmented Blade	7/8" + 5/8"	10 MM	1
728743	7"	Pro Grade Segmented Blade	5/8" w/ $\diamond$ knock out	8 MM	1
728744	7"	Premium Segmented Blade	5/8" w/ $\diamond$ knock out	8 MM	1
728709	7"	Premium Protected Segmented Blade	7/8" + 5/8" + 20mm	8 MM	1
728741	7"	Premium Grade Segmented Blade	7/8" + 5/8" + 20mm	11 MM	1
728773	12"	Pro Grade Segmented Blade	1" + 20mm	8 MM	1
728783	14"	Pro Grade Segmented Blade	1" + 20mm	8 MM	1

## DIAMOND CUP WHEELS



P/N: 728712

Part Number	Dia.	Description	Arbor	Rim Height	Qty
728755	4"	Premium Turbo Cup Wheel	5/8" - 11	4.5 MM	1
728711	4.5"	Premium Turbo Cup Wheel	5/8" - 11	4.5 MM	1
728712	7"	Premium Turbo Cup Wheel	5/8" - 11	4.5 MM	1
728729	4"	Double Row Cup Wheel	5/8" - 11	5 MM	1
728749	7"	Double Row Cup Wheel	5/8" - 11	5 MM	1

Accessories

## Variety of Wire Types

Crimped Wire



### Crimped Wire

- For light duty removal and a finer finish on the work surface
- Uses a premium brass coated steel wire that is rust resistant
- Lasts 15-20% longer than competitive brushes

High Performance Cable Crimped Wire



### High Performance Cable Crimped Wire

- For light-medium duty removal and a fine finish on the work surface
- Unique to the industry- wire breaks down in smaller pieces for added safety to the user
- Lasts 50% longer than industry standard crimped wire

Twist Knot Wire



### Twist Knot

- For heavy duty removal and a rougher finish on the work surface
- High carbon tempered steel wire sourced from world class suppliers
- Tighter twist than competitive brands for longer life, more aggressive removal and perfect balance
- Variety of Wire Types
- Protective Guard found on wore cup brushes shields users from debris and is flexible in hard to reach applications
- Wheels and cups are equipped with a multi-thread arbor, which allows one brush to fit both 5/8 in.-11 & M14 x 2.0 or M10 x 1.25 and M10 x 1.50 for added flexibility



P/N: 729263

## WHEEL BRUSHES



P/N: 729302

Part Number	Dia.	Description	Arbor	Application	RPM	Qty
729260	4"	Stringer Bead Wheel	5/8"-11 and M14 x 2.0	Heavy Duty	20,000	1
729263	4"	Stringer Bead Wheel	M10 x 1.25 and M10 x 1.50	Heavy Duty	20,000	1
729290	6"	Stringer Bead Wheel	5/8"-11	Heavy Duty	9,000	1
729270	4"	Knotted Wheel Brush	5/8"-11 and M14 x 2.0	Heavy Duty	15,000	1
729273	4"	Knotted Wheel Brush	M10 x 1.25 and M10 x 1.51	Heavy Duty	15,000	1
729295	6"	Knotted Wheel Brush	5/8"-11	Heavy Duty	12,500	1
729302	6"	Crimped Bench Wheel Brush	1/2' thru 2"	Light Duty	6,500	1
729303	6"	Brass coated Cable Crimped Bench Wheel Brush	1/2' thru 2"	Light-Medium Duty	6,500	1
729306	8"	Crimped Bench Wheel Brush	1/2' thru 2"	Light Duty	4,500	1
729324	1"	Twist Knot End Brush	1/4" Shank	Heavy Duty	20,000	1
729338	1"	Crimped End Brush	1/4" Shank	Light Duty	20,000	1
729346	3"	Crimped Wheel Brush	1/4" Shank	Light Duty	20,000	1

## WIRE BRUSH ADAPTER



Part Number	Description	RPM	Qty
729379	Multi-Thread Adapter 5/8"-11 to M10x1.25 & M10x1.50	20,000	1

## WIRE BRUSH MERCHANDISERS

Part Number	Dia.	Description	Qty
HAP5	Merch.	Wire Wheel Merchandiser 1" - 4" sizes	28
HAP7	Merch.	Wire Wheel Merchandiser Large Diameter emphasis 6" - 8"	20





P/N: 729218



P/N: 729216

## CUP BRUSHES



P/N: 729302

Part Number	Dia.	Description	Arbor	Application	RPM	Qty
729200	3"	Twist Knot Cup Brush With Protective Guard	5/8"-11 an M14 x 2.0	Heavy Duty	15,000	1
729201	3"	Twist Knot Cup Brush	5/8"-11 and M14 x 2.0	Heavy Duty	15,000	1
729203	3"	Twist Knot Cup Brush With Protective Guard	M10 x 1.25 and M10 x 1.50	Heavy Duty	15,000	1
729205	4"	Twist Knot Cup Brush	5/8"-11 and M14 x 2.0	Heavy Duty	9,000	1
729210	3"	Crimped Cup Brush With Protective Guard	5/8"-11 and M14 x 2.0	Light Duty	13,000	1
729211	3"	Crimped Cup Brush	5/8"-11 and M14 x 2.0	Light Duty	13,000	1
729212	3"	Brass Coated Cable Crimped Cup Brush	5/8"-11 and M14 x 2.0	Light-Medium Duty	13,000	1
729213	3"	Crimped Cup Brush With Protective Guard	M10 x 1.25 and M10 x 1.50	Light Duty	13,000	1
729216	3"	Brass coated Cable Crimped Cup Brush With Protective Guard	5/8"-11 and M14 x 2.0	Light-Medium Duty	13,000	1
729218	3"	Brass coated Cable Crimped Cup Brush With Protective Guard	M10 x 1.25 and M10 x 1.50	Light-Medium Duty	13,000	1
729220	4"	Twist Knot Cup Brush With Protective Guard	5/8"-11 and M14 x 2.0	Heavy Duty	9,000	1
729225	6"	Twist Knot Cup Brush	5/8"-11	Heavy Duty	6,000	1
729230	4"	Crimped Cup Brush With Protective Guard	5/8"-11 and M14 x 2.0	Light Duty	9,000	1
729234	6"	Crimped Cup Brush	5/8"-11	Light Duty	6,000	1
729236	4"	Brass coated Cable Crimped Cup Brush With Protective Guard	5/8"-11 and M14 x 2.0	Light-Medium Duty	9,000	1

## Sandpaper Information Guide

### What is Grit?

"Grit" is a reference to the number of abrasive particles per inch of sandpaper. The lower the grit the rougher the sandpaper and conversely, the higher the grit number the smoother the sandpaper. This makes sense if you imagine how small the particles on an 80-grit sandpaper would need to be to fit into a 1" square. Sandpaper is referred to by the size of its grit.

### GRIT APPLICATION CHART

#### 40 - 60 Grit / Coarse

Heavy sanding and stripping, roughing up the surface.

#### 80 - 120 Grit / Medium

Smoothing of the surface, removing smaller imperfections and marks.

#### 150 - 180 Grit / Fine

Final sanding pass before finishing the wood.

#### 220 - 240 Grit / Very Fine

Sanding between coats of stain or sealer.

#### 220 - 240 Grit / Very Fine

Removing dust spots or marks between finish coats.

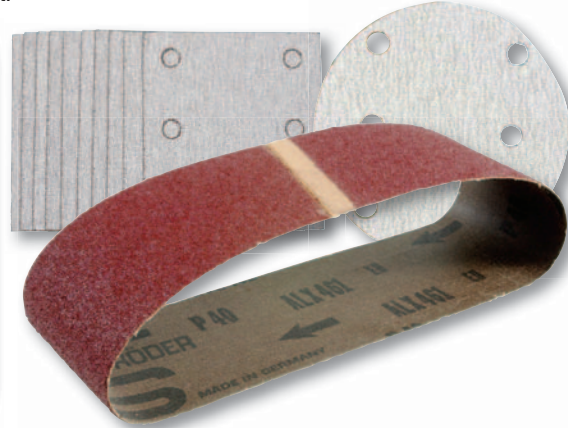

### 3" x 21" BELTS

#### For Belt Sanders

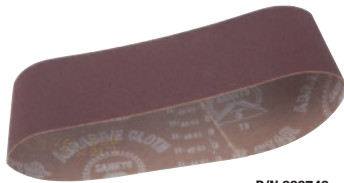

P/N 939746

Part Number	Description	Grit	Qty
753241	3" x 21" Sanding Belt	P40	5
753242	3" x 21" Sanding Belt	P60	5
753243	3" x 21" Sanding Belt	P80	5
753244	3" x 21" Sanding Belt	P100	5
753245	3" x 21" Sanding Belt	P120	5
939745	3" x 21" Sanding Belt	AA150	10
939746	3" x 21" Sanding Belt	AA180	10
939747	3" x 21" Sanding Belt	AA240	10
939748	3" x 21" Sanding Belt	AA320	10
939749	3" x 21" Sanding Belt	AA400	10

### 4" x 24" BELTS

#### For Belt Sanders



P/N 995557

Part Number	Description	Grit	Qty
995550	4" x 24" Sanding Belt	WA40	10
995551	4" x 24" Sanding Belt	WA60	10
995555	4" x 24" Sanding Belt	WA150	10
995556	4" x 24" Sanding Belt	WA180	10
995557	4" x 24" Sanding Belt	WA240	10
995558	4" x 24" Sanding Belt	AA40	10
995559	4" x 24" Sanding Belt	AA60	10
995560	4" x 24" Sanding Belt	AA80	10
995561	4" x 24" Sanding Belt	AA100	10
995562	4" x 24" Sanding Belt	AA120	10
995563	4" x 24" Sanding Belt	AA150	10
995564	4" x 24" Sanding Belt	AA180	10
995565	4" x 24" Sanding Belt	AA240	10
995566	4" x 24" Sanding Belt	CC40	10
995567	4" x 24" Sanding Belt	CC60	10
995568	4" x 24" Sanding Belt	CC80	10
995569	4" x 24" Sanding Belt	CC100	10
995570	4" x 24" Sanding Belt	CC120	10
995571	4" x 24" Sanding Belt	CC150	10
995572	4" x 24" Sanding Belt	CC180	10
995573	4" x 24" Sanding Belt	CC240	10

## 5" SANDPAPER

For Random Orbit Sanders

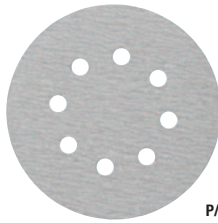

P/N 308519

Part Number	Dimensions	Type	Grit	Qty
310353	5" Round	Perforated Self Adhesive Stick-On	AA60	10
308516	5" Round	Perforated Hook & Loop Velcro	AP40	5
308517	5" Round	Perforated Hook & Loop Velcro	AP60	5
308518	5" Round	Perforated Hook & Loop Velcro	AP80	5
308519	5" Round	Perforated Hook & Loop Velcro	AP120	5
308520	5" Round	Perforated Hook & Loop Velcro	AP180	5
308521	5" Round	Perforated Hook & Loop Velcro	AP240	5
308522	5" Round	Perforated Hook & Loop Velcro	AP320	5
308523	5" Round	Perforated Hook & Loop Velcro	AP400	5

## 5" SANDING DISC PADS

For Random Orbit Sanders

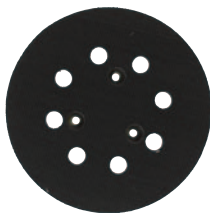

P/N 324209

Part Number	Dimensions	Type	Qty
310356	5" Round	Perforated Self Adhesive Stick-On	1
324209	5" Round	Hook & Loop 8-Hole	1
309419	5" Round	Hook & Loop 8-Hole	1

## 1/4 SHEET SANDPAPER

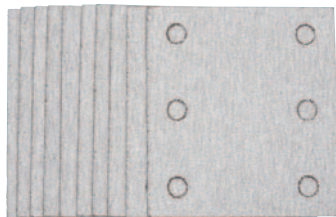

P/N 310348

Part Number	Dimensions	Grit	Qty
<b>Perforated Clip-On</b>			
310341	4-1/2" x 5-1/2"	AA60	10
310342	4-1/2" x 5-1/2"	AA100	10
310343	4-1/2" x 5-1/2"	AA150	10
310354	4-1/2" x 5-1/2"	PAD	1
<b>Perforated Hook &amp; Loop</b>			
310344	4-3/8" x 4"	AA60	10
310345	4-3/8" x 4"	AA100	10
753044	4-1/2" x 4"	AA100	10
310346	4-3/8" x 4"	AA150	10
310355	4-3/8" x 4"	PAD	1
<b>Perforated Self-Adhesive</b>			
310347	4-3/8" x 4"	AA60	10
310348	4-3/8" x 4"	AA80	10
310350	4-3/8" x 4"	AA120	10
310351	4-3/8" x 4"	AA150	10
310352	4-3/8" x 4"	AA180	10
321978	4-3/8" x 4"	PAD	1

## 1/2 SHEET SANDPAPER



P/N 750754



P/N 750765

Part Number	Dimensions	Grit	Qty
<b>Perforated Hook &amp; Loop</b>			
750754	4-1/2" x 9"	AA100	10
750756	4-1/2" x 9"	AA150	10
750758	4-1/2" x 9"	AA220	10
<b>Non-Perforated Hook &amp; Loop</b>			
750763	4-1/2" x 9"	AA100	10
750765	4-1/2" x 9"	AA150	10
750767	4-1/2" x 9"	AA220	10

Accessories

## 7" SANDING DISCS

For Disc Sanders and Grinders

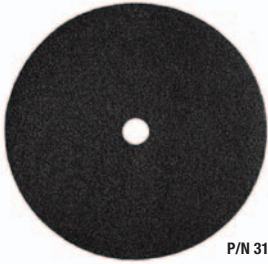

P/N 314092

Part Number	Description	Grit	Qty
314086		CP24	10
314087		CP30	10
314088		CP36	10
314089		CP40	10
314090		CP50	10
314091		CP60	10
314092		CP80	10
314093		CP100	10
314094		CP120	10
953256Z	7" Sanding Disc Set	CP24, CP30, CP50, CP80, CP120, Pad, Washer & Nut, Spanner Wrench	8

## 5" SANDING DISCS

For Grinders

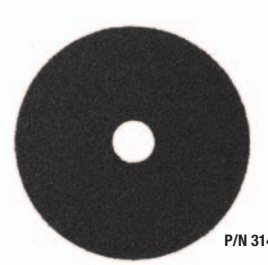

P/N 314067

Part Number	Grit	Qty
308516	AP40	5
308517	AP60	5
308518	AP80	5
308519	AP120	5
308520	AP180	5
308521	AP240	5
308522	AP320	5
308523	AP400	5
314062	CP16	10
314063	CP20	10
314064	CP24	10
314065	CP30	10
314066	CP36	10
314067	CP40	10
314068	CP50	10
314069	CP60	10
314070	CP80	10
314071	CP100	10
314072	CP120	10

## 4-1/2" SANDING DISCS

For Grinders



P/N 314099

Part Number	Grit	Qty
314095	CP16	10
314097	CP24	10
314098	CP30	10
314099	CP36	10
314100	CP40	10
314101	CP50	10
314102	CP60	10
314103	CP80	10
314104	CP100	10
314105	CP120	10

## 4" SANDING DISCS

For Grinders



P/N 314056

Part Number	Grit	Pack Qty
314053	CP24	10
314054	CP30	10
314055	CP36	10
314056	CP40	10
314057	CP50	10
314058	CP60	10
314059	CP80	10
314060	CP100	10
314061	CP120	10

## 7" SANDING ACCESSORIES

Part Number	Description	Grit	Qty
953255	7" Rubber Pad	N/A	1
953254P	Washer (U5) & Nut (8-11)	N/A	1
937913Z	Spanner Wrench	N/A	1

## 7" POLISHING ACCESSORIES



P/N 725401

Part Number	Description	Material	Dimensions	Qty
949103	Tie-On Polishing & Buffing Bonnet	100% 4-ply tufted twisted wool knit	7-1/2" x 1-1/2"	1
725400	Tie-On Polishing & Buffing Bonnet	50/50 wool/acrylic blend lambswool clear luster knit	7-1/2" x 1-1/2"	1
725401	Hook & Loop Polishing & Buffing Bonnet	100% 4-ply tufted twisted wool knit	7-1/2" x 1-1/2"	1
725402	Hook & Loop Polishing & Buffing Bonnet	50/50 wool/acrylic blend lambswool clear luster knit	7-1/2" x 1-1/2"	1

## 5"/6" POLISHING PADS

For Random Orbit Sanders



P/N 308515

Part Number	Description	Dimensions	Qty
308515	Hook & Loop Buffing Pad	5" Round	1
312518	Hook & Loop Polishing Sponge	6" Round	1



## Pipe Thread Standards

**NPT** National Standard Pipe Taper Thread (A sealant compound or Teflon tape must be used for a leak-free seal)

**FNPT** Female National Standard Pipe Thread

**MNPT** Male Standard National Pipe Thread

### Notes:

Pipe Size is the accepted industry designation and does not refer to either the inside or the outside diameter (ID or OD) of a pipe or a fitting.



## Industrial Interchange Series (Military Specification A-A-59439)

- Plated steel couplers have hardened steel balls and stainless steel springs.
- Brass couplers have stainless steel balls and springs.
- Coupler plugs are heat treated and zinc plated to reduce wear on critical mating surfaces.
- Industrial Interchange couplers and plugs interchange with Hansen, Foster, Aro, Parker and others.

**WARNING:** Couplers and plugs are intended for use on compressed air lines only. Maximum rated working pressure is 300PSI



## NR90AEPR

3-1/2" Plastic Collated Framing Nailer

- Lightweight and well-balanced for easy maneuverability
- Tool free depth of drive adjustment to flush drive or countersink into varying material
- Selective actuation for either sequential or "bump" fire nailing with a simple flip of a switch for tool-less transitions

See page 65 for more information



## FUEL RODS

### For Gas Nailers



P/N 728981

P/N 728982D

Part No.	Description	Applicable Tools
728981	Short Fuel Rods (4 pack)	HITACHI NT50GS, NT65GS, NT65GB, NT65GA
728982	Tall Fuel Rods (2 packs)*	HITACHI NR90GC, NR90GC2, NR90GR, NR90GR2, NC40G
728985B8	12 oz Degreaser/Cleaner (8 pack)	ALL HITACHI GAS AND PNEUMATIC NAILERS
728986B12	4 oz Lubricant Oil (12 pack)	ALL HITACHI GAS NAILERS

\* Must order in multiples of 6

## Pneumatic Fittings

**Plugs:** All steel plugs are heat treated to reduce wear on critical mating surfaces. Fully interchangeable with plugs made by other manufacturers.

**Couplers:** Couplers have hardened steel balls to ensure connection holds tight under the most rugged applications. Standard couplers have a built in sleeve guard to prevent accidental disconnect, and stainless steel springs.



P/N 190151



P/N 191041

## INDUSTRIAL COUPLERS & PLUGS

### "M" Milton Style



P/N 190001

Part No.	Specification		NPT		Material
	5 Pack	Series	Style	Size	
190001	Industrial 1/4"	Plug	1/4"	Male	Plated Steel
191051	Industrial 1/4"	Coupler	1/4"	Male	Plated Steel
190011	Industrial 1/4"	Plug	1/4"	Female	Plated Steel
191001	Industrial 1/4"	Coupler	1/4"	Female	Plated Steel
190051	Industrial 1/4"	Plug	3/8"	Male	Plated Steel
191021	Industrial 1/4"	Coupler	3/8"	Male	Plated Steel
190061	Industrial 1/4"	Plug	3/8"	Female	Plated Steel
191151	Industrial 1/4"	Coupler	3/8"	Female	Plated Steel

## INDUSTRIAL COUPLERS & PLUGS

### "H" Milton Style



P/N 190111

Part No.	Specification		NPT		Material
	5 Pack	Series	Style	Size	
190101	Industrial 3/8"	Plug	3/8"	Male	Plated Steel
191101	Industrial 3/8"	Coupler	3/8"	Male	Plated Steel
190111	Industrial 3/8"	Plug	3/8"	Female	Plated Steel
191111	Industrial 3/8"	Coupler	3/8"	Female	Plated Steel

## INDUSTRIAL 360° SWIVEL PLUGS

### Milton Style



P/N 190151

Part No.	Specification		NPT		Material
	Each	Series	Style	Size	
190131	Industrial 1/4"	Swivel Plug	1/4"	Male	Plated Steel
190161	Industrial 1/4"	Swivel Plug	1/4"	Female	Plated Steel
190141	Industrial 1/4"	Swivel Plug	3/8"	Male	Plated Steel
190171	Industrial 1/4"	Swivel Plug	3/8"	Female	Plated Steel
190151	Industrial 3/8"	Swivel Plug	3/8"	Male	Plated Steel
190181	Industrial 3/8"	Swivel Plug	3/8"	Female	Plated Steel

Accessories

## AUTOMOTIVE COUPLERS & PLUGS

### Standard "P" (Tru-flate/Parker) Style



P/N 191041

Part No.	Specification		NPT		Material	
	5 Pack	Series	Style	Size		Thread
190021	Automotive 3/8"	Plug	1/4"	1/4"	Male	Plated Steel
191011	Automotive 3/8"	Coupler	1/4"	1/4"	Male	Plated Steel
190031	Automotive 3/8"	Plug	3/8"	3/8"	Male	Plated Steel
191031	Automotive 3/8"	Coupler	3/8"	3/8"	Male	Plated Steel
190041	Automotive 3/8"	Plug	3/8"	3/8"	Female	Plated Steel
191041	Automotive 3/8"	Coupler	3/8"	3/8"	Female	Plated Steel

## AUTOMOTIVE COUPLERS & PLUGS

### Standard "T" (Tru-flate/Parker) Style



P/N 190091

Part No.	Specification		NPT		Material	
	5 Pack	Series	Style	Size		Thread
190091	Automotive 1/4"	Plug	1/4"	1/4"	Male	Plated Steel
191121	Automotive 1/4"	Coupler	1/4"	1/4"	Male	Plated Steel
190121	Automotive 1/4"	Plug	1/4"	1/4"	Female	Plated Steel
191131	Automotive 1/4"	Coupler	1/4"	1/4"	Female	Plated Steel
190071	Automotive 1/4"	Plug	3/8"	3/8"	Male	Plated Steel
190081	Automotive 1/4"	Plug	3/8"	3/8"	Female	Plated Steel

## AUTOMOTIVE STYLE 360° SWIVEL PLUGS

### Tru-flate/Parker Style



P/N 190221

Part No.	Specification		NPT		Material	
	Each	Series	Style	Size		Thread
190221	Automotive 1/4"	Swivel Plug	1/4"	1/4"	Male	Plated Steel
190251	Automotive 1/4"	Swivel Plug	1/4"	1/4"	Female	Plated Steel
190201	Automotive 1/4"	Swivel Plug	3/8"	3/8"	Male	Plated Steel
190231	Automotive 1/4"	Swivel Plug	3/8"	3/8"	Female	Plated Steel
190211	Automotive 3/8"	Swivel Plug	3/8"	3/8"	Male	Plated Steel
190241	Automotive 3/8"	Swivel Plug	3/8"	3/8"	Female	Plated Steel

## UNIVERSAL 3-WAY COUPLERS

### Fits Aro, Automotive and Industrial Type plugs



P/N 191071



P/N 191081

Part No.	Specification		NPT		Material	
	5 Pack	Series	Style	Size		Thread
191061	Combo 1/4"	Coupler	1/4"	1/4"	Female	Machine Brass
191071	Combo 1/4"	Coupler	1/4"	1/4"	Male	Machine Brass
191081	Combo 1/4"	Coupler	3/8"	3/8"	Female	Machine Brass
191091	Combo 1/4"	Coupler	3/8"	3/8"	Male	Machine Brass



## Hose / Hose Accessories / Brass Hose Fittings / Hose Kits



P/N 19407



P/N 19411



P/N 19408

### Rubber Hose:

- 300psi 4 to 1 burst ratio
- Flexible in cold temperatures
- Oil & abrasion resistant
- Extended life over PVC
- Superior durability

### PVC Hose:

- 300PSI 4 to 1 burst ratio
- Oil & abrasion resistant
- Spiral reinforced for durability
- Flexible kink resistant design

### Polyurethane Hose:

- 300PSI 3 to 1 burst ratio
- 40% lighter than PVC
- Remains flexible in cold weather
- Spiral reinforced for durability
- Highly kink resistant
- Includes bend restrictors for added durability

## RUBBER AIR HOSES



P/N 19407

Part No.	Size		Material	Fitting Type	
	Each	Diameter			Length
19400		3/8"	50'	Rubber	N/A
19407		3/8"	100'	Rubber	N/A

## PVC AIR HOSES



P/N 19411

Part No.	Size		Material	Fitting Type	
	Each	Diameter			Length
19405		3/8"	100'	PVC	N/A
19406		3/8"	50'	PVC	N/A
19410F		1/4"	50'	PVC	Industrial
19410FA		1/4"	50'	PVC	Automotive
19411F		1/4"	100'	PVC	Industrial
19411FA		1/4"	100'	PVC	Automotive

## POLYURETHANE AIR HOSES



P/N 19412F

Part No.	Size		Material	Fitting Type	
	Each	Diameter			Length
19408		3/8"	50'	Polyurethane	N/A
19409		3/8"	100'	Polyurethane	N/A
19412F		1/4"	50'	Polyurethane	Industrial
19412FA		1/4"	50'	Polyurethane	Automotive
19412QP		1/4"	50'	Polyurethane	Green Thread/No Fittings
19413F		1/4"	100'	Polyurethane	Industrial
19413FA		1/4"	100'	Polyurethane	Automotive
19413QP		1/4"	100'	Polyurethane	Green Thread/No Fittings

## PVC HOSE KITS

- Crimped on compression ring
- Screw on quick connectors
- 3/8" NPT Thread Male Swivels
- Plugs and Couplers

Part No.	Size		Material	Fitting Type	
	Each	Diameter			Length
19403		3/8"	50'	PVC	Automotive
19700		3/8"	50'	PVC	Industrial

Accessories

## HOSE REPAIR KITS

### Hose Repair Kits

Includes: 1 Brass Barb Splicer,  
1 Threaded Male end and  
3 Stainless Steel Hose Clamps



P/N 19200

Part No.	Hose Size		
	I.D	O.D.	Width
192001	1/4"	1/4" to 5/8"	5/16"
192011	3/8"	3/8" to 7/8"	5/16"

## ADAPTERS AND SWIVELS



P/N 192141

Part No.	Spec.	NPT: Inlet/Outlet		Material	
		Type	Size		Thread
19021	Hex Nipple		3/8" / 3/8"	Male/Male	Brass
192031	Tee		3/8" / 3/8"	Female/Female	Brass
192141	Uni-Swivel		1/4" / 1/4"	Female/Male	Aluminum

## 3-IN-1 MANIFOLD



P/N 192071

Part No.	Spec.	NPT: Inlet/Outlet		Material	
		Type	Size		Thread
192071	Manifold		1/4" / 1/4"	Female/Female	Aluminum
192081	Manifold		3/8" / 1/4"	Female/Female	Aluminum

## COMPRESSED AIR LINE SAFETY BLOWER



P/N 192041

Part No.	Specifications		NPT	Material	
	Consumed/Delivered	Tip Pressure	Thread	Internal	External
192041	8 (cfm) / 11 (cfm)	30 (psi)	1/4" FNPT	Chrome	Brass

## DIRECT AIR LINE CHUCKS



P/N 192091

Part No.	Type	NPT		Material
		Size	Thread	
192091	Ball Foot Chuck	1/4"	Female	Brass

## LUBRICANTS



P/N 19205

Part No.		Description
Each	12 Pack	
	19205	Air Tool Oil, 8oz bottles
	19210B	Synthetic Air Compressor Oil, 8oz bottles- Sae5w50
	19213	Winter Weight Air Tool Oil, 16oz bottles
876212		Pneumatic Tool Lubricant, 1-quart

## FILTERS & REGULATORS



P/N 19300



P/N 19301



P/N 19304



P/N 19309

Part No.	Specification			
	Type	NPT: Size/Thread	PSI	Material
19300	Mini Regulator w/Gauge	1/4"/Female	0-160	Zinc/Brass/Plastic
19301	5-Micron Mini Filter	1/4"/Female	0-150	Zinc/Polycarbonate
19302	Regulator w/Gauge	3/8"/Female	0-160	Zinc/Brass/Plastic
19304	Micro Fog Lubricator	3/8"/Female	0-150	Zinc/Polycarbonate
19308	Mini Piggyback w/Gauge	3/8"/Female	0-160	Zinc/Polycarbonate
881508	Pressure Gauge	1/8"/Male	0-160	Steel/Brass



## THREAD SEAL TAPE



Part No.	Description
725297T	Thread Seal Tape 1/2" x 260"

## Battery Information Guide

### The Importance of Voltage and Amp Hour

#### Voltage (V)

- Directly corresponds to the power output of a cordless tool
- Higher Voltage = More Power

#### Amp Hour (Ah)

- Unit of measurement for battery capacity, or how long the battery will run before needing to be recharged, depending on the application
- Higher Amp Hour = Greater Run Time, More Weight
- Hitachi continues to provide amp hour ratings as it remains an important specification to adequately match the battery to the job



### Battery Chemistry

Lithium Ion (Li-Ion)	Nickel-Cadmium (Ni-Cd)	Nickel-Metal Hydride (Ni-MH)
1.5 or 3.0 Ah	1.2, 1.4 or 2.0 Ah	3.0 Ah
Best power-to-weight	Consistent discharge rates	Fast charging
Steady level of power throughout charge	Most affordable	Performs well under rigorous conditions
1/2 the weight of Ni-Cd and Ni-MH	Considerable power	Long shelf life
3X longer battery life		Environmentally friendly

### Li-Ion Slide Vs. Li-Ion Post Style Batteries

#### Slide Style

- Allows for a more ergonomic handle for increased comfort by removing the post insert



#### Post Style

- Backwards compatible with Hitachi Ni-Cd and Ni-MH post-style batteries



## LITHIUM ION BATTERIES



P/N 330139



P/N 326241

Voltage	Stock Code	Number	Type	Capacity
3.6 V	326263	EBM315	Li-Ion Post	1.5 Ah
10.8 V/12V Peak	329370	BCL1015	Li-Ion Post	1.5 Ah
	331065	BCL1015	Li-Ion Post	1.5 Ah
14.4V	327728	BCL1415	Li-Ion Post	1.5 Ah
	326823	BCL1430	Li-Ion Post	3.0 Ah
	330140	BSL1415X	Li-Ion Slide	1.5 Ah
	329901	BSL1430	Li-Ion Slide	3.0 Ah
18V	327730	BCL1815	Li-Ion Post	1.5 Ah
	326241	EBM1830	Li-Ion Post	3.0 Ah
	330139	BSL1815X	Li-Ion Slide	1.5 Ah
	330067	BSL1830	Li-Ion Slide	3.0 Ah
25.2 V	328034	BSL2530	Li-Ion Slide	3.0 Ah

## NICKEL CADMIUM (NiCd) BATTERIES



P/N 325292

Voltage	Stock Code	Number	Type	Capacity
7.2 V	325292	EB714S	Ni-Cad Post	1.2 Ah
9.6 V	310451	EB9B	Ni-Cad Post	2.0 Ah
	321654	EB912S	Ni-Cad Post	1.2 Ah
12 V	322434	EB1212S	Ni-Cad Post	1.2 Ah
	318240	FEB12S	Ni-Cad Post	1.4 Ah
	324360	EB1214S	Ni-Cad Post	1.4 Ah
	320386	EB1220BL	Ni-Cad Post	2.0 Ah
14.4 V	324367	EB1414S	Ni-Cad Post	1.4 Ah
	315129	EB14B	Ni-Cad Post	2.0 Ah
18 V	324365	EB1814SL	Ni-Cad Post	1.4 Ah
	322437	EB1820	Ni-Cad Post	2.0 Ah
24 V	322881	EB1820L	Ni-Cad Post	2.0 Ah
	316965	EB24B	Ni-Cad Post	2.0 Ah
	319806	EB2420	Ni-Cad Slide	2.0 Ah

## NICKEL METAL HYDRIDE (NiMH) BATTERIES



P/N 322877

Voltage	Stock Code	Number	Type	Capacity
14.4 V	318371	EB1430H	Ni-Mh Post	3.0 Ah
18 V	322877	EB1830HL	Ni-Mh Post	3.0 Ah
	323902	EB1830H	Ni-Mh Post	3.0 Ah
24 V	319807	EB2430HA	Ni-Mh Slide	3.0 Ah

Accessories

## POST-STYLE BATTERY CHARGERS



P/N UC10SFL



P/N UC18YRL

Stock Code	Voltage	Time	Type	Battery
UC3SFL UC3SML	3.6 V	30 min	Li-Ion Post	326263
UC10SFL UC10SFLP	10.8 V	50 Min	Li-Ion Post	329370/331065
UC14YFA	7.2 V	30 Min - 50 Min	Ni-Cad Post	325292
	9.6 V	30 Min - 50 Min	Ni-Cad Post	310451/ 321654
	12 V	30 Min - 50 Min	Ni-Cad Post	322434/318240/324360/320386
	14.4 V	30 Min - 50 Min	Ni-Cad Post	324367/315129
	14.4 V	70 Min	Ni-Mh Post	318371
UC18YG	7.2 V	30 Min - 50 Min	Ni-Cad Post	325292
	9.6 V	30 Min - 50 Min	Ni-Cad Post	310451/ 321654
	12 V	30 Min - 50 Min	Ni-Cad Post	322434/318240/324360/320386
	14.4 V	30 Min - 50 Min	Ni-Cad Post	324367/315129
UC18YGL	14.4 V	30 Min - 50 Min	Ni-Cad Post	324365/322437/322881
	14.4 V	30 Min - 65 Min	Li-Ion Post	327728/326823
	18 V	30 Min - 65 Min	Li-Ion Post	327730/326241
UC18YGL2	7.2 V	35 Min	Ni-Cad Post	325292
	9.6 V	35 Min - 60 Min	Ni-Cad Post	310451/ 321654
	12 V	35 Min - 60 Min	Ni-Cad Post	322434/318240/324360/320386
	14.4 V	35 Min - 60 Min	Ni-Cad Post	324367/315129
		90 Min	Ni-Mh Post	318371
	18 V	40 Min - 90 Min	Li-Ion Post	327728/326823
		40 Min - 90 Min	Li-Ion Post	327730/326241
	35 Min - 60 Min	Ni-Cad Post	324365/322437/322881	
UC18YRL UC18YFL	7.2 V	35 Min - 60 Min	Ni-Mh Post	322877/323902
	7.2 V	20 Min	Ni-Cad Post	325292
	9.6 V	20 Min - 30 Min	Ni-Cad Post	310451/ 321654
	12 V	20 Min - 30 Min	Ni-Cad Post	322434/318240/324360/320386
	14.4 V	20 Min - 30 Min	Ni-Cad Post	324367/315129
		45 Min	Ni-Mh Post	318371
	18 V	45 Min	Li-Ion Post	327728 / 326823
		40 Min - 90 Min	Li-Ion Post	327730/326241
35 Min - 60 Min	Ni-Cad Post	324365/322437/322881		
90 Min	Ni-Mh Post	322877/323902		
UC24YFA	7.2 V	30 Min	Ni-Cad Post	325292
	9.6 V	35 Min - 50 Min	Ni-Cad Post	310451/ 321654
	12 V	35 Min - 50 Min	Ni-Cad Post	322434/318240/324360/320386
	14.4 V	40 Min - 50 Min	Ni-Cad Post	324367/315129
		70 Min	Ni-Mh Post	318371
	18 V	40 Min - 50 Min	Ni-Cad Post	324365/322437/322881
		70 Min	Ni-Mh Post	322877/323902
50 Min	Ni-Cad Post	316965		
UC24YJ	7.2 V	9 Min	Ni-Cad Post	325292
	9.6 V	9 Min - 14 Min	Ni-Cad Post	310451/ 321654
	12 V	9 Min - 14 Min	Ni-Cad Post	322434/318240/324360/320386
	14.4 V	9 Min - 14 Min	Ni-Cad Post	324367/315129
		28 Min	Ni-Mh Post	318371
	18 V	9 Min - 18 Min	Ni-Cad Post	324365/322437/322881
		28 Min	Ni-Mh Post	322877/323902
24V	20 Min	Ni-Cad Post	316965	

## SLIDE-STYLE BATTERY CHARGERS



P/N UC18YGSL

Stock Code	Voltage	Time	Type	Battery
UC18YGSL	14.4 V	40 Min - 90 Min	Li-Ion Slide	330140/329901
	18 V	40 Min - 90 Min	Li-Ion Slide	330139/330067
UC18YRSL	14.4 V	45 Min	Li-Ion Slide	329901
	18 V	20 - 45 Min	Li-Ion Slide	330139/330067
UC24YFB	24 V	50 Min	Ni-Cad Slide	319806
		70 Min	Ni-Mh Slide	319807
UC36YRL	25.2 V	60 Min	Li-Ion Slide	328034

## FLASHLIGHTS AND LANTERNS

Part No.	Description	Battery Voltage	Light Bulb P/N
UB10DL	Cordless Flashlight	10.8V-12V Peak	330267
UB12D	Cordless Torch Light	9.6V- 12V	314424
UB12DLC	Cordless Lantern	9.6V- 12V	323339
UB18DLC	Cordless Lantern	14.4V-18V	323339
UB24D	Cordless Torch Light	24V	320546
UB18D	Cordless Flashlight	14.4V-18V	318767
UB18DAL	Flashlight- Slide Battery Type	14.4V-18V	318767



P/N UB10DL



P/N UB18DAL



P/N UB18DLC

## MITER SAW ATTACHMENTS

### Crown Molding

Part number	Description
322713	CRN MOLDING STOPPER (L) ASS'Y
322714	CRN MOLDING STOPPER (R) ASS'Y
322712	CRN MOLDING VISE ASS'Y C10FCE
321434	CROWN MOLDING VISE ASSY C10FSB
321388	CROWN MOLDING VISE ASSY
321390	CROWN MOLDING STOPPER HOLDER
321374	CROWN MOLDING SUPPORT (L) ASSY
321373	CROWN MOLDING SUPPORT (R) ASSY
323545	CRN MOLDING VISE ASS'Y C12LC
323546	CRN MOLDING STOPPER (L) ASS'Y
323547	CRN MOLDING STOPPER (R) ASS'Y

### Stoppers & Vises

Part number	Description
998835	STOPPER C8FB2 C10FS
307559	WISE & KNOB ASSY C8FB2
317541	WISE ASSY C10FCD
317642	WISE ASSY C10FCD
321370	WISE ASSY C10FSB
305174	HORIZONTAL VISE ASS'Y C12FSA
310747	WISE ASSEMBLY C12FSA
323657	HOLDER ASS'Y C12LC C12LCH
988897	WISE C15FB
322952	WISE ASS'Y C10FCE C10FCH
322957	WISE (B) ASS'Y C10FCE C10FCH
323677	WISE ASS'Y C12LC C12LCH C12FCH
324464	HOLDER ASS'Y C12LSH C12RSH
998844	HOLDER C8FB2 C8FB C10FS
998991	STOPPER (A) C8FB

### Guide Assembly

Part number	Description
974661	GUIDE ASSY C15FB C10FB C10FA

### Fences



Part number	Description
310657	SLIDE FENCE ASSY C8FB2
322711	SUB FENCE ASS'Y C10FCE C10FCH
321387	SUB FENCE (A) C10FSH
310881	SLIDE FENCE ASSY C10FS
324454	SUB FENCE (B) ASS'Y C12LSH
324455	SUB FENCE (A) C12LSH C12RSH
329464	SUB FENCE ASS'Y C8FSE C8FSHE

### Table Extensions

Part number	Description
322710	EXTENSION WING ASSY C10FCE/H
322956	EXTENSION WING C10FCE C10FCH C10FCE2 C10FCH2
317542	EXTENSION WING ASSY C10FCD
321553	EXTENSION WING ASSY C10FSB/H
320277	EXTENSION WING ASSY C12FSA
323523	EXTENSION WING ASSY C12LC
324369	EXTENSION WING ASSY C12LSH
998834	EXTENSION WING C12LSH C12RSH
998866	EXTENSION WING ASSY C8FB2/10FS



## MITER SAW ATTACHMENTS

### Dust Collection

Part number	Description
998845	DUST BAG FOR C8FB/C8FB2 C10FS
311034	DUST BAG ASSY C10FC/FC2/FCD
322955	DUST BAG (BLACK) C10FCH C12FDH C12LDH
976478	DUST BAG C15FB C10FA
998857	ADAPTER DUCT HOSE C8FB2

### Guard

Part number	Description
998984	ADJUSTABLE GUARD C8FB2

### Collars

Part number	Description
976819	COLLAR (B) for D25.4Hole C10FS
976451	COLLAR(C) FOR 1" ARBOR TO 5/8"
976442	COLLAR (A) 4 D25.4 HOLE C8FB2

### Wrenches

Part number	Description
940543	BOX WRENCH 3/8" C10FS C8FB2
985051	BOX WRENCH 17mm C15FB C10FA/FB

## WORKSTATION ATTACHMENTS

Part number	Description
726285	SUPPORT ARM ASS'Y UU610CZ
726200	SUPPORT ARM ASS'Y UU610
726201	WORK SUPPORT ASSEMBLY UU610
726206	SUPPORT BEAM 18" UU610 UU610CZ
726210	KNOB, SWIVEL STOP UU610
726224	BASERAIL ENDCAP UU610 UU610CZ
726225	FOOT INSERT UU610 UU610CZ
726222	LEG ASS'Y UU610 UU610CZ
726279	STOP COLLAR UU610
726284	KNOB, EXTENSION STOP UU610
726262	WORK SUPPORT BRACKET UU610
726257	SUPPORT BEAM 12" UU610 UU610CZ
726244	SAW ADAPTER PLATE UU610

## CIRCULAR SAW ATTACHMENTS



Part number	Description
302756	RIP GUIDE C6DC2 C18DMR C6DC
302691	RIP GUIDE C7SB/BD/D/YA/SC C8
302478	BOX WRENCH 13MM C7D
957683	WRENCH 10x13mm C7BD C7SB
319296	DUSTBAG ASSY C7YA
319297	DUST GUIDE C7YA
302690	DUST COLLECTOR SET C7BD C7SB
303377	DUST COLLECTOR FOR C8
321100	CASE CARRYING, PLASTIC C6DC2
321188	CASE CARRYING, PLASTIC C7BD2

Accessories

## PLANER ATTACHMENTS



P/N F20BS

Part number	Description
958893Z	3-5/8" HSS PLANER BLADE 1pair
200002	6" TCT PLANER BLADE 1pair
963450Z	6-5/8" HSS PLANER BLADE 1pair
F20BS	PLANER STAND P20SB P20SBK
958842Z	GUIDE ASSY P20SB
972043	WRENCH 10x13mm SPANNER P12RA

## ROUTER ATTACHMENTS

Part number	Description
956927Z	CHUCK SLEEVE 1/2"x1/4" M12V
956928Z	CHUCK SLEEVE 1/2"x3/8" M12V
956914	STRAIGHT GUIDE ASS'Y M12V/SA
303355	TEMPLATE GUIDE D40mm M12V TR12

## CORDED DRILL ATTACHMENTS



P/N D13DS

Part number	Description
982794Z	D HANDLE D13
327488	DRILL CHUCK & KEY RJ133-16L
D10DS2	DRILL STAND for D10 D13 DRILLS
D13DS	DRILL STAND for D13 D15 DRILLS

## HAMMER ATTACHMENTS



P/N 308776

Part number	Description
305449	DUST COLLECTION ADAPTER 4"
308774	DUST COLLECTION ADAPTER DH24PD
317341	DUST COLLECTION ATTACHM DH40MR
308776	DUST COLLECTION ATTACHMENT
324949	DUST COLLECTION GUARD 5" METAL
985373	DUST COVER DH38YE

## GRINDER ATTACHMENTS



P/N 328740

Part number	Description
932666Z	COLLET CHUCK 1/4" GP2
985136	COLLET CHUCK 1/8" GP2
932627	COLLET CHUCK 6mm GP2
985135	COLLET CHUCK 8mm GP2
937928Z	WHEEL WASHER (A) D16 G12SE2
937922P	WHEEL WASHER (B) G13SC2
937835Z	WHEEL WASHER (C) G10SR G10SD1
937834Z	WHEEL WASHER G10SR2/SR/SD1
938332Z	WRENCH SPANNER G12SR G12SE
937913Z	WRENCH SPANNER G18MR G13SC2
986383	Dust collector for 4" grinder
328740	Dust collection hood, 5"
328744	Dust collection hood, 9"
953254P	WASHER NUT 5/8"-11 UNC THREAD
937960Z	WHEEL GUARD 7" G18SR/SE/SE2
937984Z	WHEEL GUARD G23MR G23SCY
936558Z	4" RUBBER PAD FOR SANDING

## CARRYING CASES



P/N329585



P/N 326511



P/N 333356

Part number	Description
C102405H	CASE CARRYING, STEEL H55SCK
328351	CASE CARRYING, PLASTIC CJ18DL
328845	CASE CARRYING, PLASTIC CM5SB
329993	CASE CARRYING, PLASTIC CR10DL
327054	CASE CARRYING, PLASTIC CR13VBY
329585	CASE CARRYING, PLASTIC DB10DL
327883	CASE CARRYING, PLASTIC DH22PG
324820	CASE CARRYING, PLASTIC DH45MR
323713	CASE CARRYING, PLASTIC G23MR
326511	CASE CARRYING, PLASTIC H45MRY
329553	CASE CARRYING, PLASTIC WH10DL
327727	CASE, CARRYING DS14DFL DS18DFL
325679	CASE, CARRYING PLASTIC DH30PC2
328206	CASE, CARRYING PLASTIC G18DL
328703	CASE, PLASTIC CARRYING DH18DL
326489	CASE, PLASTIC CARRYING DH40MRY
333356	CASE, ROLLING PLASTIC H65SD2

Accessories

## HITACHI 2-STROKE ENGINE OIL (Perfect Mix)

For use in any air-cooled, 2-stroke engine

### Features:

- Fuel Stabilizer
- Smokeless Formulation
- Extends Engine Life
- FD Rated



Perfect Mix Oil meets ISO-L-EGD and JASO (FD) performance levels

Part Number	Bottle Size	Details	Case Qty	Packaging
110001	2.6 oz	Quick and convenient for mixing 1 gallon of fuel	48	Wrapped in 6 packs
110002	6.4 oz	Quick and convenient for mixing 2.5 gallons of fuel	48	Wrapped in 6 packs
110003	16 oz	No Mess, No Guess, with Hitachi self-measuring	12	Individual bottles
110006	2.6 oz	Quick and convenient for mixing 1 gallon of fuel	24	Tear off carton for retail
110008	6.4 oz	Quick and convenient for mixing 2.5 gallons of fuel	24	Tear off carton for retail



P/N 110006



P/N 110008



P/N 110003

## HITACHI QUIET TWIST TRIMMER LINE

### Features:

- Up to 50% Noise Reduction
- Reduces Fuel Consumption
- Extends Engine Life
- Increases RPM's

Part Number	Line Diameter	Length	Case Qty
113000	.080" / 2.0mm	Large Donut 320'/97m (0.8 lbs)	12
113001	.095" / 2.4mm	Large Donut 230'/70m (0.8 lbs)	12
113002	.105" / 2.7mm	Large Donut 185'/56m (0.8 lbs)	12
113003	.130" / 3.3mm	Large Donut 120'/36m (0.8 lbs)	12
113004	.095" / 2.4mm	Medium Spool 685'/208m (2.4 lbs)	9
113005	.105" / 2.7mm	Medium Spool 550'/167m (2.4 lbs)	9
113006	.130" / 3.3mm	Medium Spool 360'/190m (2.4 lbs)	9
113007	.095" / 2.4mm	Large Spool 1140'/347m (4 lbs)	6
113008	.105" / 2.7mm	Large Spool 920'/280m (4 lbs)	6
113009	.095" / 2.4mm	Tube 16"/406m Pre-cut strands, 52 pc	24
113010	.105" / 2.7mm	Tube 16"/406m Pre-cut strands, 44 pc	24



P/N 113004

P/N 113001

P/N 113009

## TRIMMER HEADS



Part Number	Description	Type
32308	No-Brainer - Includes 6 Strands of .095" line (Straight Shaft Trimmers)	Quick-Load
32307	No-Brainer - Includes 6 Strands of .095" line (Curved Shaft Trimmers)	Quick-Load
746751	Brain® 2000 - Holds 18' of .095" line	Fully Automatic
746851	4" Straight Shaft	Semi-Automatic
746852	4" Curved Shaft	Semi-Automatic
746451	5"	Semi-Automatic
746353	6"	Semi-Automatic
746290	Aluminum - Holds 15' of .105" line (Straight Shaft Trimmers)	Manual
746280	Aluminum - Includes 10 Strands of .130" line (Straight Shaft Trimmers)	Fixed
112002	No Brainer - Includes 6 Strands of .095" line (Straight and Curved Shaft Trimmers)	Quick-Load

## ATTACHMENTS



Part Number	Description	Fits Model
CGHT*	Articulating Hedge Trimmer Attachment	CG22EADSLP
CGPS*	Pole Saw Attachment	CG22EADSLP
CGPE*	Portable Edger Attachment	CG22EADSLP
CGMC*	Mini-Cultivator Attachment	CG22EADSLP
CGGT	Grass Trimmer Attachment	CG22EADSLP
748504	Blade Conversion Kit	CG22EABSLP, CG22EADSLP, CG22EASSLP, CG24EASPSL, CG27EASPSL
746191	Single Shoulder Strap	
746291	Deluxe Double Shoulder Strap - Padded, Hip Protector	

\* See page 82 for more information on Hitachi's Smartfit trimmer and attachments



## ALABAMA

Alabama Jack Div of Beerman Professional Tool Repair	1140 5th Ave. North 6180 Hwy 31	Birmingham	35203	205 251-8156	EPCO
Fastening Solutions, Inc	102 Refreshment Place	Calera	35040	800 327-8187	EPC
Power Tool Supply	1713 Creighton Ave	Decatur	35602	256 350-0816	P
Fastening Solutions, Inc	111 Commercial Lane	Decatur	35601	256 350-0079	EPCO
Grand Rental Station, Inc.	1613 Florence Blvd.	Dothan	36303	334 794-2593	P
Fastening Solutions, Inc	10275 Highway 13	Florence	35630	256 766-4849	E
Engineered Maintenance Service	7234 Governors West	Haleyville	35565	205 486-5649	P
Southern Fastening Systems	9059 Madison Blvd. Ste #C	Huntsville	35806	256 837-2950	EPC
Southern Fastening Systems	3747 Government Blvd Ste B-3	Madison	35758	256 772-8936	PC
Fastening Solutions, Inc	3504 Halls Mill Rd	Mobile	36693	251 661-1219	PC
Fastening Solutions, Inc	3075 Selma Hwy	Mobile	36693	251 661-9468	P
Southern Fastening Systems	635 Fairgrounds Rd.	Montgomery	36108	334 284-8300	P
Southern Fastening Systems	212 Commerce Pkwy	Muscle Shoals	35662	256 381-3628	PC
Kentec Megatools	2134 A Pelham Parkway	Pelham	35124	205 733-8501	PC
Fastening Solutions, Inc	2665 Pelham Parkway	Pelham	35124	205 733-1553	PC
Martin Industrial Supply	141 Commerce Ct	Pelham	35124	205 420-2990	P
Gulf Coast Power Tool	5651 Hwy 90 Suite D	Pelham	35124	205 733-9292	ECO
Advanced Compressed Air Technologies	6161 Rangeline Rd. Suite D	Theodore	36582	251 653-9912	EPC
		Theodore	36582	251 443-5455	C

## ALASKA

Alaska Industrial Hardware	2192 Viking Dr.	Anchorage	99501	907 562-6151	P
SECNO Alaska Inc	877 East Dowling Road	Anchorage	99518	907 561-2175	EPCO
Fairbanks Aero Service	1915 Ada St.	Fairbanks	99709	907 479-6666	EPCO
Denali Industrial Supply	2800 Cushman St	Fairbanks	99701	907 452-4524	EP
Mat-su Tool Repair, LLC	522 Mckinley St	Wasilla	99654	907 357-0647	EPCO

## ARIZONA

Desert Air & Electric, LLC	281 S Ironwood, Ste 2	Apache Junction	85120	480 288-2112	EPCO
CMC Builders Supply	80 East Township Ave. P O Box 849	Colorado City	86021	928 875-2887	EPC
Copper State Bolt & Nut Co.	1841 E. Huntington Dr	Flagstaff	86004	928 774-3237	EPC
A & B Supply	4648 Hwy 95	Fort Mohave	86426	928 704-1704	EPC
Tri State Tool Repair	5010 Hwy 95 Suite 18	Ft. Mohave	86426	928 788-3420	EPCO
Banner Tool Service	6741 N 57th Ave	Glendale	85301	623 842-0800	EPC
A & B Electric Motors & Supply	1081 N. Lake Havasu Ave.	Lake Havasu City	86403	928 453-3185	EPC
Copper State Bolt & Nut Co.	537 Lake Havasu Ave N #102	Lake Havasu City	86403	928 854-6989	EPC
Copper State Bolt & Nut Co.	923 E. Impala Ave	Mesa	85204	480 926-2566	EPC
First Fasteners, Inc.	930 W Birchwood #C-3	Mesa	85210	480 969-1944	P
Chandler Equipment Sales	1124 S. Center St.	Mesa	85210	480 964-1871	E
Carlson Systems	1171 W. Industrial Park Dr. Unit B	Nogales	85621	520 281-2216	EPC
Copper State Bolt & Nut Co.	1060 N Mariposa	Nogales	85621	520 281-4986	EPC
Copper State Bolt & Nut Co.	8936 N. 79th Ave	Peoria	85345	623 334-4951	EPC
Arizona Armature Service	4641 S 33rd St	Phoenix	85040	602 276-4434	E
Copper State Bolt & Nut Co.	3602 N. 35th Avenue	Phoenix	85017	602 455-9141	EPC
Carlson Systems	3315 E. Broadway	Phoenix	85040	602 304-2229	EPC
White Cap	2432 South 6th St	Phoenix	85004	602 256-6900	EPC
Arizona Power Tool Service	15206 N Cave Creek Rd. Ste. A	Phoenix	85022	602 485-4067	EPC
Copper State Bolt & Nut Co.	3831 E. Broadway Rd.	Phoenix	85040	602 437-8677	EPC
Glenn's Tool Service	2149 E. Indian School Rd.	Phoenix	85016	602 264-6203	EPC
Copper State Bolt & Nut Co.	3637 N 34th Ave	Phoenix	85017	602 272-2384	EPC
Altaquip	54 North 45th Ave Suite C	Phoenix	85043	602 233-1550	EPCO
Copper State Bolt & Nut Co.	17023 N Black Canyon Freeway	Phoenix	85023	602 548 1873	EPC
AMW Packaging	4415 S 32nd St	Phoenix	85040	602 268-1266	P
Prescott Power Tool	1050 Willow Creek Road, #1	Prescott	86301	928 445-2628	EPCO
Copper State Bolt & Nut Co.	8175 E. Raintree #6	Scottsdale	85260	480 367-9051	EPC
Precision Tool & Const. Supply	4857 East 29th St.	Tucson	85711	520 745-1100	EPCO
Copper State Bolt & Nut Co.	3162 Noth Freeway Industrial Loop	Tucson	85705	520 882-0611	EPC
Western Tool Inc.	702 S Campbell Ave	Tucson	85719	520 884-0504	EPCO
Carlson Systems	1475 W. Glenn St.	Tucson	85705	520 792-4391	EPC
TRS Equipment Sales & Rental	4620 W Ina Rd	Tucson	85741	520 744-6333	EPC
White Cap Industries	3875 N Commerce Dr	Tucson	85705	520 792-9448	P
Copper State Bolt & Nut	811 East 47th St	Tucson	85713	520 770-2480	EPC
Copper State Bolt & Nut Co.	2995 S. Shari Ave	Yuma	85365	928 317-8110	EPC

E= Electric P= Pneumatic C= Compressor O= Outdoor Power Equipment

## ARKANSAS

Fastening Solutions, Inc	3202A Military Rd	Benton	72015	501 860-7600	P
Southern Fastening Systems	901 SE 21st St	Bentonville	72712	479 271-0255	PC
Tool Room, The	508 Marsh Ave.	El Dorado	71730	870 863-3036	EC
Tool Service Company	5732 Wheeler Ave.	Fort Smith	72901	479 648-3125	EPCO
Tool Source, The	950 Airport Rd.	Hot Springs	71913	501 760-5000	EPCO
Southern Fastening Systems	3531 Cental Ave Suite A	Hot Springs	71913	501 623 8665	PC
Southern Fastening Systems	3105 Prosperity Dr.	Jonesboro	72404	870 935-2232	P
Tool Central	1809 E Parker Road	Jonesboro	72401	870 972-6864	EC
Southern Fastening Systems	212-B Commercial Ave.	Lowell	72745	479 770-6640	P
Southern Fastening Systems	10624 Otter Creek East Blvd	Mabelvale	72104	501 455-2247	PC
Southern Fastening Systems	10624 Otter Creek East Blvd. Suite B	Mabelvale	72210	501 455-2247	PC
Partners Airless Sales & Service	6100 Getty Drive Suite R	North Little Rock	72117	501 833-3306	EPCO
Tool Central	1907 E Kings Highway	Paragould	72450	870 236-3800	EC
Tool Doctor, The	2010 Industrial Dr.	Pocahontas	72455	870 892-8665	EC
Elder Hayes	5659 N. Thompson St.	Springdale	72764	479 756-1330	P
White Cap	3670 Elm Springs Rd.	Springdale	72762	479 927-0400	EPC
Fastening Solutions, Inc	13243 Puppy Creek Rd Suite #12	Springdale	72762	479 419-9339	P
Southern Fastening Systems	3710 Jefferson Ave.	Texarkana	71854	870 773-1866	EPC
B & C Repair	5545 Carpenter Rd	Texarkana	71854	870 772-5827	PCO

## CALIFORNIA

Precision Parts	9350 Baseline Rd. Suite D	Alta Loma	91701	909 989-5889	P
Anaheim Tool Repair	3121 E La Palma Avenue	Anaheim	92806	714 630-9240	EP
D B Service Center	1540 N State College	Anaheim	92806	714 533-3222	EPC
Humboldt Fasteners Inc.	5100 Valley East Blvd #1	Arcata	95521	707 822-0209	EPCO
Allied Building Products	325 Mt Vernon Ave	Bakersfield	93307	661 631-8474	P
Folsom Electric	16823 Bellflower Blvd	Bellflower	90706	562 920-1006	EPCO
Truitt and White Lumber Co.	1930 2nd Ave	Berkley	94710	510 841-0511	EPC
American Fastening Systems Inc.	591 Constitution Ave. Unit D	Camarillo	93012	805 388-1552	EPC
Spark Tools	7841 Alabama Ave #17	Canoga Park	91304	818 884-6821	EPC
Northern California Tool & Supply	829 W 8th St	Chico	95928	530 343-5585	EP
Lee's Tools	1924 N Long Beach Blvd	Compton	90221	310 639-1900	EPCO
CES-Concord	1170G Burnett Ave.	Concord	94520	925 827-1011	EPC
Altaquip	5159 Commercial Circle Units D & E	Concord	94520	925 609-6307	EPCO
Red-E-Rentals	2075 Harbor Blvd	Costa Mesa	92627	949 646-7401	EPCO
California Electric Service	612 S. Shoppers Lane	Covina	91723	626 915-4935	EPC
Delano Equipment Rental	600 Glenwood Street	Delano	93216	661 721-8096	EPC
Tool Depot	1441 Encinitas Blvd	Encinitas	92024	760 943 9120	EPC
Toolmart	2750 Auto Parkway Suite 13	Escondido	92029	760 480-1444	EPC
Mack's Tool Repair	1043 E Mission	Fallbrook	92028	760 451-1078	EPC
White Cap	5780 E. Shields Ave	Fresno	93727	559 294-9000	EPC
Outlet Fasteners	4767 E. McKinley Ave.	Fresno	93703	559 255-8855	P
All Tool Service and Supply	1571 N Maple	Fresno	93703	559 252-2879	EPC
Ideal Saw Works	351 "O" St	Fresno	93721	559 237-0809	EPC
Fastenal	3204 East Garrett	Fresno	93706	559 495-0146	EPC
Glendale Power Tool	921 S Verdugo Road	Glendale	91205	818 244-9277	EPC
Tool Shack, Inc.	229 S. Glendale Ave	Glendale	91205	818 956-1144	EPC
Tool Shed, The	654 Maltman Dr Suite B	Grass Valley	95945	530 477-1185	EPC
Acme Tool Repair	452 Moore Lane	Healdsburg	95448	707 431-0444	EPC
California Electric Service	22500 Muirlands Blvd. #B	Lake Forest	92630	949 586-9440	EPC
Valley Construction Supply	45346 N Trevor	Lancaster	93534	661 948-5074	EPC
Tool Tech	4647 Las Positas Rd Ste. A	Livermore	94550	925 443-7922	EP
California Nail & Supply Co.	415 Mountain Vista Parkway	Livermore	94550	925 443-7239	EPC
Minit Tool	4170 E. Washington Blvd	Los Angeles	90023-3402	323 264-7008	EPCO
Furber Saw Shop	895 Howe Road	Martinez	94553	925 229-3774	EPC
Freedom Fastening Systems, Inc.	P.O. Box 206	Meridian	95957	530 671-2222	EPC
Stanislaus Electric Motor	504 River Road	Modesto	95351	209 523-8269	E
Fastener USA	909 B N Emerald Ave	Modesto	95351	209 522-4951	P
Tools-R-Us	9055 Central Ave	Montclair	91763	909 626-9500	EPCO
Empire Mowers, Inc.	22410 Alessandro Blvd.	Moreno Valley	92553	951 697-6688	PC
Bucknall Power Tool	11910 Vose St	North Hollywood	91605	818 765-0228	EPC
3-D Fasteners Plus	1100S. Grove Ave Bldg F2-8	Ontario	91761	909 673-0222	P
3-D Fasteners Plus	1070 N Batavia #A	Orange	92867	714 639-6950	P
Kennedy Equipment, Inc	748 N Lemon St	Orange	92867	714 771-7324	ECO
Electric Motor Service	200 East Fifth St	Oxnard	93030	805 483-4233	E
A A A Saw & Service	38644 6th Street East	Palmdale	93550	661 947-5886	E

E= Electric P= Pneumatic C= Compressor O= Outdoor Power Equipment

Service

## CALIFORNIA (cont.)

A J Contractors Supply	2450 Ramada Dr.	Paso Robles	93446	805 239-4317	PC
3-D Fasteners Plus	8423 Rosemead Blvd	Pico Rivera	90660	562 861-4353	P
Don Hoban	3790 Omec Circle	Rancho Cordova	95742	916 383-2024	EP
Western Tool Supply	5138 Caterpillar Rd	Redding	96003	530 242-0870	P
Redding Tool & Equipment	4305 A Caterpillar Rd # 1	Redding	96003	530 241-7968	EPC
Ken's Tool & Supply	1751 Marlborough Ave.	Riverside	95207	951 686-2542	EPC
American Tool Repair	4235 Pacific St Unit E	Rocklin	95677	916 919-3559	EPCO
Valley Tool Repair	4131 B Power Inn Road	Sacramento	95826	916 381-6300	EPCO
Contractor's Tool Repair	4237 So. Market Ct. Suite E	Sacramento	95834	916 922-6007	EPC
K-119 Tools of California	925 San Mateo Ave	San Bruno	94066	650 588-0160	EPC
Tool Depot	3799 Gaines St.	San Diego	92110	619 220-7111	EPCO
South Coast Equipment Repair	9660 Chesapeake Dr	San Diego	92123	858 569-0929	EPC
Craig & Green Power Tool Service	1680 Evans Ave	San Francisco	94124	415 642-8698	EPCO
White Cap Ind.	200 Jennings St	San Francisco	94124	415 821-5500	EPC
Blaze Fireplaces	101 Cargo Way	San Francisco	94124	415 495-2002	EPC
Western Tool Supply	245 S. Van Ness	San Francisco	94103	415 864 1985	P
San Gabriel Tools	1848 A S. San Gabriel Box	San Gabriel	91776	626 280-4525	EPC
Custom Tool Repair	2081 Bering Dr Unit 4	San Jose	95112	408 225-0333	EPCO
J P Tool Repair	3440-A Sacramento Dr	San Luis Obispo	93401	805 544-7152	EPC
Lawnmower City Corp.	2115 S. Bristol Street	Santa Ana	92704	714 794-9894	O
White Cap	1922 Pomona St	Santa Ana	92705	714 259-1517	EPC
Buena Tool Company	433 Laguna Street	Santa Barbara	93101	805 963-3885	EPC
Jim Klippel Tool Repair	424 Laguna St	Santa Barbara	93101	805 963-0020	EPC
Altaquip	15058 Shoemaker Ave	Santa Fe Springs	90670	562 404-2483	EPCO
Central City Tool Supply	2230 South Depot St. Unit D	Santa Maria	93455	805 614-9111	EPCO
Mead Clark Lumber Company #1	2667 Dowd Drive	Santa Rosa	95407	707 576-3333	P
Don Hoban Co.	3440 Standish Ave	Santa Rosa	95407	707 588-9406	EP
Tool Works	1431 East 28th St.	Signal Hill	90755	562 988-9150	EPCO
Simi Tool Repair	4470 Industrial St.	Simi Valley	93063	805 584-8138	EP
Ted's Electric	800 Emerald Bay Rd. #C	So. Lake Tahoe	96150	530 541-3225	EPC
Alpine Power Equipment	2770 Lake Forest Road P.O. Box 18	Tahoe City	96145	530 583-0600	EPCO
Toolmart. Inc.	28011 Jefferson St.	Temecula	92590	959 676-5210	EPC
T A Tools	12180 Ridgecrest Rd. Ste.418	Victorville	92395	760 881-3800	EPC
Christiansen Fasteners	1512 Shuey Ave	Walnut Creek	94596	925 932-8399	EPC
MSCR Tools	6618-A Westminster Blvd	Westminster	92683	714 898-9383	EPC
Kelco Fasteners & Tool Repair	730 N. George Washington Blvd.	Yuba City	95993	530 671-1575	EPC

## COLORADO

White Cap	14900 East 39th Ave	Aurora	80011	303 373-2273	EPC
Carlson Systems	890 Elkton Drive Suite 107	Colorado Springs	80907	719 593-8886	EPC
White Cap	4127 North Sinton Road	Colorado Springs	80907	719 260-0619	EPC
Kevco Tool Repair & Sales	1676 S 21st St	Colorado Springs	80904	719 635-8830	EPC
Carlson Systems	5150 Havana St. Unit D	Denver	80239	303 574-1500	EPC
Empire Staple Co.	1710 Platte St.	Denver	80202	303 433-6803	EPC
A Pro Tool, Inc.	1950 W. 13th Ave., Unit 2	Denver	80204	303 623-3743	EPC
Alpine Lumber Co.	5800 N. Pecos St.	Denver	80233	303 458-8733	PC
Altaquip	4199 Oneida St Unit H	Denver	80216	303 339-1350	EPCO
Copper State Bolt & Nut Co.	4880 Geneva St	Denver	80238	303 371-5766	EPC
G & S Tool Clinic	916 Chambers Ave. Suite A P O Box 2112	Eagle	81631	970 328-6282	EPC
Colorado Fasteners & Spec Tool	34510 Hwy 6 P O. Box 279	Edwards	81632	970 926-3301	EPC
Copper State Bolt & Nut	13365 James E. Casey Ave	Englewood	80112	303 799-1804	EPC
Workfitters Tool & Safety	1554 Riverside Ave	Fort Collins	80524	970 482-9930	E
Tools for Living	1301 Grand Ave Suite 5	Glenwood Springs	81601	970 945-5760	EPC
Professional Tool Service	2420 1-70 Business Loop	Grand Junction	81501	970 242-1224	EPC
Carlson Systems	937 Des Moines Ave	Loveland	80537	970 669-6070	EPC
Connective Systems & Supply Inc.	5718 Wright Drive	Loveland	80538	970 663-0304	EP
Colorado Fasteners	11450 N Cherokee St #B2	Northglenn	80234	303 450-2833	EPCO
Pueblo West Rental Center	579 E. Enterprise Dr.	Pueblo West	81007	719 647-2071	EPCO
Colorado Saw & Tools, Inc.	388 E. Industrial Blvd.	Pueblo West	81007	719 547-2346	EPCO
A-1 Rental	7080 W 38th Ave	Wheat Ridge	80033	303 424-4456	EPCO

## CONNECTICUT

Tibbys Electric Motor Service	40 Taylor Ave.	Bethel	06801	203 748-4694	EPC
Mamsco Construction Supply LLC	9 Tipping Drive	Branford	06405	203 481-9833	EPC
Action Engine Machining	61 McKinley Ave	Bridgeport	06606	203 367-6056	CO
Duo-Fast Northeast	22 Tolland St	East Hartford	06108	860 289-6861	EPC

E= Electric P= Pneumatic C= Compressor O= Outdoor Power Equipment



## CONNECTICUT (cont.)

QTR, Inc.	39 Wedgewood Drive	Jewett City	06351	860 376-5634	EP
Colony Hardware Supply	15 Stiles St.	New Haven	06512	203 466-5252	E
Watertown Tool Repair	28 Main St.	Oakville	06779	203 596-1344	EPC
Western Tool Supply	907 Boston Post Rd	Old Saybrook	06475	860 388 5440	P
Utility Electric Service	255 Chapel Rd	South Windsor	06074	860 246-7271	EPCO
R & D Services, LLC	45 Old Turnpike Rd	Southington	06489	860 628-5205	EPCO
Gottier Small Engine Repair	427 Tolland Stage Rd.	Tolland	06084	860 875-2802	EPCO
Altaquip	2 Toelles Rd Suite 9	Wallingford	06492	203 741-1000	EPCO

## DELAWARE

Mid Atlantic Fasteners	27519 Hodges Lane Unit P	Dagsboro	19939	302 732-1399	P
Eagle Nail & Tool	1061 N Walnut St , Rte113	Milford	19963	302 430-0840	EPC
Mechanics Paradise	2335 N Dupont Hwy.	New Castle	19720	302 652-8863	E
Eagle Nail & Tool	325 S. Dupont Hwy.	New Castle	19720	302 328-4888	EPC
Appliance Servicenter	3317B Old Capital Trail	Wilmington	19808	302 994-6259	E

## FLORIDA

Tool Doctor, The	502 36th St. W.	Bradenton	34205	941 746-2958	EPC
Hughes Tool Supply	111 N Central Drive	Brandon	33510	813 684-1124	EPC
Circle Service of S.W. Florida, Inc	1304 SE 10th St	Cape Coral	33990	239 772-1133	EPCO
Atlas Construction Equipment Services	12001 49th St N, Suite 201	Clearwater	33762	727 299-0700	EPC
Caicos Exports, Inc	4450 SW 61st Ave Unit #1	Davie	33314	954 587-9433	EPC
C & C Power Tools Inc.	859 Mason Ave	Daytona Beach	32117	386 253-5815	EPC
Daytona Bolt & Nut Co.	815 N. Beach St.	Daytona Beach	32114	386 255-0248	EPC
JR's Tool Repair	1419 2nd Avenue	Deland	32724	407 832-7064	EPC
Fastening Solutions, Inc	285-A Azalea Dr	Destin	32541	850 837-0042	P
Southern Fastening Systems	1 Industrial Park Rd Ste F-1	Destin	32541	800 239-5595	PC
Broward Tool	3547 N Dixie Highway	Fort Lauderdale	33334	954 566-4114	EPC
Brinker Brown Fasteners	12290 Crystal Commerce Loop	Ft Myers	33966	239 939-3535	EPC
Gulf Coast Nail & Staple, Inc	17162-1 Alico Center Rd	Ft Myers	33912	239 489-0300	EPC
Gotham Staple	2070 Andrea Lane	Ft Myers	33912	239 489-0962	EPC
Altaquip	3350 SW 13th Ave	Ft. Lauderdale	33315	954 523-1041	EPCO
In A Minute Tool Repair Inc.	5424 NW 10 Terrace	Ft. Lauderdale	33309	954 553-7464	EPC
Gatlin Lumber & Supply Co.	57 Beal Parkway NE	Ft. Walton Beach	32548	850 243-9102	EPCO
441 Tool Repair	1975-A South Park Rd.	Hallandale	33009	954 981-8270	EPC
Creation Tool Co.	3865 East 4th Ave.	Hialeah	33013	305 836-7488	E
United Tool Corp	501 East 9th St	Hialeah	33010	305 884-3068	EPC
A A A Tool & Saw Service Inc.	1450 S State Rd 7	Hollywood	33023	954 989-7192	EPC
National Tool Supply	5725 W. Hallandale Beach Blvd.	Hollywood	33023	954 963-7222	EPC
Jim & Slim's	10901 SR 52	Hudson	34669	727 245-1185	EPC
Suncoast Power Tool Repair	9703 Amilia Dr Suite F1 Kronos Bus Park	Hudson	34667	727 697-0134	EPCO
North Florida Power Tool Repair Center	3543 Beaver St.	Jacksonville	32254	904 387-4455	EPCO
Tool Shack Inc	226 Edgewood Ave S	Jacksonville	32254	904 387-1466	EPC
Fastening Systems	11417 Saints Rd	Jacksonville	32246-6663	904 641-8909	EPC
North Florida Fastening	6666 Stuart Avenue	Jacksonville	32254	904 783-9809	EPC
World Electric Supply	569 Stuart Lane	Jacksonville	32254	904 378-4000	EPC
Altaquip	1141 US Hwy 41 NW	Jasper	32052	386 792-3313	EPCO
Kentec Megatools	1450 Cypress Drive	Jupiter	33458	561 746-1248	PC
Key West Electrical Repair	311 Margaret St	Key West	33040	305 296-8548	EC
Hughes Tool Supply	2222 S Combee Rd	Lakeland	33801	863 669-9417	EPC
Altaquip	3115 Drane Field Rd Unit 12	Lakeland	33806	863 648-2344	EPCO
Southern Industrial	4930 Drane Field Rd	Lakeland	33811	863 644-6557	P
Jim & Slims	13065 So Belcher	Largo	33773	727 535-5661	EPCO
Citrus Power Tool & Fastener	1919 W. Gulf to Lake Hwy.	Lecanto	34461	352 527-2016	EPCO
Hughes Tool Supply	1208 U S Hwy 41 North	Lutz	33549	813 949-0441	EPC
B & J Industrial Tool Repair	5603 Lake LeClare Rd	Lutz	33558	813 264-1716	E
Kentec Megatools	6112 NW 74th Ave	Miami	33166	305 592-1692	PC
Service Contractors Equipment	1087 SW 67th Ave	Miami	33144	305 265-5650	EPC
Soto's Tool Repair & Rental, Inc.	19200 SW 106 Ave. Bay #44	Miami	33157	305 971-5734	EPCO
Tools-N-More	3700 N.W. 54th	Miami	33142	786 270-5555	EPC
A-1 Tool Repair	1851 Blanding Blvd.	Middleburg	32068	904 282-3707	EPCO
E & W Tool and Supply	465 Fife Road	Mulberry	33860	863 425-3077	EPC
Power Tool Repair Co. Inc.	4750 Bayline Drive	N. Ft. Myers	33917	239 652-5786	EPC
Brinker Brown Fasteners	369 Industrial Blvd.	Naples	34104	239 643-3500	EPC
Tropical Construction Supply	14848 Old US 41 Suite 5	Naples	34110	239 594-1004	EPC
Tool Doctor	1825 N Magnolia Ave	Ocala	34475	352 622-5655	EPC

E= Electric P= Pneumatic C= Compressor O= Outdoor Power Equipment

## FLORIDA (cont.)

Debary Mower & Repair, Inc.	1104 Shadrick Dr.	Orange City	32763	386 775-7505	EPCO
G M Tool & Fastener	1631 Rock Springs Rd Unit 241	Orlando	32712	407 880-9901	E
Contractors Tool Service, Inc.	5409 Edgewater Drive	Orlando	32810	407 292-2808	EPC
Fastening Systems	9789 S Orange Blossom Tr	Orlando	32837	407 855-9773	EP
Grabber Orlando	3714 Silver Star Rd	Orlando	32808	407 297-7278	EPC
Profast Supply	8500 Parkline Blvd. Suite 114	Orlando	32809	407 585-5288	P
Fasteners Southeast	7635 Currency Drive	Orlando	32809	407 857-2261	EPC
Ken's Tool Repair	327 Parque Drive # 2	Ormond Beach	32174	386 566-0330	EPC
Jim & Slims	37724 US 19N	Palm Harbor	34684	727 934-2662	EPC
Hughes Tool Supply	32680 US Hwy. 19N	Palm Harbor	34684	727 785-9923	EPC
Bishop Supply	2420 Game Farm Rd	Panama City	32405	850 215-4090	EPC
Southern Fastening Systems	7512-B McElvey	Panama City Beach	32408	850 235-3035	PC
A Discount Tool Repair	3130 SW 19th St. Bay 448	Pembroke Park	33009	954 966-2137	EPC
Southern Fastening Systems	9601 N Old Palafox Bldg 4	Pensacola	32534	850 494-9066	PC
Escambia Electric Motor Sales & Service	1101 W. Main St	Pensacola	32501	850 432-1577	EPC
A A A Tool & Saw Service	4632 N Powerline Rd	Pompano Beach	33073	954 972-1381	EPC
Grabber Pompano Beach	1857 SW 3rd St	Pompano Beach	33069	954 971-4730	EPCO
TRA Repair Shop, Inc.	762 NE 42nd St	Pompano Beach	33064	954 781-7853	EPC
Elite Contractor Supply	2209 NW 30th Place	Pompano Beach	33069	954 971-5663	EPC
Tropical Construction Supply	18412 Paulson Dr.	Port Charlotte	33954	941 743-5863	EPC
Grabber Port St. Lucie	1519 SW Biltmore St.	Port St. Lucie	34983	772 878-2680	EPC
Citrus Power Tool & Fasteners	3422 US Hwy 98 W Suite 4	Santa Rosa	32459	850 267-0541	EPC
ASAP Enterprises of Sarasota	5377 McIntosh Ave	Sarasota	34233	800 940-2727	EPCO
Fastening Systems	279 Interstate Court	Sarasota	34240	941 379-0771	EPC
Wilson Fastener, Inc.	351 Interstate Ct. E	Sarasota	34240	941 378-1651	P
Mobile Tool Repair	2136 Hwy 2321	Southport	32409	850 271-1707	EPCO
R & R TOOL REPAIR	13591 LINDEN DRIVE	SPRING HILL	34609	352 263-3587	EPCO
Hughes Tool Supply	13140 Springhill Drive	Springhill	34609	352 686-2345	EPC
Ernie's Tools	20 South Dixie Hwy	St Augustine	32095	904 829-5712	EPC
Air Hydraulic Electric Service	515 22nd Street South	St Peteresburg	33712	727 526-4513	EPCO
Appliance Doctors	3166 SE Dixie Highway	Stuart	34997	772 287-6437	EPC
Cornerstone Tool & Fastener, Inc.	1110 Stuckey Ave	Tallahassee	32310	850 580-1200	P
Fastening Systems	10247 Windhorst Rd	Tampa	33619	813 740-8885	EPC
Fasteners Southeast	1212 N 39th St. Suite 300	Tampa	33605	813 247-5636	EPC
R & R Tool Inc	1202 S Congress Ave	West Palm Beach	33406	561 439-3846	P
Reliable Tool Service, Inc	6970 Wallis Road #1A	West Palm Beach	33413	561 689-1676	EPC
Tools-N-More	6537 Southern Blvd.	West Palm Beach	33413	561 689-8349	EPC
Florida Tool Repair	5821 Hallandale Beach Blvd	West Park	33023	954 892-2310	EPC

## GEORGIA

Nail Man, The	1521 Highway 92	Acworth	30102	678 574-8914	P
All Type Tool Repair	4659 South Main St	Acworth	30101	770 975-8700	EPCO
Little Enterprise	106 Nowhere Rd.	Athens	30601	706 548-4876	PC
Heely-Brown Co	1280 Chattahoochee Ave.	Atlanta	30318	404 352-0022	EP
Fastenal	6445 Fulton Ind Blvd	Atlanta	30336	404 346-4528	EPC
East Point Equipment Co. Inc	535 Milam Ave SE	Atlanta	30315	404 766-7027	EPCO
Tool Service Center	302 Walton Way	Augusta	30901	706 724-4803	E
R & S Industrial Supply	436 Hwy 247 P O Box 640	Bonaire	31005	478 328-2120	EPC
Mower Shop, The	6743 New Jessup Hwy	Brunswick	31523	912 261-9120	PC
Kentec Megatools	3670 Hutchinson Road Suite D	Cumming	30040	678 965-6797	PC
Dalton Vacuum & Power Tool	207 W King St Suite M	Dalton	30720	706 277-7717	EPC
Fastening Solutions, Inc	507 E Truman Street	Douglas	31533	912 383-6144	P
South City Tool, Inc.	5442 Frontage Road Suite 100	Forest Park	30297	404 608-9999	EPC
Altaquip	1925 Shiloh Rd. Bldg #3	Kennesaw	30144	770 422-4402	EPCO
Kentec Megatools	535 Indian Trail Rd.	Lilburn	30047	770 925-3674	PC
Southern Fastening Systems	4450 Tuck Rd	Loganville	30052	770 466-5676	PC
Southern Fastening Systems	4360 Lawrenceville Rd.	Loganville	30052	770 466-5080	PC
Fastening Solutions, Inc	1666 Roswell Rd Suite100	Marietta	30062	770 424-8200	P
Threads for the South	1076 King Industrial Drive	Marietta	30062	770 425-3787	E
Southern Fastening Systems	20 Tower Way Suite 3	Newnan	30265	678 423-0519	PC
Summit Supplies	6115 North Belt Dt Suite C	Norcross	30071	770 452-7577	EPC
Fastening Solutions, Inc	5192 Brook Hollow Parkway Suite F	Norcross	30082	770 623-4003	P
Fastening Solutions, Inc	456C Esdel Drive	Richmond Hill	31324	912 756-8301	P
Quality Tool Repair	5 Forsyth Dr.	Rockmart	30153	678 757-9692	EPCO
Maycrest Hardware Center Inc.	1609 Montgomery Crossroads	Savannah	31406	912 354-2045	EPC
Tool Box, The	439A Telfair Road P O Box 1176	Savannah	31415	912 238-5512	E

E= Electric P= Pneumatic C= Compressor O= Outdoor Power Equipment

## GEORGIA (cont.)

Southern Fastening Systems	218 Bourne Blvd Suite D	Savannah	31408	912 748-1572	PC
Savannah Toolhouse Inc., The	4408 Augusta Road	Savannah	31408	912 965-0500	EPC
Sanchez Tool Repair, Inc.	2301 Benson Poole Rd., Suite H	Smyrna	30082	678 293-6863	EPC
Kentec Inc	3250 Centerville Hwy	Snellville	30039	770 985-1907	PC
Southern Fastening Systems	1481 Hudson Bridge Rd. Suite F	Stockbridge	30281	770 389-4711	PC
Tifton Electric Motors	515 Vanderbilt Rd	Tifton	31794	229 382-4040	EPC
Tool Service Co	1810 Auger Dr, Units A-B	Tucker	30084	770 908-8022	EPC
Southern Fastening Systems	818 Hicks St.	Waycross	31501	912 285-1071	EPC
Kentec Megatools	9740 Main St.	Woodstock	30188	770 516-0744	PC

## HAWAII

J & J Lucas Repair	60 Kuhio St Bldg 4	Hilo	96720	808 935-4751	EPCO
LTM Services	481 Mohouli St	Hilo	96720	808 935-9635	EPCO
White Cap Construction	750 Kalaniana'ole Ave.	Hilo	96720	808 935-1098	EPC
Hawaiian Rent All	1946 S. Beretania St.	Honolulu	96826	808 949-3961	P
Slims Power Tools	1626 Republican St	Honolulu	96819	808 841-0902	EPCO
FKS Rental Sales	663 Kakoi St.	Honolulu	96819	808 836-2967	EPC
Industrial Cutters Co.	501 Sumner St, #104	Honolulu	96817-5331	808 538-3545	EPC
D & M Hydraulics Sales & Service	2825 Koapaka St. Unit 3	Honolulu	96819	808 671-2420	EPC
White Cap Construction	729 Ahua St.	Honolulu	96819	808 833-6602	EPC
White Cap Construction	220 Papa Place	Kahului	96732	808 873-8310	EPC
Slim's Power Tools, Inc.	142 Kalepa Pl	Kahului	96732	808 242-7878	EPC
FKS Rental Sales	441 Alamaha Street	Kahului	96732	808 871-7171	EPC
Service Rentals & Supplies	147 Kalepa Place	Kahului	96732	808 877-3410	EPC
Service Rentals & Supply	1587 Haleukana St	Lihue	96766	808 245-6360	EPC
Toolmaster Hawaii Inc	3061 Aukele St	Lihue Kauai	96766	808 246-1122	EPC

## IDAHO

K C Supply Co	5103 Irving St	Boise	83706	208 375-1313	EPCO
Western Tool Supply	375 North 5 Mile Rd	Boise	83703	208 322-8725	P
Western Wholesale & Supply	9989 W Emerald	Boise	83704	208 327-0010	EPC
Franklin Building Supply	11700 Franklin Rd.	Boise	83709	208 322-4567	PC
Coeur D Alene Power Tool	451 Cherry Lane	Coeur D Alene	83815	208 667-1158	EPC
Franklin Building Supply	113 Main St	Gooding	83330	208 934-8427	PC
Rossiter Electric Motor	1501 S. Capital Ave P O Box 2348	Idaho Falls	83403	208 529-3665	EPC
Hahn Tool Repair	2101 Main St	Lewiston	83501	208 743-1577	EPC
Idaho Tool & Equipment	452 Caldwell Blvd.	Nampa	83651	208 465-7533	EPC
Stone Lumber	412 2nd St S	Nampa	83651	208 466-2463	P
Albeni Falls Building Supply Inc.	520 Hwy 2	Oldtown	83822	208 437-3153	EPC
Ricks Electric Inc	1298 N. Yellowstone Hwy.	Rexburg	83440	208 356-3062	EPCO
Crandall Service Co.	2458 Warren St	Twin Falls	83301	208 733-8953	PC

## ILLINOIS

Hugo's Equipment & Repair	415 W Kay Ave	Addison	60101	630 628-7977	EPCO
Altaquip, Inc	694 Veterans Parkway, Unit C	Bolingbrook	60440	630 679-9300	EPCO
Illini Contractors Supply	706 West Bradley Ave P O Box 3967	Champaign	61820	217 355-0303	EPC
Pro Mar Staple & Nail	4508 N. Milwaukee	Chicago	60630	773 205-5496	EPC
R & J Construction Supply	1929 W Fulton	Chicago	60612	312 492-9990	EPC
Apollo Power Inc	6546 N Milwaukee Ave Suite B	Chicago	60631	773 782-6393	EPCO
R V Evans	2370 East Logan	Decatur	62521	217 423-3631	PC
Berland's House of Tools	1530 Centre Circle	Downers Grove	60515	630 620 9090	EPC
R & J Construction Supply	11902 North Street	Huntley	60143	847 669-1188	EPC
Berlands House of Tools	1695 New Lenox Rd.	Joliet	60433	815 722 2000	EPC
All Power Tool	15900 West 103rd St	Lemont	60439	630 343-6400	E
Berlands House of Tools	600 Oak Creek Drive	Lombard	60148	630 620-0026	EPC
R. V. Evans	7865 Burden Rd	Machesney Park	61115	815 877-1886	PC
Craig's	1601 E. Deyoung St.	Marion	62959	618 997-3379	EPC
Puig Tool & Equipment	10600 W. 191st Street	Mokena	60448	708 479-7017	EPCO
Berland's House of Tools	20254 N. Rand Rd.	Palatine	60074	847 540-9200	EPC
C & H Repair & Supply	2313-15 SW Adams Street	Peoria	61602	309 676-3333	EPC
Quincy Power Tool Repair	219 N. 10th Street P.O. Box 325	Quincy	62306	217 223-6300	EPC
Advanced Fastening Supply	3020 Forest View Rd	Rockford	61109	815 713-2556	EPC
Allen Staple & Nail Corp.	5520 W Touhy Unit J	Skokie	60077	847 674-0600	P
Midwestern Building Supply	508 E. Pearl St.	Tremont	61568	309 925-2911	EPC
R & J Construction Supply	30 W 180 Butterfield Road	Warrenville	60555	630 393-9020	EPC
Fasteners Unlimited	1000 Brown St Unit 4	Wauconda	60084	847 526-5921	EPC

E= Electric P= Pneumatic C= Compressor O= Outdoor Power Equipment

Service

## INDIANA

R & C Small Engine Repair	13630 Wicker Ave Suite A	Cedar Lake	46303	219 374-9660	EPCO
Hahn Systems	58172 Charlotte Ave	Elkhart	46517	574 293-0502	PC
Tri State Repair Service	1327 N Fares Ave	Evansville	47711	812 464-9341	EPC
Better Vac Tool and Appliance	1936 Fairfield Ave	Fort Wayne	46802	260 969-0626	EPC
Hahn Systems	8131 North Clinton St	Ft. Wayne	46825	260 489-0746	PC
Riteway Tool & Fastener Inc	5602 Elmwood Ave. #203	Indianapolis	46203-6037	317 786-8247	EP
Vamaco Inc/Tool & Equipment Service	6718 E. 38th Street	Indianapolis	46226	317 632-1594	EPCO
Hahn Systems	5830 W 74th St	Indianapolis	46278	317 243-3796	PC
Almac Air Tool	6011 East Hanna Ave Suite B	Indianapolis	46203	317 786-1355	EPCO
Fastenal	5851 Guion Rd.	Indianapolis	46254	317 216-1197	EPC
Hahn Systems	5305 Commerce Square Drive Suite A	Indianapolis	46237	317 888-4797	PC
White Cap	7130 W McCarty St	Indianapolis	46241	317 260-4300	EPC
Linc Systems	16540 Southpark Dr	Westfield	46074	800 513-9918	P

## IOWA

Trupke Electric Motor Service & Sales	600 Diagonal St.	Algona	50511	515 295-5242	EPC
Gierke-Robinson Co.	701 14th St	Bettendorf	52722	563 355-1120	E
Industrial Motors Inc.	1511 Mt Pleasant St	Burlington	52601	319 752-4917	EPC
White Cap	830 33rd Ave. SW Suite A	Cedar Rapids	52404	319 366-0731	EPC
Acme Tools	1943 Blair's Ferry Rd NE	Cedar Rapids	52402	319 363-2211	EPC
Gierke-Robinson Co.	3929 West River Drive	Davenport	52802	563 322-1725	E
White Cap	724 W. 2nd St.	Davenport	52802-1410	563 386-2922	EPC
Bobs Tools	1493 E Army Post Rd	Des Moines	50320	515 287-7542	EPC
White Cap	1631 Second Ave	Des Moines	50314	515 282-3323	EPC
Acme Tools	629 SW 9th St.	Des Moines	50309	515 244-4189	EPC
Peerless Supply, Inc.	1701 Guthrie Ave	Des Moines	50316	515 265-9905	E
Gierke-Robinson Co.	4490 Dodge St	Dubuque	52003	563 556-1185	E
Carlson Systems	1851 Destination Dr (NW 110th St)	Grimes	50111	515 986-5287	EPC
White Cap	2003 So. Gilbert St.	Iowa City	52240	319 339-0641	EPC
Gierke-Robinson Co.	1107 So. Riverside Dr	Iowa City	52246	319 358-5860	E
Bradley Tools & Fasteners, Inc.	6250 NW Beaver Drive Suite A-4 P O Box 271	Johnston	50131	515 331-0878	EPC
Blink Electric Motors	Rear 116 North 1st Ave.	Marshalltown	50158	641 752-3036	EPC
New Sioux City Iron Co., The	310 S. Floyd Blvd	Sioux City	51101	712 255-7696	EPC
Tool Depot, The	1510 Dace Ave.	Sioux City	51101	712 293-0274	EPC

## KANSAS

Midwest Electric	1620 Jones Ave P. O. Box 2655	Garden City	67846	620 275-6306	E
Big D's Rent All	P.O. Box 783	Hays	67601	785 625-2443	EPC
Dillon Material Co.	11201 Leavenworth Rd.	Kansas City	66109	913 721-2867	EPC
Fastenal	2401 Southwest Blvd	Kansas City	64108	816 531-5700	EPC
Overland Tool	7905 Nieman Rd	Lenexa	66214	913 599-4044	EPC
Metro Industrial Supply	713 N. Lindenwood Suite D	Olathe	66062	913 780-9494	P
Mid Kansas Tool Works	314 West Cloud St.	Salina	67401	785 825-6287	EPCO
Whiteley's Tool Repair	211 Northwest Norris Street	Topeka	66608	785 232-4535	EPCO
Carlson Systems	4245 West 31st St. South	Wichita	67215	316 942-1392	EPC
Nails Plus	3538 W 29th South #300	Wichita	67217	316 990-8665	EPC
Salisbury Supply	2825 S. West St.	Wichita	67217	316 944-0100	E

## KENTUCKY

Roman's Repair Center	1521 Old Louisville Rd	Bowling Green	42101	270 746-0857	EPC
Fry Fastening Systems	6702 Dixie Highway	Florence	41042	859 525-8715	EPC
City Electric Motor Co.	631 Kennedy Rd	Lexington	40511	859 254-5581	E
Kwik Set Fasteners Inc	1151 Commercial Dr	Lexington	40505	859 252-7518	EPCO
Tool Repair Service	1200 Goss Ave	Louisville	40217	502 635-6888	EPC
Hahn Systems	13205 Complete Ct.	Louisville	40223	502 451-0185	PC
Kwik-Set Fasteners	4006 Bishop Lane	Louisville	40218	502 969-5311	EPC
Cross Country Distributing, Inc.	405A N. English Station Rd.	Louisville	40223	502 245-8871	EPCO
DW Tool Sales & Service LLC	200 Lanark Pl	Louisville	40243	502 314-8663	P
Smiley's Air Tool	4552 Poplar Level Rd	Louisville	40213	502 966-3433	P

## LOUISIANA

Fastening Solutions, Inc	21434 Hwy 36	Abita Springs	70420	985 867-8900	P
Louisiana Tool Repair & Sales, Inc.	10227 Mammoth Ave.	Baton Rouge	70814	225 926-2220	EPCO
Ace Industrial Supply Co, Inc	2966 Weller Ave.	Baton Rouge	70805	225 357-1404	PC
Priceco Supply LLC	15151 Greenwell Springs Rd.	Greenwell Springs	70739	225 262-6245	EPCO

E= Electric P= Pneumatic C= Compressor O= Outdoor Power Equipment

## LOUISIANA (cont.)

Altaquip	1702 Church St.	Hammond	70401	985 340-0020	EPCO
Big Easy Tools	5626 Jefferson Highway	Harahan	70123	504 733-4138	EPCO
Robert's Repair, Rental & Retail, Inc.	4919 Hwy. 182	Houma	70364	985 872-0896	EP
Southern Fastening Systems	6245 West Main St.	Houma	70360	985 868-9685	EPC
Builders Tools and Fasteners	4947 Johnston St.	Lafayette	70503	337 981-8759	EPC
Bird Fasteners	68446 Tammany Trace Dr Ste. 2	Mandeville	70471	985 898-5885	PC
R. J. Marchand	3515 Division St	Metairie	70002	504 888-2922	EPC
Southern Fastening Systems	140 Laitram Lane	New Orleans	70123	504 734-0334	EPC
Southern Fastening Systems	751 Professional Dr. N	Shreveport	71105	318 798-3545	PC
Fastening Solutions, Inc	953 Louisiana Ave	Shreveport	71101	318 222-2212	P
Southern Fastening Systems	1439 Natchitoches	W. Monroe	71292	318 651-7530	PC
Tool Town LLC	704 N 7th St	West Monroe	71291	318 329-2929	EPC

## MAINE

Hogan Tire	135 Bangor St.	Houlton	04730	207 532-2211	EPC
Motor Power, Inc	P O Box 2066 1505 Lisbon St	Lewiston	04240	207 782-7017	EC
Emery Waterhouse	7 Rand Rd. P O Box 659	Portland	04104	207 775-2371	P
Applicators Sales & Service	400 Warren Ave. P O Box 10109	Portland	04104	207 797-7950	PC
Eldredge Lumber & Hardware	627 US Route 1	York	03909	207 363-2004	EPC

## MARYLAND

W T S INC	4000 Coolidge Avenue	Arbutus	21229	443 543-1000	EPC
Steel & Wire Products Co Inc	1501 W Patapsco Avenue	Baltimore	21230	410 355-2800	P
Capital Rentals	6401 Ammendale Rd.	Beltsville	20705	301 931-1445	EPO
Grabber	850B Hampton Park Blvd	Capital Heights	20743	301 808-5100	P
Bayco, Inc.	29448 Dover Road	Easton	21601	410 822-7722	PC
Mid Atlantic Fasteners	Emmorton Business Park	Edgewood	21040	410 671-7123	P
	2109 Emmorton Park Rd. Suite 117				
Mid Atlantic Fasteners	95 Monocacy Blvd Unit B4	Frederick	21701	301 293-6162	P
Grabber Virginia	5431 Yukon Ct, Ste G	Frederick	21703	301 371-0701	EP
Standard Supply	14 Chestnut St	Gaithersburg	20877	301 590-1752	EPC
Waters Appliance	216 E. Diamond Ave	Gaithersburg	20877-3014	301 258-7500	EPC
N & S Rentals	19600 Frederick Rd	Germantown	20876	301 428-3200	P
Mid Atlantic Fasteners	8220 Stayton Dr	Jessup	20794	410 505-9200	P
Altaquip	8280 Patuxent Range Rd Suite F	Jessup	20794	301 317-9854	EPCO
Mid Atlantic Fasteners	3695 Hallowing Point Rd Ste 2 Rte 231	Prince Fredrick	20678-3469	301 855-9690	P
Mid Atlantic Fasteners	2231 Northwood Drive	Salisbury	21801	410 860-2000	P
Marco Supply	2030 Shipley Dr , Suite 8	Salisbury	21801	410 546-3581	EP
Hemp's Power Tool Repair	13407 Gracehan Rd P O Box 335	Thurmont	21788	301 898-9916	EPCO
Diamond Tool Co	8051 Penn Randall Place	Upper Marlboro	20772	301 967-2844	EPC
Tool Solutions LLC	11822 Pika Dr	Waldorf	20602	301 396-3989	EPCO
Swain Portable Power Tool Repair	1280 Landing Lane	Westminster	21157	410 751-6802	EPC
Advanced Contractors Supply LLC	359 Manchester Rd	Westminster	21157	800 625-4700	EPC

## MASSACHUSETTS

Colony Hardware Supply	305 Freeport St	Boston	02122	617 287-2000	E
Isam Mitchell Co	362 Montello St	Brockton	02301	508 586-1271	EPC
J-K Tool & Fastener	568 Montello St Suite C	Brockton	02301	508 345-3308	EPC
Black Bear Tool & Supply	230 Turnpike St	Canton	02021	781 828-7895	EPC
Hingham Lumber Co.	165 Chief Justice Cushing Hwy	Cohasset	02025	781 749-4200	EPC
Panda Electrical Service	165 Main St	Everett	02149-5792	617 389-1442	EPC
Burns Power Tools	350 Mariano S Bishop Blvd	Fall River	02721	508 675-0381	EPC
Foxboro Tool Repair	16 Railroad Ave	Foxboro	02035	508 543-2606	EPC
Marathon Tool & Ind Supply Inc	1376 West Central Ave Unit 30	Franklin	02038	508 541-8665	EPCO
J & B Equipment Co.	456 Columbia Rd.	Hanover	02339	781 826-5931	EPCO
Behning Tool Co. Inc	785 Washington ST	Hanover	02339	781 826-4767	EPC
Reliance Electric	573 South Canal St	Holyoke	01040	413 533-3557	E
Northeast Tool Supply Corp.	157 Thornton Dr.	Hyannis	02601	508 778-4552	EPC
Adams Tool & Nail, Inc.	765 North Main Street Rt. 12	Leominster	01453	978 537-1582	PC
Cason's Equipment	937 Gorham Street	Lowell	01852	978 459-6852	PCO
Patriot Supply	172 Copeland Dr	Mansfield	02048	508 339-1900	EPC
National Lumber	245 Oakland St.	Mansfield	02048	508 339-8020	EPC
Palmac Co.	72 South Ave. P O Box 277	Natick	01760	508 655-0407	P
Tool Hauz	57 Crawford St	Needham Heights	02494	781 455-0555	EPC
National Lumber	15 Needham Street	Newton Highlands	02461	617 244-8020	EPC
Renner Colony LLC	5 Robert J Way	Plymouth	02360	508 746-2219	EPC

E= Electric P= Pneumatic C= Compressor O= Outdoor Power Equipment

## MASSACHUSETTS (cont.)

National Lumber	33 Mason Street	Salem	01970	508 744-8800	EPC
Saw Center Inc, The	472 Main St	Springfield	01105	413 734-2045	EPC
Industrial Tool Repair Co.	382 Middlesex Ave.	Wilmington	01887	800 897-8714	EPC
Altaquip	326 Ballardvale St.	Wilmington	01887	978 988-1313	EPCO
Star Sales & Distributing Corp.	29 Commerce Way	Woburn	01801	781 933-8830	EPC

## MICHIGAN

Electric Tool & Equipment	509 State Circle Suite 1	Ann Arbor	48108	734 995-1111	EPC
Glenn Wing Power Tool	33656 Woodward Ave.	Birmingham	48009	248 644-0444	EPC
Straight Drive Fasteners	5224 West River Dr	Comstock Park	49321	616 785-7977	EPCO
Re-Nu Electric Co	20163 John R Road	Detroit	48203	313 366-1570	EPCO
All Tool Repair	7225 Stanke Dr	East Lansing	48823	517 339-8011	EPC
Easy Handling Co. Inc	6180 Taylor Dr.	Flint	48507	810 239-8633	EPCO
Jones Equipment Rental	4600 24th Ave	Fort Gratoit	48059	810 385-6000	EPCO
Shannon Supply	8554 Carter Rd Suite #3	Freeland	48623	989 695-5573	EPCO
Cummins Bridgeway	977 N Center St	Gaylord	49735	989 732-5055	EPC
Fasteners, Inc.	2909 Buchanan SW	Grand Rapids	49508	616 241-3448	P
Hoeksema Tool Service, Inc.	2499 28th St SW	Grand Rapids	49519	616 538-1870	EPC
Fasteners, Inc.	11363 E. Lakewood Blvd	Holland	49424	616 394 4389	P
R & A Tool	5959 Sterling Dr	Howell	48843	517 552-0070	EPCO
Kalamazoo Electric Motor Inc.	414 Mills St	Kalamazoo	49001	269 345-7802	E
Fasteners, Inc.	1211 Haco Dr	Lansing	48912	517 485 5858	P
Fasteners, Inc.	32713 Schoolcraft Rd	Livonia	48150	313 422 7390	P
Hahn Systems	32423 West Eight Mile Rd.	Livonia	48152	248 476-2115	PC
Marsh Power Tools	20579 Middlebelt Rd.	Livonia	48152	248 476-7744	EPC
Copenhaver Machine Repair	5909 First St.	Ludington	49431	231 845-1345	EPC
Fasteners, Inc.	1605 Progress Dr.	Madison Heights	48071	248 542-5400	P
Linc Systems	32381 Howard Ave.	Madison Heights	48071	248 733-9070	PC
Central Michigan Toll & Equipment	4884 E Pickard St, Suite C	Mt. Pleasant	48858	989 839-0141	EPCO
Fasteners, Inc.	4101 Brubaker Rd	Petoskey	49770	616 347 4994	P
Pontiac Shaver Shop, Inc.	61 W. Huron St.	Pontiac	48342	248 334-1411	EPC
Altaquip	9770 Harrison Rd Bldg 12	Romulus	48174	734 947-9825	EPCO
Fasteners, Inc.	6285 Bay Road Suite 12	Saginaw	48604	989 792 1575	P
Robinson's Saw Service	52211 Van Dyke Ave	Shelby Township	48316	586 731-7175	EPC
Cummins Bridgeway	863 South Airport	Traverse City	49686	231 947-5824	EPC
Fasteners, Inc.	2676 Cass Rd Unit B	Traverse City	49684	231 946 3158	P

## MINNESOTA

Electric Motor Bearing Service	1401 West 9th Street	Albert Lea	56007	507 377-0032	EPC
FHL Services	6551 Jansen Avenue N.E.	Albertville	55301	763 315-3700	EPCO
FHL Services	320 North Maple Avenue	Annandale	55302	320 260-5810	EPC
Acme Tools	2025 30th St NW	Bemidji	56601	218 444-8665	EPC
Thomas Tool	3401 West Highway 13	Burnsville	55337	952 895-5613	EPC
Air King Fastening Systems, Inc.	3537 88th Ave NE	Circle Pines	55014	763 792-8940	PC
Thomas Tool	4901 West Broadway	Crystal	55429	763 533-2499	EPC
Diamond Drilling & Supply, Inc.	2916 West First St.	Duluth	55806	218 628-3671	EPC
Acme Tools	4332 Grand Ave	Duluth	55807	218 628-3523	EPC
Carlson Systems	1279 Trapp Rd. Suite 190.	Eagan	55121	651 688-0077	EPC
Packaging Inc	6775 Shady Oak Rd	Eden Prairie	55344	952 935-3421	EPC
Polar Tool & Supply	3642 Scheuneman Rd	Gem Lake	55110	651 653-1838	EPC
Nails, Etc.	1980 Quasar Avenue	Lake St. Croix Beach	55043	651 998-0480	EPC
Fastener Express, Inc.	8960 W 205th St P O Box 662	Lakeville	55044	952 469-2943	PC
Anchor Distributing Inc	2522 Northland Dr	Mendota Heights	55120	651 225-8480	PC
Deko Factory Service	3048 Bloomington Ave	Minneapolis	55407	612 721-6651	EPC
Acme Tools	4150 Berkshire Lane	Plymouth	55446	763 559-8665	EPCO
Thomas Tool	945 37th Ave. NW	Rochester	55901-6645	507 281-3786	EPC
Thomas Tool	300 14th Ave E	Sartell	56377	320 253-4526	EPC
Mathew Hall Lumber Co, Inc	127 6th Ave N P.O. BOX 128	St Cloud	56301	320 252-1920	EPC
Seven Corners Hardware Inc	216 W. 7th St.	St Paul	55102	651 224-4859	EPC
Altaquip	149 E Thompson Ave Suite 110	St Paul	55118	651 451-0821	EPCO
Carlson Systems	525 Apollo Ave NE Suite 4	St. Cloud	56304	320 259-0243	EPC
Reed Sales and Service	1260 Payne Ave.	St. Paul	55130	651 774-9515	EPCO
Top Line Tools & Fasteners	2623 Norway Pine Drive	St. Paul	55110	651 755-3006	PC
Thomas Tool	2987 West Highway 12	Wilmar	56201	320 231-1009	EPC
Fastenal	4730 North Service Dr.	Winona	55987	507 453-8289	EPC
Lackore Electric Motor Repair, LLC	108 West Second Street P. O. Box 407	Winona	55987	507 452-3103	EPC

E= Electric P= Pneumatic C= Compressor O= Outdoor Power Equipment

## MISSISSIPPI

Fastening Solutions, Inc	810 True Temper Drive	P O Box 396	Amory	38821	662 256-2223	P
Southern Fastening Systems	5310 Hwy 25 Suite 7		Flowood	39232	601 992-3737	PC
Southern Fastening Systems	2294 Nail Rd		Horn Lake	38637	662 342-7211	PC
May & Company Inc	838 W Capitol St		Jackson	39203	601 354-5781	EC
All Fast Inc	8690 Hacks Cross Road		Olive Branch	38654	662 895-9300	EPC
Fastening Solutions, Inc	6360 Cole Rd		Ridgeland	39157	601 977-9779	P
Southern Fastening Systems	814 President		Tupelo	38801	662 841-0349	PC

## MISSOURI

C S Sales and Service	16004 Gracey Creek Rd.		Barnett	65011	573 378-5930	EPC
TOOL BARN LLC	19343 HIGHWAY C		BARNETT	65011	873 378-6612	EPC
Clark's Tool	817 West 40 Hwy		Blue Springs	64015	816 228-9885	EP
Bowling Electric	20 Mulberry Lane	P O Box 199	Camdenton	65020	573 346-7553	EPC
Construction Tool Repair	806 Pannell St Unit C		Columbia	65201	573 499-1808	EPC
Mid-State Pneumatics LLC	303 S Franklin		Cuba	65453	573 885-9555	P
R.V. Evans of Decatur IL	13658 Lakefront Dr		Earth City	63045	217 412-3631	PC
Nu-Way Concrete Forms	4788 Old Cape Rd. E		Jackson	63755	573 204-0100	PC
Nu Way Concrete Forms, Inc	3100 South 10 Mile Dr.		Jefferson City	65109	314 893-8786	PC
C I S C O	2401 Summit		Kansas City	64108	816 842-7777	EPC
Carlson Systems	1691 N Topping Ave		Kansas City	64120	816 241-6735	EPC
Cisco	1807 Macon Ave		Kansas City	64118	816 421 0076	EPCO
White Cap	1907 Warren St		Kansas City	64116	816 471-1188	EPC
Heath Sales & Service	518 East 16th St		Kansas City	64108	816 421-3330	EPC
Midwest Hardware Rental	175 SE. 1st Lane		Lamar	64759	417 682-5951	EPCO
D-Low Repairs LLC	115 Church St		O'Fallon	63366	636 978-7513	EPCO
Construction Supply Co.	1044 Liberty Industrial Dr.		O'Fallon	63366	636 379-2100	EPCO
White Cap	423 N Belcrest		Springfield	65802	417 831-0954	EPC
Team Tools	4560 S. Campbell Avenue		Springfield	65810	417 881-8326	EPC
Tool Service Center	2431 Raymond Dr		St Charles	63301	636 940-2525	EPCO
Nu Way	4190 Hoffmeister Ave.		St Louis	63125	314 544-1214	PC
A R T Concrete & Tool Supply Co., Inc.	1743 Scherer Parkway		St. Charles	63303	636 940-0001	EPC
Duo-Fast Midwest	1595 Ashby Rd.	P O Box 21587	St. Louis	63132	314 426-5440	EP
Altaquip	1067 North Warson Road		St. Louis	63132	314 989-9026	EPCO
Nu-Way Concrete Forms	115 Resource Drive		Wentzville	63385	636 698-1001	PC

## MONTANA

Allen's Tool Repair	115 5TH Street West		Billings	59101	406 248-3865	EPC
Construction Fasteners & Supply, Inc.	350 Billings Blvd, Bldg 2B2		Billings	59101	406 256-3602	EPCO
Western Tool Supply	3088 Gabel Rd		Billings	59102	406 652-4797	P
Ace/Owenhouse Hardware #641Y	36 E Main Street		Bozeman	59715	406 587-5401	EP
Four Corners Hardware	177 Garden Dr		Bozeman	59718	406 586-4422	EP
Western Tool Supply	456 Pronghorn Trail		Bozeman	59718	406 556 9988	P
Big Sky Power Equipment	1439 NW By Pass		Great Falls	59404	406 761-6688	EPC
First Choice Repair & Sharpening	55 West Reserve Dr		Kalispell	59901	406 257-3946	EPCO
Hellgate Tool Repair	2006 North Ave.		Missoula	59801	406 549-3067	EPC
Western Tool Supply	2825 Stockyard Rd Unit D-1		Missoula	59808	406 728 2790	P
Northwest Tool Supply	1000 Baker Ave		Whitefish	59937	406 862-6275	EPC

## NEBRASKA

Carlson Systems	3203 Frontage Road		Grand Island	68803	308 384-1829	EPC
Carlson Systems	7003 S. 109th St.		La Vista	68128	402 951-5999	EPC
Carlson Systems	3107 S. 6th St. Suite 101		Lincoln	68502	402 423-2537	EPC
White Cap	1720 Adams Street		Lincoln	68521	402 435-2996	EPC
Carlson Systems	10840 Harney St		Omaha	68154	402 593-5310	EPC
Thacker Electric	8517 I St		Omaha	68127	402 592-9433	EPC
White Cap	9950 S 134th St		Omaha	68138	402 592-1250	EPC
Tighton Fasteners & Supply Inc.	7820 L St.		Omaha	68127	402 331-5550	EPCO
Builders Supply Company	5701 S 72nd Street	P O Box 27109	Omaha	68127	402 331-9030	PC
Powerhouse Distributing	11011 I St		Omaha	68137	402 715-5999	EPCO

## NEVADA

Silver State Roofing Materials, Inc.	1434 Industrial Way		Gardnerville	89410	775 782-7663	EPCO
Tool Service Inc	2912 S Highland Suite C		Las Vegas	89109	702 734-9161	EPCO
Fastening Systems Inc	3401 Sirius Ave #21		Las Vegas	89102	702 251-5474	EPC
Copper State Bolt & Nut	5530S Valley View Blvd Suite 106		Las Vegas	89118	702 597-5309	EPC

E= Electric P= Pneumatic C= Compressor O= Outdoor Power Equipment

## NEVADA (cont.)

FSP Unlimited	4731 Post #120	N Las Vegas	89118	702 795-7278	EPC
Apex Saw Works	570 Kietzke Ln	Reno	89502	775 329-3076	EPC
Titan Construction Supply	250 Edison Way	Reno	89502	775 351-2201	EPCO
Don Hoban Co.	1095 Spice Island #109	Sparks	89434	775 358-5644	EP
Industrial Equipment Repair Inc.	310 Kresge Lane	Sparks	89431	775 331-1032	E
White Cap Industries	1830 E Lincoln Way	Sparks	89434	775 353-3333	EPC

## NEW HAMPSHIRE

Brentwood Machinery & Tools, Inc.	313 State Route 125	Brentwood	03833	603 679-8452	EPC
Mountain View Tool Repair LLC	330 Route 125	Brentwood	03833	603 679-2023	EPC
Minuteman Tool Repair Inc	96 Epping Road Rt 27 P O Box 1802	Exeter	03833	603 778-7776	EPC
Manchester Tool Repair	722-3 E Industrial Park Dr.	Manchester	03109	603 622-0207	EPC
Bill's Rapid Gun Repair	129 Newton Rd Unite 4 Route 108	Plaistow	03865	603 382-7313	PC
New England Tool & Equipment	291 S Broadway	Salem	03079	603 898-6646	EP

## NEW JERSEY

Wally's Tool Repair	12 Texas Rd.	Aberdeen	07747	732 614-8563	PC
E Z Equipment, Inc	225 Chambers Bridge Rd.	Brick	08723	732 477-7483	EPC
Champion Fastening Systems, Inc.	1317 Doughty Rd	Egg Harbor Township	08234	609 484-1744	PC
Riverdale Tool Co	16 Midland Ave.	Elmwood Park	07407	201 791-6112	EPC
Bergen County Motor & Tool Co., Inc.	17-16 River Rd	Fair Lawn	07410	201 796-3006	EPCO
Closure Systems Inc	277 Lodi St	Hackensack	07601	201 646 1655	PC
Atlantic Tool Systems	170 Fifth Ave.	Hawthorne	07506	973 238-0009	E
Gams Power Tools & Supplies Inc.	133-135 Schuyler Ave.	Kearny	07032	201 955-0222	EPC
Hunterdon Mill & Mach Sup	289 RT 22 E	Lebanon	08833	908 534-2221	EPC
Cougar Electronics & Tool Repair	622 Broadway	Long Branch	07740	732 870-3302	EPCO
Power Tool Co	609 Memorial Dr	Neptune	07753	732 776-8282	EPC
Liberty Power Tool Repairs	600 Whitey Horse Pike	Oaklyn	08107	856 854-4384	EPCO
Altaquip	8550A Remington Ave	Pennsauken	08110	856 661-1800	EPCO
Shore Fasteners	500 N Main St.	Pleasantville	08232	609 646-6245	EPC
Metropolitan Staple	11 Brown Ave.	Springfield	07081	973 564-9500	EPC
Blair's Rental Service Inc.	1782 Hooper Avenue	Toms River	08753	732 255-3584	EPO

## NEW MEXICO

Tool Store, Inc. The	2419 D N White Sands Blvd	Alamogordo	88310	575 437-3131	EPCO
Telco Electric Inc	2906 4th Street N W	Albuquerque	87107	505 345-2426	EPC
Carlson Systems	8700 Alameda Blvd NE Suite 100	Albuquerque	87113	505 857-0045	EPC
West Albuquerque Winnelson Co.	4525 Anaheim Ave. NE	Albuquerque	87113	505 823-2625	EPC
White Cap	6707A Washington St NE	Albuquerque	87109	505 872-2244	EPC
Copper State Bolt & Nut Co.	8401 Washington NE	Albuquerque	87113	505 797-3100	EPC
Power Tool & Saw Service	2800 Richmond Drive N.E.	Albuquerque	87107	505 856-2158	EPCO
Honest D's Service and Repair	1907 4th Street NW	Albuquerque	87102	505 344-2571	EPC
KSP Power Tool	6 Wheeler Peak Rd	El Prado	87529	575 737-5775	EPC
Carlson Systems	400 C Compress Rd Suite L	Los Cruces	88005-2772	505 525-6738	EPC

## NEW YORK

Philipps Brothers Supply Inc	2525 Kensington Ave	Amherst	14226	716 839-4800	EPC
Dynamite Tool Co	1551 Smithtown Ave	Bohemia	11716	631 563-8181	EPC
Five Boro Pneu-Tronics Inc	801 E 42nd St	Brooklyn	11210	718 338-8911	EPCO
J & A Repair Shop	6206 20th Ave.	Brooklyn	11204	718 232-5746	EPC
White Tool Supply, Inc	3047 Atlantic Ave	Brooklyn	11208	718 277-8844	EPCO
Kinequip Inc.	365 Old Niagara Falls Blvd.	Buffalo	14228	716 694-5000	PC
Mohawk Ltd	1 Newell Lane P O Box 340	Chadwicks	13319	315 737-7328	EPCO
Air Compressor Plus	2419 Route 66	Chatham	12037	518 392-4080	EPCO
Eldred Power & Auto	550 Route 55	Eldred	12732	845 557-6168	EPCO
Guns & Hoses	1075 Dix Ave.	Hudson Falls	12839	518 747-8200	P
A & T Tool & Equipment	515 E Jericho Turnpike	Huntington Station	11746	631 271-2141	EPCO
Reliable Tool Service	491 Main St.	Islip	11751	631 581-8180	EPC
RAF Supply Inc	2350 Hamburg Turnpike	Lackawanna	14218	716 828-1322	EPC
Tool Ranch	3857 Walden Ave	Lancaster	14086	716 685-1556	EP
Universal Tool Sales & Service Corp.	1175 Montauk Hwy.	Mastic	11950	631 281-4147	EPC
Forestiere Power Tool & Equip	62-02 64th St	Middle Village	11379	718 416-0378	EPCO
On Time Supply	14 Melnick Dr	Monsey	10952	845 352-8600	EP
T P Rental Services	417 W 50th St	New York	10019	212 713-1999	EP
Precision Tool Repair	82 Colden St	Newburgh	12550	845 562-5045	EPC

E= Electric P= Pneumatic C= Compressor O= Outdoor Power Equipment



## NEW YORK (cont.)

Stapleco	7172 Ellicott Rd.	Orchard Park	14127	716 662-3728	EPC
Empire Tools LLC	21 Abendroth Ave	Port Chester	10573	914 937-1773	EPC
Harmco Fastener Co Inc	428 State St.	Rochester	14608	585 546-1650	EPC
Jackson Welding Supply	535 Buffalo Road	Rochester	14611	585 235-2920	E
J. Kozel & Sons/Tool Ranch	1150 Scottsville Rd	Rochester	14624	585 436-9807	EP
Kinequip, Inc.	300 White Spruce Blvd. Lower	Rochester	14623	585 272-1590	PC
Wainwright Repair Services	30 Berman Park	Rochester	14624	585 247-4079	EPCO
Altaquip	200 13th Ave Unit 6	Ronkonkoma	11779	631 580-4740	EPCO
Stewart Electric Repair Co.	412 Broadway	Schenectady	12305	518 393-5837	EPC
One Source Tool Supply	341 Country Rd 39A Suite 1	Southampton	11968	631 283-8700	EPC
H & E Tool Rental Corp.	6451 Amboy Rd.	Staten Island	10309	718 948-0505	EPC
Ramsing Electric Repairs Inc	914 Emerson Ave	Syracuse	13204	315 468-1712	E
Kinequip, Inc.	7340 Thompson Road North	Syracuse	13212	315 458-4115	PC
Ace Tool Repair	2201 Wantagh	Wantagh	11793	516 783-8899	EPC
B C Electric & Air	885 RT 376	Wappinger Falls	12590	845 227-8289	EPCO
Polidoro Enterprises Corp	124 Sunrise Highway	West Islip	11795	631 661-5548	EPC

## NORTH CAROLINA

B & K Tools	268 Biltmore Ave	Asheville	28801	828 254-5763	EPCO
Fastco of Charlotte	5201B Nations Ford Rd	Charlotte	28217	704 525-6401	EP
Diversified Equipment	11223 Blair Rd	Charlotte	28227	704 545-5198	EPC
Marco Supply	3837 Corporation Circle	Charlotte	28216	704 940 0158	EP
Little Hardware Co, Inc.	1400 South Mint St.	Charlotte	28203	704 333-3133	E
Rhino Assembly Corp	5900 Harris Tech Blvd, Ste T	Charlotte	28269	704 395-2100	EP
Altaquip	4112 Joe St	Charlotte	28206	704 509-4744	EPCO
Hudson's Hardware	77 Amelia Church Rd.	Clayton	27520	919 553-3030	PC
Payne's Tool & Supply	5010 Hwy 55	Durham	27713	919 544-9134	EPCO
Mid Atlantic Fasteners	901G Norwalk St.	Greensboro	27407	336 294-9776	P
Carolina Tool Repair & Sales	807 Huffman St.	Greensboro	27405	336 275-6124	EPC
Piranha Nail and Staple , Inc.	128-B Edwardia Drive	Greensboro	27409	336 852-8358	P
Dapco Ltd	2512 Asheville Hwy	Hendersonville	28791	828 693-8567	EPC
Piedmont Electric Repair	208 N Lindsay Street	High Point	27262	336 889-0222	E
Excel Fasteners	1208 Corporation Dr.	High Point	27263-1649	336 861-5543	P
Fastenal	4110 Premier Drive	High Point	27265	336 841-6555	EPC
Atlantic Coast Power Equipment	P O Box 205 1209 Bay Valley Rd.	Kenly	27542	919 284-0010	CO
Southern Fastening Systems	4801 Starcrest Dr.	Monroe	28110	704 238-0320	EPC
Carolina Megatools	605N Polk St.	Pineville	28134	704 889-8665	PC
Performance Fasteners LLC	P.O Box 146	Powells point	27966	252 261-9728	EPC
Chris Supply Co.	1640 S Sanders St	Raleigh	27603	919 833-4499	EPC
Southern Fastening Systems	3125 Gresham Lake Rd.	Raleigh	27615	919 862-0084	EPC
Southern Fastening Systems	9400-11 Ransdell Rd	Raleigh	27603	919 557-5950	EPC
J & S Tool Repair	1309 Hodges Street	Raleigh	27604	919 856-0050	EPC
BRM Nails & Tools, Inc.	2410 Sides Rd. P. O. Box 806	Rockwell	28138	704 279-8888	P
Glasson Tool & Supply Co.	1062 Hickory House Rd.	Sanford	27332	919 775-7715	EPC
Coastal Tool Repair	2079 Hwy 172 P O Box 943	Sneads Ferry	28460	910 381-6672	EPCO
McDonald Brothers	2401 US #1 North	Southern Pines	28388	910 692-2715	EPC
Bayco	631 Harbor Drive	Wanchese	27981	252 473-4997	PC
American Tool Repair LLC	102 Eastwood Rd Suite B-4	Wilmington	28403	910 392-5355	EPC
Piedmont Power Mach Service	4994C Indiana Ave	Winston Salem	27106	336 759-2022	EPC
Fastenal	8157 North Point Blvd.	Winston-Salem	27105	336 767-1176	EPC

## NORTH DAKOTA

H & L Sharpening Service	1032 Airport Rd	Bismarck	58504	701 223-9184	EP
Acme Tools	3840 East Rosser Ave	Bismarck	58501	701 258-1267	EPC
Dakota Fastening	3401 1/2 Interstate Blvd	Fargo	58103	701 298-3691	EPC
Acme Tools	920 36th St. SW	Fargo	58102	701 476-4600	EPC
Acme Tools	1705 13th Ave. North	Grand Forks	58203	701 746-6481	EPCO
Acme Tools	700 20TH Ave. SE	Minot	58701	701 839-2263	EPC

## OHIO

Fastenal	2465 Romig Rd	Akron	44320	330 745-2996	EPC
Authorized Tool Service	2210 Heller Dr	Beavercreek	45434	937 429-5593	EPC
Keim Lumber	4465 State Route 557	Charm	44617	330 893-2251	EPC
Fry Fastening Systems	2150 Waycross Rd	Cincinnati	45240	513 851-2233	EPC
Pro Tool	1125 Glendale-Milford Rd	Cincinnati	45215	513 772-1490	EPCO
Cincinnati Electric Repair	2023 Elm Street	Cincinnati	45202	513 621-2183	EPC

E= Electric P= Pneumatic C= Compressor O= Outdoor Power Equipment

Service

## OHIO (cont.)

Air Industrial Sales	8020 Beechmont Ave	Cincinnati	45255	513 231-2200	EPCO
Altaquip	11135 Ashburn Rd	Cincinnati	45240	513 674-6464	EPCO
Kay-Dee Air & Electric Tool Repair	5466 Lake Ct	Cleveland	44114	216 881-2565	EPCO
Tri County Power Tool	4597 Pearl Rd	Cleveland	44109	216 398-6120	EPCO
Capital Tool & Fasteners	9009 Gemini Parkway	Columbus	43240-2010	614 846-3443	EPC
Tradesman Tool Service	127 N Central Ave	Columbus	43222	614 274-4357	E
Wood Werks Supply, Inc.	1181 Claycraft Rd.	Columbus	43230	614 575-2400	EPC
Fry Fastening Systems	1203 Commerce Center Dr	Franklin	45005	937 743 9466	EPC
One Stop Tool Rental	4182 Tonya Trail	Hamilton	45011	513 895-8665	EPCO
Hartville True Value Hardware	940 W Maple St	Hartsville	44632	419 867-3631	EPC
Power Tool Sales & Service	6713 Angola Rd	Holland	43528	419 868-8665	EPC
Jugenheimer Industrial	6863 Commerce Dr	Hubbard	44425	330 534-8171	PC
Sauer Tools Sales & Service	1164 Dornach Dr	Lancaster	431304274	740 277-7500	EPCO
JWB Supply Co. Inc	126 N Market St	Lisbon	44432	330 424-9211	EPC
Electric Tool & Equipment	3637 Briar Field Blvd.	Maumee	43537	419 867-7670	E
Byler Seed and Hardware	16496 Nash Rd	Middlefield	44062	440 548-5580	EPC
Byler Air Tools	8169 Girdle Rd	Middlefield	44062	440 693-4394	EPC
Yoder Service & Supply	P.O. Box 143	Mt. Eaton	44659	330 359-2300	EPC
Altaquip	12274 Mahoning Ave Suite 9	North Jackson	44451	330 538-9725	EPCO
M & D LTD	25405 Briadway Ave Unit 4	Oakwood Village	44146	440 914-1252	EPCO
One Stop Tool Rental	7971 B Cincinnati Dayton Rd	West Chester	45069	513 777-3393	EPCO
Tool Shop, The	38130 Airport Parkway #4	Willoughby	44094	440 946-9950	EPCO
D & E Equipment	161 Doan St	Wilmington	45177	937 382-3501	EP
Power Tool & Supply Co. Inc.	3699 Le Harps Rd	Youngstown	44515	330 792-1487	E

## OKLAHOMA

Professional Fasteners & Tool	P.O. Box 4770	Broken Arrow	74159	918 741-8027	PC
Southern Fastening System	2104 North Willow Ave. #A	Broken Arrow	74012	918 254-6070	PC
Dave's Tool Service & Supply	1307 State Rd 70E	Celera	74730	580 434-8188	EPC
Koetter Construction Supply	14900 Bristol Park Blvd, Suite A	Edmond	73013	405 936-9446	EPC
Koetter Construction Supply, Inc.	2756 Broce Dr.	Norman	73072	405 447-7273	EPC
Whitton Supply	P. O. Box 2017 1419 W. Reno	Oklahoma City	73106	405 236-5561	EP
Mid States Industrial Supply	511 E 83rd	Oklahoma City	73149	405 632-5571	EPC
Southern Fastening Systems	609 E. Memorial	Oklahoma City	73114	405 755-7456	PC
Edmond Tool Repair	13517 Railway Dr Suite A	Oklahoma City	73114	405 752-2655	EPCO
Carlson Systems	12626 East 60th St Suite 110	Tulsa	74146	918 250-2602	EPC
Auto Battery & Electric	1026 E 4th St	Tulsa	74120	918 584-5555	EPC
Koetter Construction Supply, Inc.	5666 S 122nd Ave #B-7	Tulsa	74146	918 459-8050	EPC
CMC Cherokee	5460 S Garnett Unit B	Tulsa	74146	918 641-2555	EC

## OREGON

Western Tool Supply	2141 Santiam Hwy	Albany	97321	541 967-4222	P
Valley Equipment Rentals	2915 Highway 66	Ashland	97520	541 488-0716	EPCO
Oregon Tool & Equipment	1110 SE Reed Market Rd Unit B	Bend	97702	541 382-2435	EPC
Trade N Tools	61406 S Hwy 97	Bend	97702	541 382-0653	EPC
Western Tool Supply	420 Butler Market Rd.	Bend	97701	541 317-8383	P
Anco Fasteners	2130 W 6th Ave P O Box 2458	Eugene	97402	541 485-2800	EPC
Jims Tool Service	515 Wilson St	Eugene	97402	541 344-1243	EPC
Corcoran's Tool Repair	995 Tyinn Street # 6	Eugene	97402	541 485-9888	EPC
Eugene Power Tool, LLC	101 North Seneca	Eugene	97402	541 232-5081	EPC
Western Tool Supply	3225 S Sixth St.	Klamath Falls	97601	541 850-2830	
Western Tool Supply	2917 N. Pacific Highway	Medford	97501	541 776-1288	P
Cal-Ore Carbide	2919 N Pacific Hwy	Medford	97501	541 772-2293	EPC
Hudson Saw and Tool	2919 North Pacific Hwy.	Medford	97501	541 772-2293	EPC
Western Tool Supply	12518 NE Airport Way	Portland	97230	503 255 7331	P
O'Neill's Tools, Inc.	7133 NE Glisan	Portland	97213	503 254-6805	EPC
Chas. H. Day Co., Inc	602 S. E. 11th Ave.	Portland	97214	503 232-1659	EPC
Dave's Tool Repair	2392 S. Highway 97 #5	Redmond	97756	541 548-0510	EPC
Oregon Tool & Supply, Inc.	276 SE Stephens	Roseburg	97470	541 672-1935	EPC
Western Tool Supply	1820 NW Mullholland Dr	Roseburg	97470	541 957-2311	P
Western Tool Supply	2315 25th St SE	Salem	97302	503 566-4915	P
Eagle Fasteners Plus Inc.	1873 25th Street S.E.	Salem	97302	503 566-9240	EPC
Western Tool Supply	16700 SW 72nd Ave	Tigard	97224	503 684 5222	P

E= Electric P= Pneumatic C= Compressor O= Outdoor Power Equipment

## PENNSYLVANIA

Action Rental	4535 Broadway	Allentown	18104	610 395-3500	EPC
Closure Systems, Inc.	1327-D Adams Road	Bensalem	19020	215 245-1717	PC
Action Rental Center	1007 Marshall St.	Bethlehem	18017	610 395-0391	EPC
Home Warehouse	7 McKean Avenue P O Box 23	Charleroi	15022	724 483-8111	EPC
Hydraulic Industrial Supplies Co	300 E Madison Ave	Clifton Heights	19018	610 284-2100	EPC
Paul B. Moyer and Sons Inc.	190 S. Clinton St.	Doylestown	18901	215 348-1270	EPCO
Mid Atlantic Fasteners	1079 Commercial Dr	East Petersburg	17520	717 569-2431	P
Sensenig's Electronic Repair	215 Sensenig Rd.	Ephrata	17522	717 445-9905	E
Lake Erie Power Tools	3001 W 17th Street	Erie	16505	814 881-4303	EPC
Contactors Choice Equipment Rental, Inc	600 Lancaster Ave	Frazer	19355	610 408-0195	EPC
Gap Power Equipment	5399 Lincoln Hwy E	Gap	17527	717 442-8970	EP
Track & Tool LLC	99 Beach Lake HWY	Honesdale	18431	570 253-3892	EPC
A. R. Building & Materials	124 Rodgers Rd	Howard	16841	814 280-5058	EPCO
Fastenal	1225 Mid Valley Dr.	Jessup	18434	717 489-2772	EPC
U-Rent	1360 Franklin St.	Johnstown	15905	814 536-5404	EPC
Hartman Independent Co	93 Mayview Rd	Lawrence	15055	724 745-6566	EPC
B & C Fasteners Inc.	560 Industrial Dr.	Lewisberry	17339	717 938-6490	P
Power Tools & Supplies, LLC	2285 W Harrisburg Pike	Middletown	17057	717 944-1750	EPCO
Professional Tool Service	700 Seco Rd. Bldg 1	Monroeville	15146	412 373-7440	E
Keystone Air Power LLC	60 Elco Dr	Myerston	17067	717 866-9224	EPC
Byler Tools	9195 Sporting Hill Road	Orrstown	17244	717 477-8115	EP
Closure Systems	3450 East Lincoln Highway Unit 24	Paradise	17527	717 442-4240	P
Ideal Tool & Equipment	456 N. 8th St	Philadelphia	19123	215 925-0672	EPCO
Meyer's Co.	435 Davidson Rd.	Pittsburgh	15239	412 793-9100	P
Advantage Contractor Supply	39th & Butler Streets	Pittsburgh	15201	412 687-5005	EPC
ORE, INC.	699 North West End Blvd	Quakertown	18951	215 536-7874	EPC
G & S Fastening Systems Inc	110 Penn Am Drive	Quakertown	18951	215 538-2220	EP
Wm A Geppert, Inc	1561 Easton Road	Roslyn	19001	215 659-4215	EPC
Scranton Grinder and Hardware	1020 Hemlock St.	Scranton	18505	570 344-2520	EPCO
Stroudsburg Electric Motor Service	756 Phillips St.	Stroudsburg	18360	570 421-8909	EPC
G & S Fastening Systems	600 Front St	Whitehall	18052	610 264-7587	EP
Mid Atlantic Fasteners	1130 West Branch Hwy	Winfield	17889	570 524-7366	P
Wolfe Pneumatic Service, Inc.	440 Meridian Lane	York	17402	717 840-6865	EPCO

## RHODE ISLAND

Quaker Lane Tool Repair	3520 Quaker Lane P O Box 321	North Kingstown	02852	401 295-5472	EPC
Eastern Tool Repair Center LLC	421 Hartford Avenue	Providence	02909	401 621-9200	EPCO

## SOUTH CAROLINA

Trado Supplies Inc.	1015 Whitehall Dr	Anderson	29625	864 225-4438	EPC
Anchor Hardware	9 Kitties Landing Rd.	Bluffton	29910	843 815-9264	EPC
CARSONS NUT & BOLT CO INC	P O BOX 3629	GREENVILLE	29608	864 622-1080	EPCO
CARSONS NUT & BOLT CO INC	301 Hammett Street	Greenville	29609	864 242-4720	EPCO
Southern Fastening Systems	7120 Broad River Rd.	Irmo	29063	803 749-1552	P
Coastal Electric & Rewind Co Inc	928 Oceola Street	Myrtle Beach	29577	843 448-3586	EPC
Mid Atlantic Fasteners	3195-B Hwy 17 By-Pass S.	Myrtle Beach	29577	843 293-8795	P
Marco Supply	3537 Dorchester Rd	North Charleston	29405	843 747 5358	EP
CARSONS NUT & BOLT CO INC	522 Broadcast Blvd	Spartanburg	29303	864 585-9686	EPCO
Tool Box	1507 Asheville Hwy.	Spartanburg	29303	864 573-8547	C
Dixie Tools & Fasteners Inc	2765 Underwood Rd	Sumter	29154	803 481-2200	P
Mann Tool & Supply	802 Chris Drive	W. Columbia	29169	803 252-7777	EPC

## SOUTH DAKOTA

Stan Houston Equipment	1210 Deadwood Ave	Rapid City	57702	605 336-3727	EPCO
Stan Houston Equipment	501 So. Marion Rd.	Sioux Falls	57106	605 348-1155	EPC
Construction Products	101 E. Benson Rd	Sioux Falls	57104	605 332-4991	EPC
Carlson Systems	27079 Mueller Pl	Sioux Falls	57108	605 368-9022	EPC
Excel Tool Repair	1011 W. 41st St.	Sioux Falls	57105	605 336-0444	EPC

## TENNESSEE

Southern Fastening Systems	8024 Stage Hill Blvd. # 10	Bartlett	38133	901 372-1799	EPC
Duo-Fast of Knoxville	4009 Industry Dr	Chattanooga	37416	423 892-0626	P
Altaquip	1320 Appling St. Unit B	Chattanooga	37406	423 624-7161	EPCO
Dixie Industrial Service, Inc.	2108 E Main St	Chattanooga	37404-3645	423 698-8063	EC

E= Electric P= Pneumatic C= Compressor O= Outdoor Power Equipment

## TENNESSEE (cont.)

Champion Industries	455 Neville Rd.	Collierville	38017	901 854-6787	E
Southern Fastening Systems	1120 Lakeview Drive Suite 900	Franklin	37067	615 790-3423	PC
S & S Power Sports	208 E Old Andrew Johnson Highway	Jefferson City	37760	865 475-6294	EPCO
Duo-Fast of Knoxville	3 Charter Ct, Ste A	Johnson City	37604	423 610-1300	P
Duo-Fast of Knoxville	3906 Papermill Rd.	Knoxville	37909	865 588-2453	P
Southern Fastening Systems	5446 Hilton Industrial Way	Knoxville	37921	865 212-4155	PC
Brady Tool Service, Inc	2002 East Magnolia Ave	Knoxville	37917	865 546-7744	EPC
Southern Fastening Systems	1122 Stones River Court	Lavergne	37086	615 287-9565	PC
Commercial Tool Service	319 Oakley St	Livingston	38570	931 403-1810	EP
Authorized Equipment Service	812 Polk Avenue	Memphis	38126	901 774-0850	EPCO
Stapleco, Inc.	3785 E Andrew Johnson Hwy	Morristown	37814	423 586-8405	PCO
Allied Tool Repair	1005 2nd Ave S	Nashville	37210	615 242-8026	EPCO
Kentec Megatools	2177 Nolensville Pike Suite 101	Nashville	37211	615 255-8771	PC
Reeves Power Tools & Repair	108 Lafayette St. P. O Box 100525	Nashville	37210	615 256-8817	EPC
Duo-Fast of Knoxville	1811 Elm Hill Pike	Nashville	37210	615 889-1800	P
Southern Fastening Systems	5111 Nolensville Rd.	Nashville	37211	615 833-7178	PC
Power Tool Service, Inc.	1106 Elm Hill Pike Suite 130	Nashville	37210	615 255-8227	EPCO
Gillis Small Engine, Llc	1295 Florence Rd.	Savannah	38372	731 925-5900	EPCO

## TEXAS

Abilene Fastener Supply, Inc.	1641 So. Treadway	Abilene	79602	325 673-9200	EPC
Malcolm Supply	1833 South Treadaway Blvd	Abilene	79602	325 670-9066	E
JBS Tool & Fastener	705 N. Greenville #500	Allen	75002	972 727-8770	PC
Reid's Appliance Service	906 S. Georgia	Amarillo	79102	806 373-8812	EPC
Southern Fastening Systems	4525 Maverick St	Amarillo	79109	806 355-6510	PC
Texas Tool Traders	2215 East Division	Arlington	76011	817 640-9846	PC
Brannens Inc	2627 Buell Avenue	Austin	78757	512 458-4011	P
Texas Tool Traders	2101 West Ben White #102	Austin	78704	512 383-8386	P
Altaquip	3800 Drossett Dr Suite C & D	Austin	78744	512 428-4859	EPCO
Southern Fastening Systems	7400 College St	Beaumont	77707	409 842-6969	PC
Texas Tool Traders	152 Loy St	Burleson	76028	979 263 5015	EP
Air Fasteners, Inc	1610 N I-35 E #200	Carrollton	75006	972 245-2441	EPC
Southern Fastening Systems	2151 Harvey Mitchell Pkwy S #201	College Station	77840	979 693-8884	PC
Sprayberry Tool Co	2902 Cain Rd	College Station	77845	979 764-9650	EPC
Pate's Hardware	900 E Central	Comanche	76442	325 356-3177	EPC
Brannens Inc.	101 Amanda Street	Conroe	77304	936 756-5299	P
Southern Fastening Systems	113 B Rhodes Street	Conroe	77301	936 539-6300	PC
Otto Dukas Machinery Co.	2556 Agnes St	Corpus Christi	78405	361 883-0921	EPC
Southern Fastening Systems	4531 Ayers Street #303	Corpus Christi	78415	361 854-9672	PC
Air Nail Builders	1826 North Padre Island	Corpus Christi	78408	361 299-6245	EPC
Four Seasons	1830 Holly Rd	Corpus Christi	78417	361 814-9292	EPC
Southern Fastening Systems	15926 Cypress N Houston, Ste 50	Cypress	77410	281 213 9285	PC
Hurricane Tool & Supply	4330 Center St. P O Box 817	Deer Park	77536	281 476-5530	EPC
Fastenal	3833 Airport Rd	Denton	76207	972 245-8171	EPC
Southern Fastening Systems	3431 Gulf Freeway	Dickinson	77539	281 534 0480	P
Carlson Systems	1560 Lionel Dr Suite 100	El Paso	79936	915 593-1014	EPC
Copper State Bolt & Nut Co.	11129 Pellicano Dr	El Paso	79935	915 595-3111	EPC
Rio Industrial Supply Co.	3522 Frutas	El Paso	79905	915 533-0984	EP
Southern Fastening Systems	7716 Trinity Blvd.	Fort Worth	76118	817 284-1751	PC
White Cap	2037 E Lancaster	Fort Worth	76103	817 332-4117	EPC
Texas Tool Traders	2414 South Jupiter	Garland	75041	972 278-0049	PC
Southern Fastening Systems	421 West Interstate 30	Garland	75043	972 303-9555	PC
Brannens Inc.	2544 E. Shell Rd.	Georgetown	78628	512 930-1080	P
Almighty Rentals	2534 Shell Rd	Georgetown	78628	512 868-3788	EPC
Southern Fastening Systems	2985 Hwy 360 South #128	Grand Prairie	75052	972 602-7761	PC
Altaquip	923 Avenue N	Grand Prairie	75050	972 206-0079	EPCO
Tool Clinic, The	4100 Haltom Rd. Suite D	Haltom City	76117	817 656-5640	EPC
Acme Tool Repair	2205 Moneda St	Haltom City	76117	817 834-6666	EPC
Hillcountry Tool and Vacuums	12682 FM1560 Suite 106	Helotes	78023	210 372-9598	EPC
Empire Tool Traders	6327 W. 34th St.	Houston	77092	713 957-8665	EPCO
Power Tool Service	3718 Polk Avenue	Houston	77003	713 228-0100	E
Texas Tool Traders	5900 North Freeway	Houston	77076	713 697-9909	PC
Nationwide Dist Co Inc	6100 N Shepherd Drive	Houston	77091	713 697-6245	EPC
Texas Tool Traders	440 Highway 6 South	Houston	77079	281 496-0811	PC
Clark Supply Co	9433 Summerbell Ln	Houston	77074	713 771-0404	EPC
Southern Fastening Systems	3430 S Sam Houston Parkway East #200	Houston	77047	281 997-7474	PC

E= Electric P= Pneumatic C= Compressor O= Outdoor Power Equipment

## TEXAS (cont.)

Texas Tool Traders	10535 Wilcrest	Houston	77099	281 933-6300	PC
Southern Fastening Systems	6264 Hwy 6 South	Houston	77083	281 933-9116	PC
Southern Fastening Systems	7425 Pinemont Suite 300	Houston	77040	713 688-3781	PC
Metal Building Supply	2146 Bingle Rd	Houston	77055	713 688-2582	E
Tooltech	3406 McAshan	Houston	77003	713 229-8637	EPCO
Altaquip	10685 Hazelhurst Dr	Houston	77043	713 647-0736	EPCO
H & H Tool Service	2307 McAllister Rd	Houston	77092	713 682-8665	EP
Innovative Tooling & Acc.	13203 Emmett Road	Houston	77041	713 996-9909	E
Dickson Tool & Equipment	130 S. Nursery	Irving	75060	972 579-7774	EC
Air Supply & Fasteners	91 Coronado Dr	Kerrville	78028	830 896-3922	EPC
Southern Fastening Systems	1810 Junction Hwy #208	Kerrville	78028	830 896-3226	PC
Southern Fastening Systems	123 Flecha Lane	Laredo	78045	956 725-2601	P
Texas Tool Traders	120 Gulf Freeway	League City	77573	281 332-9201	PC
Texas Tool Traders	816 East Highway 121	Lewisville	75057	972 434-2999	PC
Southern Fastening Systems	701 S. Stemmons Freeway #108	Lewisville	75056	972 434-6245	PC
Southern Fastening Systems	542 Henderson Lane	Longview	75605	903 663-3597	PC
Tool Care	803 Cherokee St.	Longview	75604	903 295-9966	E
Caprock Equip. Service & Supply	2112 50TH	Lubbock	79412	806 747-9177	EPC
Southern Fastening Systems	5044 Frankford #400	Lubbock	79424	806 797-0135	PC
Southern Fastening Systems	4103 North Medford	Lufkin	75901	936 634-4804	PC
Nationwide Distributing	2517 W. Business 83	McAllen	78501	956 630-2600	PC
Southern Fastening Systems	817 E. Fir	McAllen	78501	956 682-0402	PC
Brannen's Inc	1673 US Hwy. 290 East	McDade	78650	512 273-2282	P
Texas Tool Traders	307 W University	McKinney	75069	972 562-1111	PC
Southern Fastening Systems	1308 South Midkiff Suite 101	Midland	79701	432 570-8909	PC
National Tool and Fastener	P.O. Box 631529	Nacogdoches	75963	936 462-9192	EPC
Builders Tools & Fasteners	713 E. 2nd Street	Odessa	79761	915 332-3511	EPC
Texas Tool Traders	16401 Central Commerce	Pflugerville	78660	512 989-0001	PC
Valley Outdoor Power Equipment	1012 E Ferguson Rd 495	Pharr	78577	956 787-0469	EPCO
American Industrial Supplies & Tool Repair	1101 A West Business 83	Pharr	78557	956 702-4410	EPCO
American Tool & Fastener	1331 E. Plano Parkway Suite B	Plano	75074	972 801-9909	EPCO
Southern Fastening Systems	3321 North IH-35 Suite 100	Round Rock	78664	512 248-9005	PC
Cross Texas Supply LLC	5294 Old Christoval Rd	San Angelo	76904	915 651-1408	E
Angelo Bolt & Industrial Supply	808 Warehouse Rd.	San Angelo	76903	325 655-0075	E
Southern Fastening Systems	922 Arroyo Drive	San Angelo	76903	325 944-8091	PC
Texas Tool Traders	4310 Naco Pass	San Antonio	78233	210 525-1418	PC
Brannen's Inc.	1835 Fredericksburg Rd.	San Antonio	78201	210 736-1625	P
Southern Fastening Systems	12075 Starcrest	San Antonio	78247	210 481-1313	PC
Electric Motors Service & Sales	1514 E. Commerce St.	San Antonio	78205	210 226-3462	EPC
JM Rental	924 Oblate Drive	San Antonio	78216	210 525-0643	EC
TECHLINE INC	4314 DIVIDEND DRIVE	SAN ANTONIO	78219	210 359-8324	O
Southern Fastening Systems	2920 S General Bruce Dr (IH35)	Temple	76504	254 774-8315	PC
Southern Fastening Systems	13154 Hiway 155 S Suite B	Tyler	75703	903 581-5454	PC
East Texas Staple	15989 FM 2493 Unit D	Tyler	75703	903 939-9000	EPC
Southern Fastening Systems	211 East Anaqua	Victoria	77901	361 578-7891	PC
Southern Fastening Systems	325A Cotton Drive	Waco	76712	254 772-6097	PC
Gross-Yowell	3720 Franklin Avenue	Waco	76710	254 754-5475	EPC
Ludwig Saw & Tool	1701 Maple Ave	Waco	76707	254 754-6951	EPC
Texas Tool Traders	6500 Denton Highway	Watauga	76148	817 577-0879	PC
Texas Tool Traders	13317 Seydler Rd.	Weimar	78962	979 263-5015	PC
Roquemore's Hardware	300 Hwy 110N P O Box 778	Whitehorse	75791	903 839-6606	EPC
Southern Fastening Systems	100 Galveston St	Wichita Falls	76301	940 322-8362	PC
Southern Fastening Systems	650 Sanden Blvd	Wylie	75098	972 202-5000	PC

## UTAH

Cedar Fastening Systems	473 N 200 W	Cedar City	84720	435 865-1577	EPC
Air O Fasteners	343 North 650 West	Kaysville	84037	801 547-1010	P
Glenn's Electric Inc	501 N Main	Logan	84321	435 752-4178	EPC
Timberline Woodworkers Supply	1402 W. Center Street	Orem	84057	801 224-2260	EPC
White Cap	555 South 1325 West	Orem	84058	801 765-0361	EPC
Mending Shed, The	1735 S.State St.	Orem	84097	801 225-8012	EPC
Summit Fasteners	1590 W. Center Street	Orem	84057	801 224-3881	EPCO
Consolidated Fasteners	3943 South 500 West	Salt Lake City	84123	801 261-0200	P
White Cap Industries	2503 So 300 West	Salt Lake City	84115	801 463-2770	P
Fastenal	1605 West 2100 South Unit A	Salt Lake City	84119	801 908-0286	EPC
M & M Tool & Machinery	3362 South Main St.	Salt Lake City	84115	801 485-8200	EPCO

E= Electric P= Pneumatic C= Compressor O= Outdoor Power Equipment

## UTAH (cont.)

Western Tool Supply	2855 S 280 West	Salt Lake City	84115	801 486-3100	P
A1 Industrial Tools & Service	546 W 9320S	Sandy	84070	866 802-6383	EPCO
White Cap	3884 S River Rd	St George	84790	435 627-2372	EPC
Dixie Fastening Systems	314N 3050E Suite C	St. George	84790	435 673-5337	EPC
Connectors for Construction LLC	2008 West 2550 South	West Haven	84401	801 627-8156	EPC

## VERMONT

Tool Warehouse Outlet, Inc	1519 US Route 302 - Berlin	Barre	05641	802 479-3363	EPCO
Vermont Tool Repair	935 Main St	Colchester	05446	802 879-2666	EPC
Burlington Tool Repair	3 Kellogg Rd	Essex	05452	802 872-0051	EPCO

## VIRGINIA

Valley Tool Repair	7689 Nazarene Church Rd.	Bridgewater	22812	540 828-3320	EPC
Grabber	14801 Williard St. Suite 700	Chantilly	20151	703 631-8770	EP
Mid Atlantic Fasteners	14919 Bogle Dr.	Chantilly	20151	703 222-3278	P
Marco Supply	4280-F Henninger Ct	Chantilly	20151	703 378 1125	EP
Tool Tech Service Group	4270 Henninger Ct Unit J	Chantilly	20151	703 870-7442	PC
Mid Atlantic Fasteners	450 Pantops Ctr	Charlottesville	22911	434 977-1890	P
Mid Atlantic Fasteners	920 A Cavalier Blvd.	Chesapeake	23323	757 485-7173	P
Master Tool	1226 Executive Blvd Unit 105	Chesapeake	23320	757 547-8665	EPC
Dublin Tool & Supply	101 Town Center Drive P.O. Box 2085	Dublin	24084	540 674-5784	EPC
Capital Rentals	12716 Lee Highway	Fairfax	22030	703 803-8585	EP
Mid Atlantic Fasteners	1319 Lafayette Blvd	Fredericksburg	22401	540 371-9206	P
GLS Tool Clinic	3075 Old 33 Rd.	Harrisonburg	22801	540 434-6151	E
Mid Atlantic Fasteners	4810 South Valley Pike	Harrisonburg	22801-3934	540 564-9656	P
Hawkins Graves	2210 Florida Ave	Lynchburg	24501	434 847-7703	EPC
Capital Rentals	10844 Balls Ford Rd.	Manassas	20109	703 368-6120	EP
Capital Rentals	11825 Livingston Road	Manassas	20109	703 368-6220	EP
Stronghold Supply, Inc.	12189 Balls Ford Road	Manassas	20109	703 257-5910	EPC
Temp-Power, Inc	12269 Livingston Rd	Manassas	20109	703 330-3663	EPC
Mid Atlantic Fasteners	14331 Sommerville Ct.	Midlothian	23113	804 794-7801	P
Mid Atlantic Fasteners	709 Middle Ground Blvd, Suite A105	Newport News	23606-4548	757 873-1349	P
Bryan Electric Co Inc	424 W 25th Street P. O Box 11085	Norfolk	23517	757 625-2525	EPC
Phillips Tool Repair, Inc	22950 Kings Highway	Randolph	23962	434 735-8229	EPC
Staley Co. (Arcet), The	1000 W. Roberts Street	Richmond	23220	804 321-6595	EPC
Marco Supply	1908 North Hamilton St.	Richmond	23230	804 358-3331	EP
Rent-All of Roanoke	604 11th St NW	Roanoke	24017	540 345-0184	EPC
Mid Atlantic Fasteners	7740 Garland Circle	Roanoke	24019	540 366-0199	P
Marco Supply Co.	812 Pocahontas Ave.	Roanoke	24022	540 344-6211	EP
Pro Power Tools & Equipment Repair	3002 Shenandoah Ave NW	Roanoke	24017	540 206-3726	EPCO
Capital Rentals	44232 Mercure Circle	Sterling	20166	703 661 8260	EP
Capital Rentals	22195 Shaw Rd.	Sterling	20166	703 444-0040	EP
Fastening Systems of VA	4676 Princess Anne Rd Suite 250 & 260	Virginia Beach	23462	757 495-9018	EPC
Mid Atlantic Fasteners	222 Admiral Byrd Blvd Unit G	Winchester	22602	540 662-7595	P
Lance's Tool Repair, Inc.	118 A Production Drive	Yorktown	23693	757 223-4180	PC

## WASHINGTON

Power Tool Service	12121 NE Northup Way #108	Bellevue	98005	425 453-8015	EPC
Eastside Staple & Nail, Inc	1917 120th Ave NE	Bellevue	98005	425 641-6191	P
Pro Tool, Inc	2238 James St	Bellingham	98225	360 733-7343	EPC
Northwest Tool Repair	1667 Old Hwy 99 N.	Bellingham	98229	360 676-8665	EPCO
Altaquip	103 McBride Ct	Chehalis	98532	360 748-8017	EPCO
Outback Nail & Staple Inc	1058 N.W. State St	Chehalis	98532	360 740-1775	EPC
Manor Hardware	2814 Rucker	Everett	98201	425 258-1466	EPC
Western Tool Supply	8613 South 212th St	Kent	98031	206 395 3102	P
Pacific Nail & Staple	11332 120th Ave. NE	Kirkland	98033	425 828-6694	EPCO
Western Tool Supply	1225 Ruddell Rd Suite G	Lacey	98503	360 413 1660	P
Fastenal	9725 47th Ave. Bldg. 20 Suite A P. O. Box 99130	Lakewood	98499	253 983-1561	EPC
Tap Tool Repair	10313 Lakeview Ave SW, Suite B	Lakewood	98499	253 441-2177	EPC
C & H Industrial Tool & Repair	1160 3rd Ave. P. O. Box 1807	Longview	98632	360 423-6496	EPC
Manor Hardware	21323 68th Ave. West	Lynnwood	98036	425 778-2841	EPCO
Cascade Fasteners, Inc	1105 Tenth St.	Marysville	98270	360 657-1225	PC
Milne Nail, Power Tool & Repair	1303 West Lewis St.	Pasco	99301	509 547-7834	EPC
DSC, Inc.	3203 Totten Rd. NE Unit F P O Box 2640	Poulsbo	98370	360 697-3280	P
Electrical Shop, Inc, The	19559-D Viking Way	Poulsbo	98370	360 697-4454	EPC
Tool Pros	10334 Lake City Way NE	Seattle	98125	206 525-6448	EP

E= Electric P= Pneumatic C= Compressor O= Outdoor Power Equipment

## WASHINGTON (cont.)

Sharp Shop	128 S. Lucile St.	Seattle	98108	206 762-6480	P
Spokane Power Tool & Hardware	801 E Spokane Falls Blvd	Spokane	99202	509 489-4202	EPC
Inland Fastening	1306 E. Trent	Spokane	99202	509 535-5770	P
Power Tool Service	1902 E. Mission	Spokane	99202	509 535-1754	EPCO
Western Tool Supply	4014 E Broadway	Spokane	99202	509 534 3866	P
Air Electric Tools & Service, Inc.	East 5603 3rd Ave	Spokane	99212	509 534-3698	EPC
Country Homes Supply	4111 E. Francis Avenue	Spokane	99217	509 467-6615	P
Center Electric Inc.	1212 S 30th Ave	Tacoma	98409	253 383-4416	E
Manor Hardware	11317 Steele St Ste 103	Tacoma	98444	253 581-7746	EPC
White Cap	3037 Center St	Tacoma	98409	253 779-4100	EPC
Coastal Nail & Staple	715 78th Ave SW Unit C	Tumwater	98501	360 956-1973	EPC
Western Tool Supply	1901 South 14th St	Union Gap	98903	509 574-4323	P
Vancouver Tool Repair	7613 NE St. John's Rd	Vancouver	98665	360 993-0091	EPCO
Tool Mart/Motor Mart	154 Marr	Wenatchee	98801	509 664-6606	EC
Western Tool Supply	13440 NE 177th Place	Woodinville	98072	206 488-7222	P
Inland Fastening Systems	302 S. First St	Yakima	98901	800 487-5770	P

## WEST VIRGINIA

Hughes Supply	300 Rural Acres Dr.	Beckley	25801	304 252-1918	EPC
Larry's Pneumatic Service	100 Princeton Ave	Bluefield	24701	304 325-9262	P
Home Warehouse	P.O. Box 448	Dellslow	26531	304 291-1006	P

## WISCONSIN

Northern Compressor LLC	4302 W. Edgewood Dr.	Appleton	54913	920 757-6304	EPC
Carlson Systems	3011 Mondovi Rd	Eau Claire	54701	715 835-4849	EPC
Bay Verte Machinery Dr Tool Service Ctr	975 Parkview Rd.	Green Bay	54304	920 336-7440	EPCO
Woodworker's Depot	2965 Ramada Way	Green Bay	54304	920 336-6900	EPC
Advanced Fastening Supply	W6357 Design Drive, Suite C	Greenville	54942	920 993 1089	EPC
Carlson Systems	224 Causeway Blvd Suite 4	LaCrosse	54603	608 782-2007	EPC
Lackore Electric Motor Repair, Inc.	4102 Mormon Coulee Ct.	LaCrosse	54601	608 782-7635	EPC
Brunsell Lumber	4611 W. Beltline Hwy.	Madison	53711	608 275-7171	EP
Advanced Fastening Supply	2201 Advance Rd	Madison	53718	608 441-1950	EPCO
Neu's Building Center	N95 W16915 Richfield Way	Menomonee Falls	53051	262 251-6550	EPCO
Bird Ladder & Equipment Co., Inc.	2620 South 5th Street	Milwaukee	53207	800 776-3595	EPC
Wisconsin Power Tools	3122 N Mayfair	Milwaukee	53222-3202	414 774-3650	E
West Shore Tool Service LLC	680 Maple St	Peshtigo	54157	715 582-0300	EPCO
Jensen Equipment Co., Inc.	N27 W23015 Roundy Drive	Pewaukee	53072	262 547-5548	ECO
U C I Sales Inc	2601 Douglas Avenue	Racine	53402	262 639-1225	EP
Carlson Systems	103 W Industrial Park Ave.	Rothschild	54474	715 359-3137	EPC
Thomas Industrial Supply, Inc.	748 Alderson St. P. O. Box 647	Schofield	54476	715 359-4124	P
Erickson's True Value Hardware	207 N Broadway	Stanley	54768	715 644-3375	EPC
Packaging Inc	N16 W23390 Stoneridge Dr , Ste B	Waukesha	53188	262 521 9688	EPC
Advanced Fastening Supply	21675 Doral Rd.	Waukesha	53186	262 798-3978	EPC
R W Herbert LLC	4896 Sunset View Dr.	West Bend	53095	262 644-8293	PC

## WYOMING

Builders Lumber & Supply Co.	1220 Meadowlark LN P. O. Box 7407	Jackson	83001	307 733-4165	EP
------------------------------	-----------------------------------	---------	-------	--------------	----

## I General Safety Precautions For Electric Tools

1. Read and understand instruction manual before operating the tool.
2. Keep work area clean and uncluttered.
3. Consider work area and environment. Keep work area well lit. Don't expose power tools to rain or wet locations. Don't use power tools in presence of flammable gases or liquids.
4. Keep visitors away from work area.
5. Store idle tools. When not in use, tools should be stored in a dry location.
6. Use correct tool. Use tool for intended purpose only.
7. Use safety glasses. Also use proper face or dust mask if cutting operation is dusty.
8. Don't wear loose clothing or jewelry when operating tool. Wear protective hair covering to contain long hair. Rubber gloves and non-skid footwear are recommended for working outdoors.
9. Never carry tool by cord or yank it to disconnect from receptacles. Keep cord away from oil, heat and sharp edges.
10. Secure work with clamps or a vise.
11. Don't over reach. Keep proper footing and balance at all times.
12. Maintain tools with care. Keep tools clean for better and safer performance. Follow instructions for lubricating and changing accessories.
13. Guard against electrical shock. Prevent body contact with grounded surfaces, such as: pipes, radiators, ranges, etc.
14. Unplug tools when not in use, before servicing, and when changing accessories, such as blades or bits.
15. Remove adjusting keys and wrenches before turning tool on.
16. Avoid unintentional starting. Be sure switch is OFF when plugging tool in.
17. Use only outdoor-use extension cords when operating tools outdoors.
18. Check damaged parts. Damaged parts should be properly repaired or replaced by an authorized service center.
19. Never leave tools running while unattended. Do not leave tool until it comes to a complete stop.
20. Use only Hitachi replacement parts when servicing.
21. Use recommended accessories only.
22. Stay alert when operating tool.

## II General Safety Precautions For Pneumatic Tools

1. Read and understand instruction manual before operating the tool.
  2. Protect yourself. When operating the tool, always wear safety eye protection and ensure that people nearby do so also. Wear proper clothing--neckties, gloves and open cuffs can be caught by a tool.
  3. Use only for proper applications and with fasteners designed for the tool. Exceeding the recommended usage for a tool can cause operational problems, and can only be dangerous. Also, use only approved fasteners--trying to make the wrong ones fit will only cause problems.
  4. Handle the tool correctly.
    - Use a correct stance and make sure your foot is secure.
    - Stop operation if something appears to be wrong.
    - Check the push lever and trigger: Without fasteners loaded, connect the hose and depress the push lever against test or scrap metal; if the sound of operation occurs, it indicates a fault and the tool should be inspected and repaired. Also, if merely pulling the trigger causes driver blade movement, there is a problem, and inspection and repair is indicated.

**WARNING** Keep your finger off the trigger except during fastening operation, because serious injury could result if the push lever accidentally contacts or others in work area.

**WARNING** Keep hands and body away from the discharge area. The nailers with contact trip mechanisms may bounce from the recoil of driving a fastener and an unwanted subsequent fastener may be driven, possibly causing injury.
  5. Hold the tool firmly against material to be fastened, otherwise fastener rebound can occur.
    - Be prepared for kickback; if the fastener strikes something hard like a knot or another fastener, the tool can recoil towards you.
    - Remove fasteners from tool after use.
    - Never point the tool at anyone.
    - Never disconnect the hose with your finger on the trigger, because there is a chance that the next time the hose is connected, the tool could fire spontaneously, or operate incorrectly.
  6. Use in a safe environment.
    - Do not expose compressor, air regulator or tool to long periods of direct sunlight.
    - Allow only authorized people to use your pneumatic tools.
    - Pay attention to the those around you--never permit horse play around or with the tool.
    - Be careful of sparks; never use the pneumatic tool around flammable liquids or combustible materials.
  7. Be careful with pressure
    - Never exceed recommended air pressure.
    - Make sure the hose is securely fastened into the coupler and that the air fitting is securely seated in the tool.
    - Use only compressed air -- using any other kind of gas mixture is very dangerous.
  8. Be careful with thin work materials and corners; a fastener could pass right through.
    - Don't use pneumatic tools on both sides of the same work surface simultaneously.
    - In elevated locations, secure the hose to a point near the location where you are working and don't work while moving backwards.
- Note: When using single trip mechanism, the operator must depress the push lever against the workpiece and then pull the trigger. This must be repeated each time to drive a fastener.

## III Special Safety Precautions For Pneumatic Tools

### IMPORTANT SAFETY INFORMATION

Read and understand tool labels and all of the operating instructions, safety precautions before operating or maintaining a pneumatic nailer. Failure to follow warnings could result in DEATH or SERIOUS INJURY. Most accidents that result from the operation and maintenance of Nailers are caused by the failure to observe basic safety rules or precautions. An accident can often be avoided by recognizing a potentially hazardous situation before it occurs, and by observing appropriate safety procedures.

Some Hitachi nailers have standard contact trip mechanisms (Bounce Fire):

An optional sequential trip kit (single shot) is available. To order a kit locate the appropriate part number listed next to each tool and call:

USA 1-800-706-7337 Canada 1-800-970-2299



## IV Hitachi Pneumatic Recommendations

- Use an oiler, filter, and air regulator\* so that equipment can be operated under an optimum condition to ensure extended service life. It is advisable to use an air system that:
  - Automatically supplies the proper amount of clean lubricant;
  - Filters the moisture and dust mixed with the compressed air; and
  - Regulates the pressure to a fixed level with a reducing valve (\*Do not use more than 10 feet of hose between the compressor and regulator.)
- Use the proper air hose with the correct inside diameter (see individual tool instruction manual) and working pressure.
 

The hose should have a working pressure of 150% of the maximum pressure supplied from the compressor. Hitachi recommends an air hose with an inside diameter of 3/8" and a minimum working pressure of 250 psi. (part #19400 or #19406)
- Drain the compressor tanks daily. Even when using filters or dryers, this is an important step to avoid accelerated corrosion.
- Use the proper tool lubricant. Hitachi pneumatic tool lubricant is recommended. (summer – part #19205, winter – part #19213)
- Check the air pressure. The air pressure must be constantly maintained at 70-120 psi. Pay close attention to the output pressure, capacity, and piping on the air supply system so that air pressure doesn't effect overall performance, service life, and safety.
- These recommendations also apply to industrial air systems. Regular maintenance and duties are frequently not performed on permanently installed air supply systems resulting in poor tool performance and work quality.

## V Hitachi Pneumatic Quality

Hitachi pneumatic tools are designed and manufactured specifically for durability, quality, and performance. By incorporating a simple overall design, tough components, and lightweight construction, Hitachi pneumatic tools require less maintenance, have fewer breakdowns and cause less fatigue.

Hitachi pneumatics are engineered to drive a fastener using only three major moving parts during the firing cycle. By using only the exhaust valve, cylinder, and driver blade, the tools will have less wear. This simple design is combined with specifically formulated component materials.

Common replacement parts such as driver blades are

metallurgically designed to be strong and hard yet shatterproof or resilient enough to absorb all excess force. Industry dealers and service centers report that they seldom encounter broken driver blades or piston bumpers that are in need of replacement even after years in the field and after firing millions of fasteners in all environmental conditions.

Hitachi has also designed our pneumatic tools to be more efficient by taking some of the wear and tear away from compressors and the users themselves. Extremely simple air flow inside the tool involving the "drop-sleeve" cylinder, exhaust cycle firing and stored air recovery allow our tools to fire quicker and require less air. Hitachi pneumatics are extremely fast

and capable of driving up to 3 nails or 5 staples per second. Lower air consumption will require less run or recovery by the compressor or allow additional tools to be used simultaneously. Hitachi pneumatic tool users can work quicker and more efficiently if they are not waiting on air.

The quality engineering that is found in Hitachi pneumatic tools does not stop with the major components. The precision continues with details like depth of drive adjustment mechanisms, virtually jam-proof feeding mechanisms, sophisticated nose pieces, toenail safety levers, and easy-load magazines. There are plenty more too, and all of them are designed to make the job easier.

## VI PLEASE READ THIS IMPORTANT INFORMATION REGARDING FASTENER CORROSION, AND WOOD

GALVANIZING HELPS, HOWEVER.....  
Salt air, High humidity, Industrial fumes and Driver blade impact can break down the zinc coating and the fasteners may rust.

ALSO...  
When wet, the tannin acid in cedar and redwood can react with the plating to create dark stains.

Preservatives and fire retardants in wood may contain salts corrosive to the fasteners.

THEREFORE...  
Limited Protection : Electrogalvanized  
Better : Hot dip galvanized  
Best : Stainless steel

Only Hot dip galvanized and Stainless Steel fasteners should be used in treated wood, cedar, redwood and exposed exterior applications.

GALVANIZED PRODUCTS CARRY NO WARRANTY EXPRESSED OR IMPLIED

## VII Extension Cord Chart

The use of improper extension cords will cause a serious voltage drop, power loss, motor damage, and possible fire. As the cord length is longer and the wire gauge is thinner, the voltage drop is greater. Therefore, a heavier gauge wire and a shorter cord is recommended. Please refer to this chart to choose the correct extension cord with a suitable wire size for the cord length and tool's rated amperage on the nameplate.

Extension Cord Length	Rated Ampere of Tool					
	0-2	2.1-3.4	3.5-5	5.1-7	7.1-12	12.1-16
25 Feet	18	18	18	18	16	14
50 Feet	18	18	18	16	14	12
75 Feet	18	18	16	14	12	10
100 Feet	18	16	14	12	10	8
150 Feet	16	14	12	10	8	8
200 Feet	16	14	12	10	8	6

(Based on limiting line voltage drop to 5V)





A Brand Within the Hitachi Power Tools Group

Tanaka Power Equipment is a Brand within the Hitachi Power Tools Group.

Tanaka's innovative product line provides landscapers, construction professionals, property managers, and utility professionals with two-stroke commercial grade outdoor power equipment solutions.

The well-established Tanaka brand offers a complete suite of grass trimmers, brush cutters, multi-task tools, chainsaws, blowers, hedge trimmers, edgers, augers, gas-powered drills, water pumps and a complete mix of accessories.

Tanaka was the first manufacturer to meet the CARB Tier II emissions standard in 1998 with its PureFire two-stroke engine technology. The line features an industry leading seven year consumer use warranty, two year commercial use warranty and one year rental use warranty.



Visit our website at [www.tanakapowerequipment.com](http://www.tanakapowerequipment.com) | or call 1.800.829.4752



# HITACHI

Inspire the Next



Visit us at [www.hitachipowertools.com](http://www.hitachipowertools.com)

## PRODUCTS

Complete specifications, features and benefits, warranty information, related accessories and literature

## RETAILERS

Locate Hitachi's nearest retail partners

## SERVICE CENTERS

Order parts or find the nearest service center

## HITACHI GEAR

Order the latest Hitachi apparel, golf accessories and corporate items



Join us on [facebook.com/hitachipowertools](https://facebook.com/hitachipowertools)



Check out demos of the latest tools at the Hitachi Tool Corner on YouTube

[www.youtube.com/user/HitachiToolCorner1](http://www.youtube.com/user/HitachiToolCorner1)

Please visit our website at  
[www.hitachipowertools.com](http://www.hitachipowertools.com)

For the dealer nearest you, call  
1.800.546.1666

For more information, call or email  
1.800.706.7337  
[reachcustomerservice@hitachi-powertools.com](mailto:reachcustomerservice@hitachi-powertools.com)

For technical service, call  
1.866.775.9429

**Hitachi Koki, USA, Ltd.**  
3950 Steve Reynolds Blvd.  
Norcross, GA 30093

**Hitachi Koki, Ltd.**  
Shinagawa Intercity Tower A  
15-1, Konan 2-chome  
Minato-ku, Tokyo 108-6020, Japan